



■ Features

- Compliance to BS EN/EN50155 and BS EN/EN45545-2 railway standard
- Width only 32mm
- 2:1 wide input range
- -40~+70°C wide working temperature
- 150% peak load capability
- DC output adjustable
- Cooling by free air convection
- Can be installed on DIN rail TS-35/7.5 or 15
- Protections: Short circuit / Overload / Over voltage / Input reverse polarity / Input under voltage protection
- 4KVdc I/O isolation(Reinforced isolation)
- 3 years warranty

■ Description

DDR-120 series is a 120W DIN Rail type DC-DC converter with main features including DIN rail-type easy installation, ultra slim width (32mm), 2:1 wide input voltage, fanless design, -40~+70°C wide operating temperature, 4KVdc I/O isolation, 150% peak load, adjustable output voltage and full protective functions.

This series of models has various input options: 9~18V / 16.8~33.6V / 33.6~67.2V / 67.2~154V and various output options: 12V / 24V / 48V and can be used for industrial & railway control, security control, communication system and other fields. Suitable applications include DC buck/boost regulator, increasing system insulation level and voltage drop compensation along cable...etc.

■ Model Encoding

DDR - 120 **A** - **24**

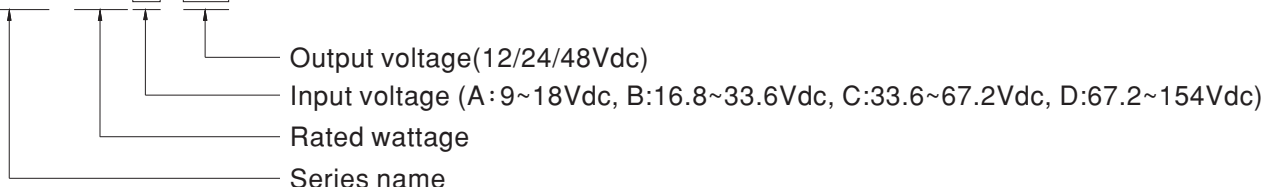

■ Applications

- Bus, tram, metro or railway system
- Industrial control system
- Semi-conductor fabrication equipment
- Factory automation
- Electro-mechanical
- Wireless network
- Telecom or datacom system



SPECIFICATION

MODEL		DDR-120A-12	DDR-120A-24	DDR-120A-48	DDR-120B-12	DDR-120B-24	DDR-120B-48
OUTPUT	DC VOLTAGE	12V	24V	48V	12V	24V	48V
	RATED CURRENT	8.3A	4.2A	2.1A	10A	5A	2.5A
	CURRENT RANGE	0 ~ 8.3A	0 ~ 4.2A	0 ~ 2.1A	0 ~ 10A	0 ~ 5A	0 ~ 2.5A
	RATED POWER	99.6W	100.8W	100.8W	120W	120W	120W
	PEAK CURRENT	12.45A	6.3A	3.15A	15A	7.5A	3.75A
	PEAK POWER Note.5	150W (3sec.)			180W (3sec.)		
	RIPPLE & NOISE (max.) Note.2	50mVp-p	50mVp-p	50mVp-p	50mVp-p	50mVp-p	50mVp-p
	VOLTAGE ADJ. RANGE	9 ~ 14V	24 ~ 28V	48 ~ 56V	9 ~ 14V	24 ~ 28V	48 ~ 56V
	VOLTAGE TOLERANCE Note.3	± 1.0%	± 1.0%	± 1.0%	± 1.0%	± 1.0%	± 1.0%
	LINE REGULATION	± 0.5%	± 0.5%	± 0.5%	± 0.5%	± 0.5%	± 0.5%
	LOAD REGULATION	± 1.0%	± 1.0%	± 1.0%	± 1.0%	± 1.0%	± 1.0%
SETUP, RISE TIME	500ms, 60ms @12Vdc			500ms, 60ms @24Vdc			
HOLD UP TIME (Typ.)	Please refer to page 7 Hold up Time(Load de-rating curve)						
INPUT	VOLTAGE RANGE Note.4	9 ~ 18Vdc	9 ~ 18Vdc	9 ~ 18Vdc	16.8 ~ 33.6Vdc	16.8 ~ 33.6Vdc	16.8 ~ 33.6Vdc
	EFFICIENCY (Typ.)	88.5%	88.5%	88.5%	89%	89.5%	91%
	DC CURRENT (Typ.)	11.2A @12Vdc			5.6A @24Vdc		
	INRUSH CURRENT (Typ.)	5A @12Vdc			5A @ 24Vdc		
	INTERRUPTION OF VOLTAGE SUPPLY	EN50155:2007-comply with 3ms@ full load EN50155:2017-comply with S1 level			EN50155:2007-comply with S1 level (6ms) @ full load, S2 level (10ms) @ 70% load EN50155:2017-comply with S1 level		
PROTECTION	OVERLOAD	Normally works within 150% rated output power for more than 3 seconds and then constant current protection 105~135% rated output power with auto-recovery					
	OVER VOLTAGE	14.4 ~ 16.8V	28.8 ~ 33.6V	57.6 ~ 67.2V	14.4 ~ 16.8V	28.8 ~ 33.6V	57.6 ~ 67.2V
	REVERSE POLARITY	By internal MOSFET, no damage, recovers automatically after fault condition removed					
	UNDER VOLTAGE LOCKOUT	12Vin (A - type) :Power ON ≥ 9V , OFF ≤ 8.5V			24Vin (B - type) :Power ON ≥ 16.8V , OFF ≤ 16.5V		
ENVIRONMENT	WORKING TEMP.	-40 ~ +70°C (Refer to "Derating Curve")					
	WORKING HUMIDITY	5 ~ 95% RH non-condensing					
	STORAGE TEMP., HUMIDITY	-40 ~ +85°C , 5 ~ 95% RH non-condensing					
	TEMP. COEFFICIENT	± 0.03%/°C (0 ~ 55°C)					
	VIBRATION	Component:10 ~ 500Hz, 5G 10min./1cycle, 60min. each along X, Y, Z axes; Mounting: Compliance to IEC61373					
	OPERATING ALTITUDE	5000 meters					
SAFETY & EMC (Note 6)	SAFETY STANDARDS	IEC 62368-1, UL 62368-1, EAC TP TC 004, AS/NZS 62368.1 approved; Design refer to UL508					
	WITHSTAND VOLTAGE	I/P-O/P:4KVdc I/P-FG:2.5KVdc O/P-FG:2.5KVdc					
	ISOLATION RESISTANCE	I/P-O/P, I/P-FG, O/P-FG:>100M Ohms / 500Vdc / 25°C / 70% RH					
	EMC EMISSION	Parameter	Standard		Test Level / Note		
		Conducted	BS EN/EN55032		Class B		
		Radiated	BS EN/EN55032		Class B		
		Voltage Flicker	BS EN/EN61000-3-3		-----		
		Harmonic Current	-----		-----		
	EMC IMMUNITY	BS EN/EN55024 , BS EN/EN61000-6-2(BS EN/EN50082-2)					
		Parameter	Standard		Test Level / Note		
		ESD	BS EN/EN61000-4-2		Level 3, 8KV air ; Level 3, 6KV contact; criteria A		
		Radiated	BS EN/EN61000-4-3		Level 3, 10V/m ; criteria A		
		EFT / Burst	BS EN/EN61000-4-4		Level 3, 2KV ; criteria A		
		Surge	BS EN/EN61000-4-5		Level 3, 1KV/Line-Line ;Level 3, 2KV/Line-Line-FG ;criteria A		
Conducted		BS EN/EN61000-4-6		Level 3, 10V ; criteria A			
Magnetic Field	BS EN/EN61000-4-8		Level 4, 30A/m ; criteria A				
RAILWAY STANDARD	Compliance to BS EN/EN45545-2 for fire protection ; Meet BS EN/EN50155 / IEC60571 including IEC61373 for shock & vibration, BS EN/EN50121-3-2 for EMC (except for 9~18Vin)						
OTHERS	MTBF	214.6K hrs min. MIL-HDBK-217F (25°C)					
	DIMENSION	32*125.2*102mm (W*H*D)					
	PACKING	510g; 28pcs/15.3Kg/1.22CUFT					
NOTE	<p>1. All parameters NOT specially mentioned are measured at normal input (A:12Vdc , B:24Vdc) , rated load and 25°C of ambient temperature.</p> <p>2. Ripple & noise are measured at 20MHz of bandwidth by using a 12" twisted pair-wire terminated with a 0.1 μ f & 47 μ f parallel capacitor.</p> <p>3. Tolerance : includes set up tolerance, line regulation and load regulation.</p> <p>4. Derating may be needed under low input voltage. Please check the derating curve for more details.</p> <p>5. 3 seconds max., please refer to peak loading curves.</p> <p>6. The power supply is considered as an independent unit, but the final equipment still need to re-confirm that the whole system complies with the EMC directives. For guidance on how to perform these EMC tests, please refer to "EMI testing of component power supplies." (as available on http://www.meanwell.com)</p> <p>7. The ambient temperature derating of 3.5°C/1000m with fanless models and of 5°C/1000m with fan models for operating altitude higher than 2000m(6500ft).</p> <p>※ Product Liability Disclaimer : For detailed information, please refer to https://www.meanwell.com/serviceDisclaimer.aspx</p>						



SPECIFICATION

MODEL	DDR-120C-12	DDR-120C-24	DDR-120C-48	DDR-120D-12	DDR-120D-24	DDR-120D-48			
OUTPUT	DC VOLTAGE	12V	24V	48V	12V	24V	48V		
	RATED CURRENT	10A	5A	2.5A	10A	5A	2.5A		
	CURRENT RANGE	0 ~ 10A	0 ~ 5A	0 ~ 2.5A	0 ~ 10A	0 ~ 5A	0 ~ 2.5A		
	RATED POWER	120W	120W	120W	120W	120W	120W		
	PEAK CURRENT	15A	7.5A	3.75A	15A	7.5A	3.75A		
	PEAK POWER	Note.5 180W (3sec.)							
	RIPPLE & NOISE (max.)	Note.2 50mVp-p							
	VOLTAGE ADJ. RANGE	9 ~ 14V	24 ~ 28V	48 ~ 56V	9 ~ 14V	24 ~ 28V	48 ~ 56V		
	VOLTAGE TOLERANCE	Note.3 ± 1.0%							
	LINE REGULATION	± 0.5%							
	LOAD REGULATION	± 1.0%							
SETUP, RISE TIME	500ms, 60ms @48Vdc			500ms, 60ms @110Vdc					
HOLD UP TIME (Typ.)	Please refer to page 7 Hold up Time(Load de-rating curve)								
INPUT	VOLTAGE RANGE	Note.4 33.6 ~ 67.2Vdc		33.6 ~ 67.2Vdc		33.6 ~ 67.2Vdc	67.2 ~ 154Vdc	67.2 ~ 154Vdc	67.2 ~ 154Vdc
	EFFICIENCY (Typ.)	89.5%		91%		92%	89.5%	91%	91.5%
	DC CURRENT (Typ.)	2.8A @48Vdc			1.3A @110Vdc				
	INRUSH CURRENT (Typ.)	5A @48Vdc			5A @110Vdc				
	INTERRUPTION OF VOLTAGE SUPPLY	EN50155:2007-comply with S1 level (6ms) @ full load, S2 level (10ms) @ 60% load EN50155:2017-comply with S1 level			EN50155:2007-comply with S2 level (10ms) @ full load EN50155:2017-comply with S1 level				
PROTECTION	OVERLOAD	Normally works within 150% rated output power for more than 3 seconds and then constant current protection 105~135% rated output power with auto-recovery							
	OVER VOLTAGE	14.4 ~ 16.8V	28.8 ~ 33.6V	57.6 ~ 67.2V	14.4 ~ 16.8V	28.8 ~ 33.6V	57.6 ~ 67.2V		
	REVERSE POLARITY	By internal MOSFET, no damage, recovers automatically after fault condition removed							
	UNDER VOLTAGE LOCKOUT	48Vin (C - type) :Power ON ≥ 33.6V , OFF ≤ 33V			110Vin (D - type) :Power ON ≥ 67.2V , OFF ≤ 65V				
ENVIRONMENT	WORKING TEMP.	-40 ~ +70°C (Refer to "Derating Curve")							
	WORKING HUMIDITY	5 ~ 95% RH non-condensing							
	STORAGE TEMP., HUMIDITY	-40 ~ +85°C , 5 ~ 95% RH non-condensing							
	TEMP. COEFFICIENT	± 0.03%/°C (0 ~ 55°C)							
	VIBRATION	Component:10 ~ 500Hz, 5G 10min./1cycle, 60min. each along X, Y, Z axes; Mounting: Compliance to IEC61373							
SAFETY & EMC (Note 6)	OPERATING ALTITUDE	5000 meters							
	SAFETY STANDARDS	IEC 62368-1, UL 62368-1, EAC TP TC 004, AS/NZS 62368.1 approved; Design refer to UL508							
	WITHSTAND VOLTAGE	I/P-O/P:4KVdc I/P-FG:2.5KVdc O/P-FG:2.5KVdc							
	ISOLATION RESISTANCE	I/P-O/P, I/P-FG, O/P-FG:>100M Ohms / 500Vdc / 25°C / 70% RH							
	EMC EMISSION	Parameter	Standard		Test Level / Note				
		Conducted	BS EN/EN55032		Class B				
		Radiated	BS EN/EN55032		Class B				
		Voltage Flicker	BS EN/EN61000-3-3		-----				
		Harmonic Current	-----		-----				
	EMC IMMUNITY	BS EN/EN55024 , BS EN/EN61000-6-2(BS EN/EN50082-2)							
		Parameter	Standard		Test Level / Note				
ESD		BS EN/EN61000-4-2		Level 3, 8KV air ; Level 3, 6KV contact; criteria A					
Radiated		BS EN/EN61000-4-3		Level 3, 10V/m ; criteria A					
EFT / Burst		BS EN/EN61000-4-4		Level 3, 2KV ; criteria A					
Surge		BS EN/EN61000-4-5		Level 3, 1KV/Line-Line ;Level 3, 2KV/Line-Line-FG ;criteria A					
Conducted		BS EN/EN61000-4-6		Level 3, 10V ; criteria A					
Magnetic Field	BS EN/EN61000-4-8		Level 4, 30A/m ; criteria A						
RAILWAY STANDARD	Compliance to BS EN/EN45545-2 for fire protection ; Meet BS EN/EN50155 / IEC60571 including IEC61373 for shock & vibration, BS EN/EN50121-3-2 for EMC								
OTHERS	MTBF	214.6K hrs min. MIL-HDBK-217F (25°C)							
	DIMENSION	32*125.2*102mm (W*H*D)							
	PACKING	510g; 28pcs/15.3Kg/1.22CUFT							

NOTE

- All parameters NOT specially mentioned are measured at normal input (C:48Vdc , D:110Vdc) , rated load and 25°C of ambient temperature.
- Ripple & noise are measured at 20MHz of bandwidth by using a 12" twisted pair-wire terminated with a 0.1 μf & 47 μf parallel capacitor.
- Tolerance : includes set up tolerance, line regulation and load regulation.
- Derating may be needed under low input voltage. Please check the derating curve for more details.
- 3 seconds max., please refer to peak loading curves.
- The power supply is considered as an independent unit, but the final equipment still need to re-confirm that the whole system complies with the EMC directives. For guidance on how to perform these EMC tests, please refer to "EMI testing of component power supplies." (as available on <http://www.meanwell.com>)
- The ambient temperature derating of 3.5°C/1000m with fanless models and of 5°C/1000m with fan models for operating altitude higher than 2000m(6500ft).

※ Product Liability Disclaimer : For detailed information, please refer to <https://www.meanwell.com/serviceDisclaimer.aspx>

■ Block Diagram

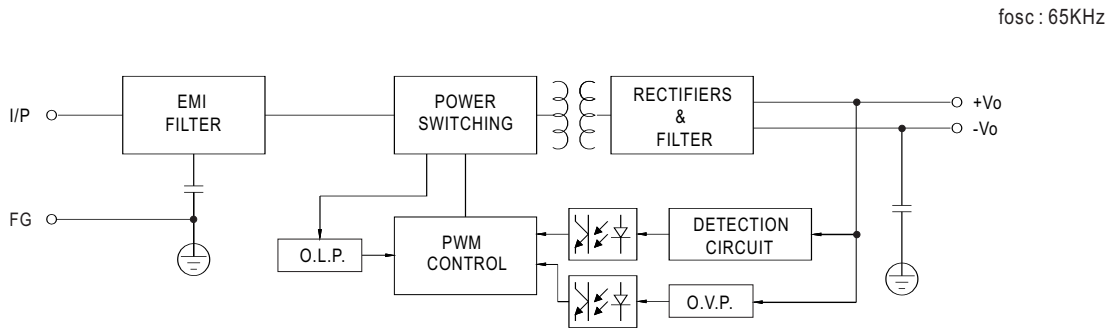

■ Derating Curve

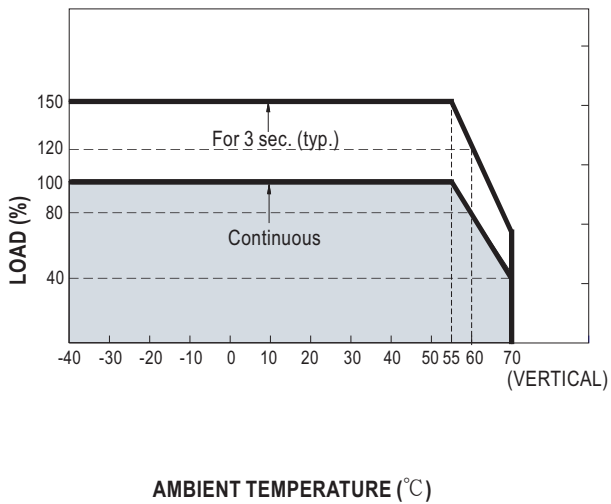

■ Output derating VS input voltage

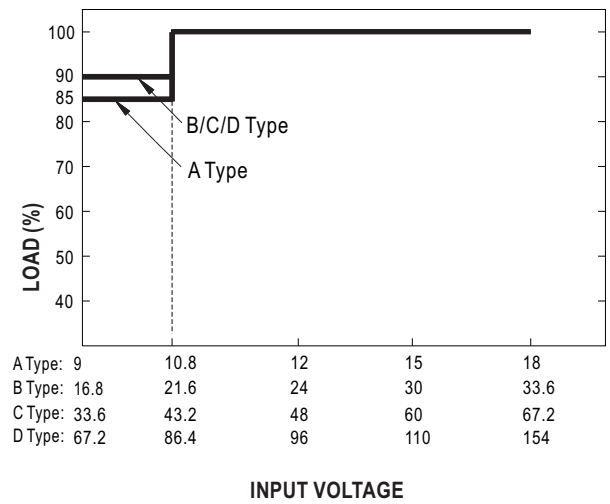

■ Peak Loading

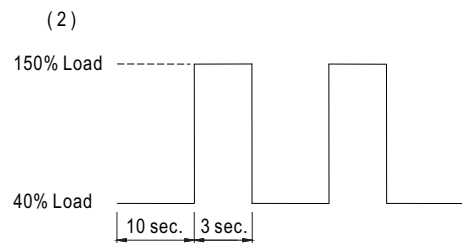
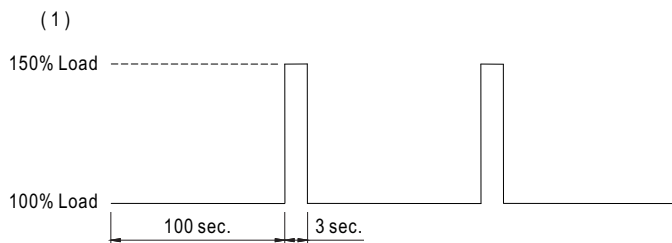

Input Fuse

There is a fuse connected in series to the positive input line, which is used to protect against abnormal surge. Fuse specifications of each model are shown as below.

Type	Fuse Type	Reference and Rating
A	Time-Lag	Conquer MST, 10A, 250V *2
B	Time-Lag	Conquer MST, 8A, 250V *2
C	Time-Lag	Conquer MST, 8A, 250V *1
D	Time-Lag	Conquer MST, 4A, 250V *1

Input Under-Voltage Protection

If input voltage drops below V_{imin} , the internal control IC shuts down and there is no output voltage. It recovers automatically when input voltage reaches above V_{imin} , please refer to the curve below.

DDR-120A-24

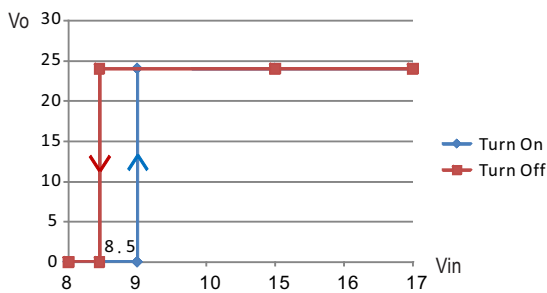

DDR-120B-24

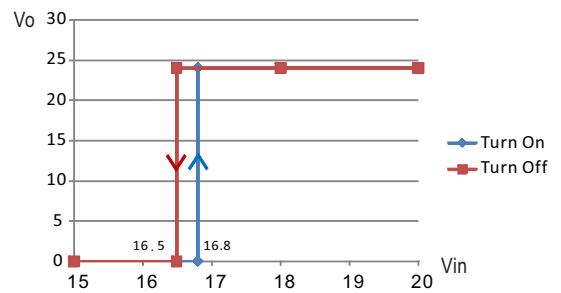

DDR-120C-24

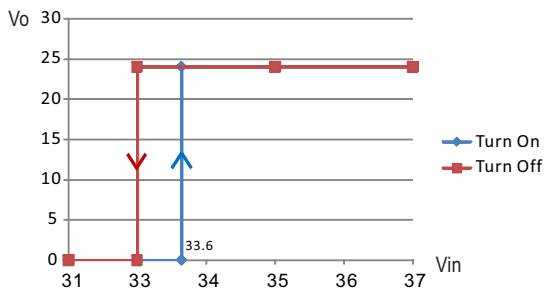

DDR-120D-24

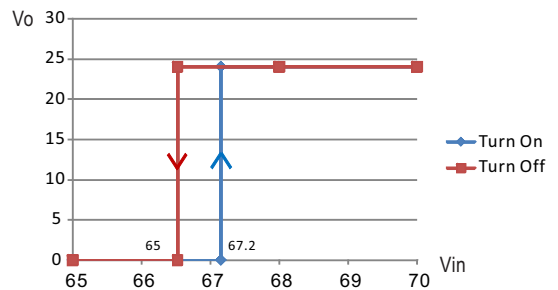

■ Input Reverse Polarity Protection

There is a MOSFET connected in series to the negative input line. If the input polarity is connected reversely, the MOSFET opens and there will be no output to protect the unit.

■ Input Range and Transient Ability

The series has a wide range input capability. With -30% / +40% of rated input voltage(except A Type), it can withstand that for 1 second.

■ Inrush Current

Inrush current is suppressed by a current limit circuit during the initial start-up, and then the circuit is bypassed by a MOSFET to reduce power consumption after accomplishing the start-up.

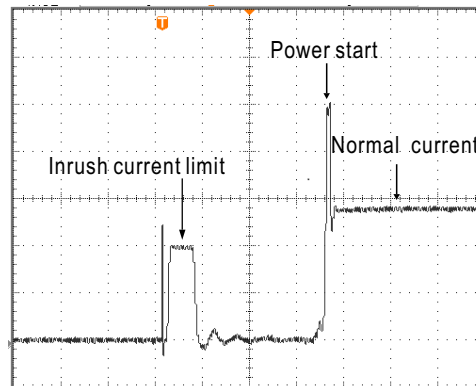

Hold-up Time

- EN50155: 2007 version -D type is in compliance with S2 level (10ms), while A types are in compliance with S1 level (3ms) at full load output condition. To fulfil the requirements of S2 level (10ms), B types require de-rating their output load to 70%, C types require de-rating their output load to 60%, please refer to the curve diagrams below.

DDR-120A-12

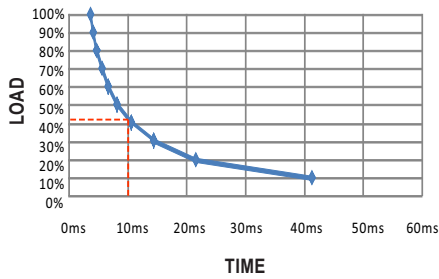

DDR-120A-24

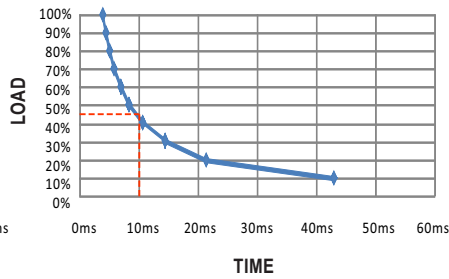

DDR-120A-48

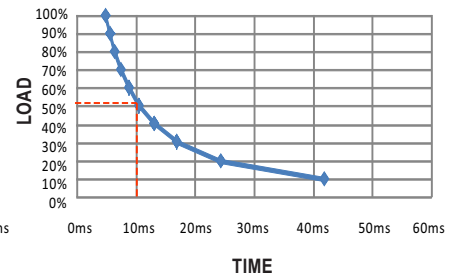

DDR-120B-12

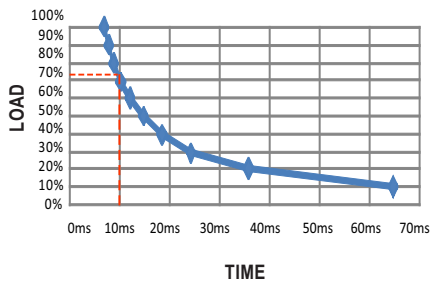

DDR-120B-24

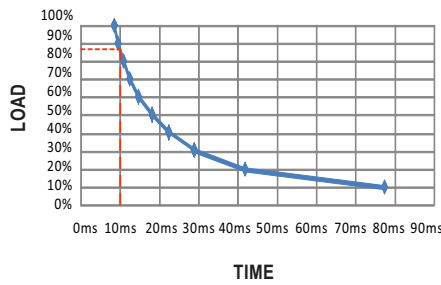

DDR-120B-48

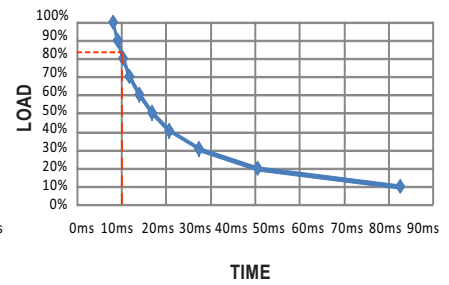

DDR-120C-12

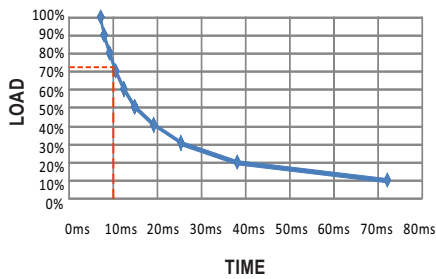

DDR-120C-24

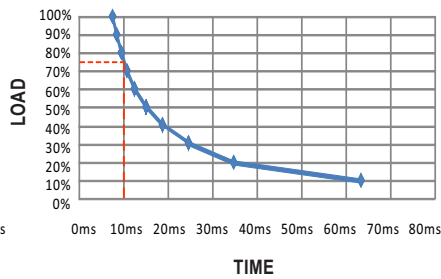

DDR-120C-48

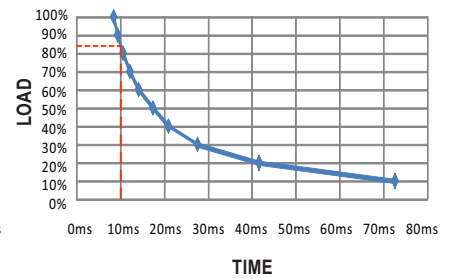

DDR-120D-12

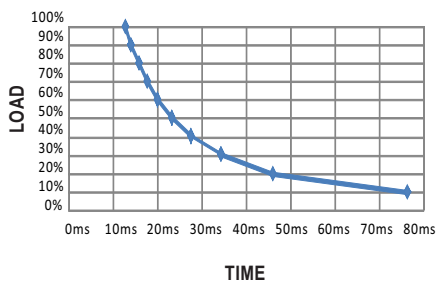

DDR-120D-24

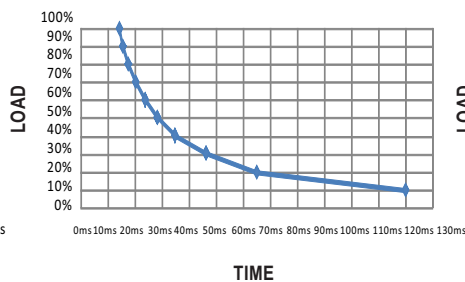

DDR-120D-48

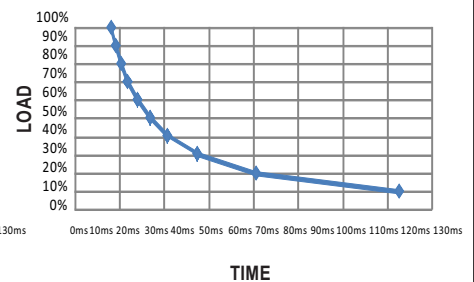

- EN50155: 2017 version - Comply with S1 level (6ms)

Efficiency vs Load & Vin Curve

The efficiency vs load & Vin curves of each model are shown as below.

DDR-120A-12

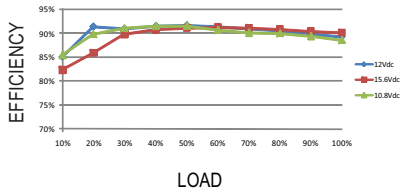

DDR-120A-24

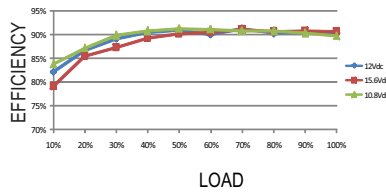

DDR-12A-48

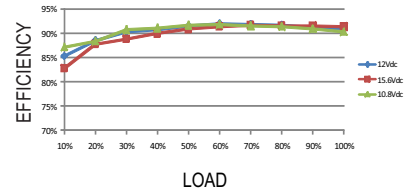

DDR-120B-12

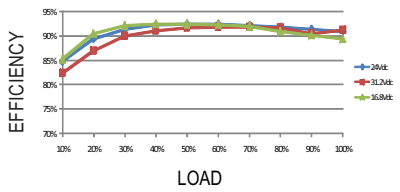

DDR-120B-24

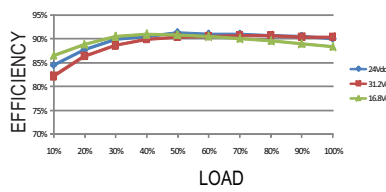

DDR-120B-48

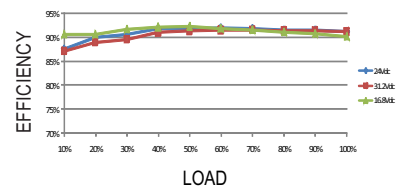

DDR-120C-12

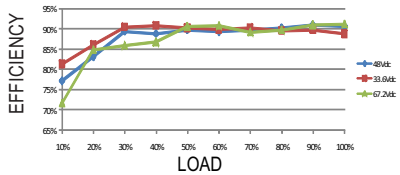

DDR-120C-24

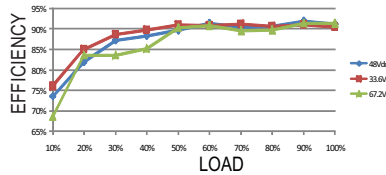

DDR-120C-48

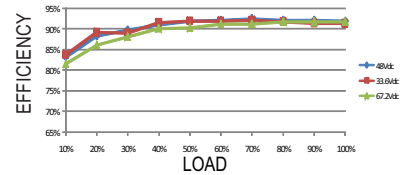

DDR-120D-12

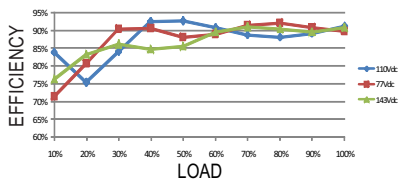

DDR-120D-24

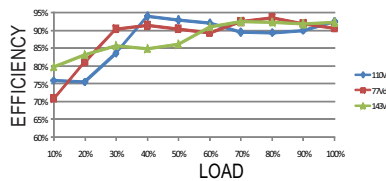

DDR-120D-48

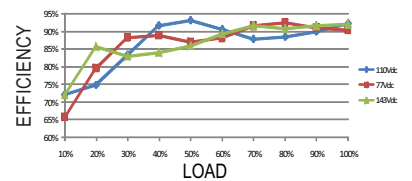

Immunity to Environmental Conditions

Test method	Standard	Test conditions	Status
Cooling Test	EN 50155 section 12.2.3 (Column 2, Class TX) EN 60068-2-1	Temperature: -40°C Dwell Time: 2 hrs/cycle	No damage
Dry Heat Test	EN 50155 section 12.2.4 (Column 2, Class TX) EN 50155 section 12.2.4 (Column 3, Class TX & Column 4, Class TX) EN 60068-2-2	Temperature: 70°C / 85°C Duration: 6 hrs / 10min	PASS
Damp Heat Test, Cyclic	EN 50155 section 12.2.5 EN 60068-2-30	Temperature: 25°C~55°C Humidity: 90%~100% RH Duration: 48 hrs	PASS
Vibration Test	EN 50155 section 12.2.11 EN 61373	Temperature: 19°C Humidity: 65% Duration: 10 mins	PASS
Increased Vibration Test	EN 50155 section 12.2.11 EN 61373	Temperature: 19°C Humidity: 65% Duration: 5 hrs	PASS
Shock Test	EN 50155 section 12.2.11 EN 61373	Temperature: 21 ± 3°C Humidity: 65 ± 5% Duration: 30ms*18	PASS
Low Temperature Storage Test	EN 50155 section 12.2.3 (Column 2, Class TX) EN 60068-2-1	Temperature: -40°C Dwell Time: 16 hrs	PASS
Salt Mist Test	EN 50155 section 12.2.10 (Class ST4)	Temperature: 35°C ± 2°C Duration: 96 hrs	PASS

EN45545-2 Fire Test Conditions

Test Items		Hazard Level			
	Items	Standard	HL1	HL2	HL3
R22	Oxygen index test	EN 45545-2:2013 EN ISO 4589-2:1996	PASS	PASS	PASS
	Smoke density test	EN 45545-2:2013 EN ISO 5659-2:2006	PASS	PASS	PASS
	Smoke toxicity test	EN 45545-2:2013 NF X70-100:2006	PASS	PASS	PASS
R24	Oxygen index test	EN 45545-2:2013 EN ISO 4589-2:1996	PASS	PASS	PASS
R25	Glow-wire test	EN 45545-2:2013 EN 60695-2-11:2000	PASS	PASS	PASS
R26	Vertical flame test	EN 45545-2:2013 EN 60695-11:2003	PASS	PASS	PASS

Mechanical Specification

Case No. Unit:mm

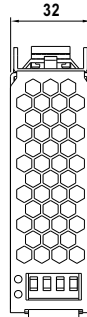

Top View

Terminal Pin No. Assignment (TB2)

Pin No.	Assignment
1,2	DC Output -Vo
3,4	DC Output +Vo

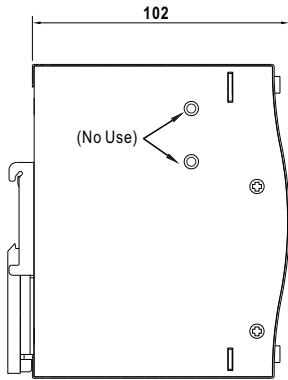

Side View

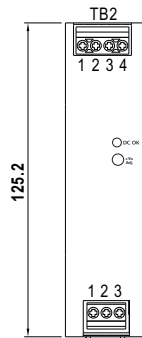

Front View

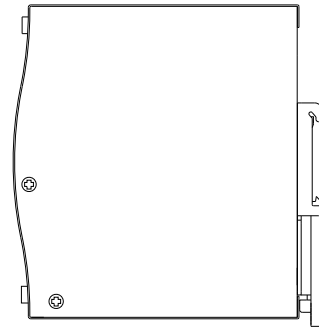

Side View

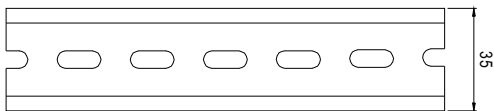

ADMISSIBLE DIN-RAIL: TS35/7.5 OR TS35/15

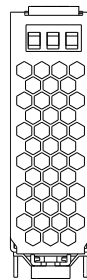

Bottom View

Terminal Pin No. Assignment (TB1)

Pin No.	Assignment
1	FG ⚡
2	DC Input -Vin
3	DC Input +Vin

Installation Manual

Please refer to : <http://www.meanwell.com/manual.html>