

New U-series compact network camera with enhanced functions and affordability

4MP Indoor Dome Network Camera

The new U series is an entry model that achieves high quality and reliability at an affordable price to meet the needs of a wide range of customers. The compact and slim design allows it to be installed in a various locations.

It newly supports ONVIF G / S / T profile and H.265 / H.264, and can be widely used for connecting various VMS and recorders. It also comes pre-installed with secure certificates, enabling device authentication and end-to-end communication encryption to counter the threat of advanced cyberattacks.

Key features

- Compact and slim design allows installation in various locations
- Compliant with ONVIF G / S / T profile and H.265 / H.264, and can support a wide range of connections to VMS and recorders
- Uses "Easy Kitting Packing" that allows you to set the camera without removing it from the box
- Strengthen cyber security by pre-installing digital certificates issued by a third party organization (GlobalSign)

Key i-PRO Spec.

- 5MP Sensor
- 2688×1520 pixel image up to 30fps
- iA (intelligent Auto)
- Super Dynamic 102dB
- Color night vision (0.019 to 0.3 lx)
- H.265 Smart Coding
- Corridor mode
(90 degrees or 270 degrees in image rotation)
- Built-in IR LED
- ONVIF Profile G / S / T

Industry examples

- Retail
- Education
- Public safety
- Bank / Hospital / Building



■ ■ ■ ■ ■ PRO

Specifications

Camera	Image Sensor	Approx. 1/2.7 type CMOS image sensor	
	Effective pixels	Approx. 5.2 megapixels, 2688(H)×1944(V)	
	Minimum Illumination	Color : 0.3 lx, BW : 0.12 lx (50IRE, F2.0, Maximum shutter : Off (1/30s), AGC : 11) BW : 0 lx (50IRE, F2.0, Maximum shutter : Off (1/30 s), AGC : 11, when the IR LED is lit) Color : 0.019 lx, BW : 0.0075 lx (50IRE, F2.0, Maximum shutter : max. 16/30s, AGC : 11) *1	
	White Balance	ATW1/ ATW2/ AWC	
	Maximum shutter	[30fps mode] Max. 1/10000 s to Max. 16/30 s [25fps mode] Max. 1/10000 s to Max. 16/25 s	
	Intelligent Auto	On / Off	
	Super Dynamic	On / Off, The level can be set in the range of 0 to 31.	
	Dynamic Range	Max. 102 dB (Super Dynamic : On, Level: 31)	
	Adaptive Black Stretch	The level can be set in the range of 0 to 255.	
	Back light compensation / High light compensation	BLC (Back light compensation) / HLC (High light compensation) / Off The level can be set in the range of 0 to 31. (only when Super dynamic / Intelligent Auto : Off)	
	Fog compensation	On / Off, The level can be set in the range of 0 to 8. (only when Intelligent auto / auto contrast adjust: Off)	
	Maximum gain (AGC)	The level can be set in the range of 0 to 11.	
	Color/BW (ICR)	Off / On (IR Light Off) / On (IR Light On) / Auto1 (IR Light Off) / Auto2 (IR Light On) / Auto3 (SCC)	
	IR LED Light	High / Middle / Low / Off, Maximum irradiation distance : 20 m (Approx. 65 ft)	
	Digital Noise Reduction	The level can be set in the range of 0 to 255.	
	Video Motion Detection (VMD)	On / Off, 4 areas available	
	Scene Change Detection (SCD)	On / Off, 1 area available	
	Privacy Zone	On / Off, Up to 8 zones available	
	VIQS	On / Off, Up to 8 zones available	
	Image rotation*2	0° (Off) / 90° / 180° (Upside-down) / 270°	
	Camera Title (OSD)	On / Off, Up to 20 characters (alphanumeric characters, marks)	
	Lens	Focal length	3.2 mm{1/8 inches}
		Optical zoom	1x
		Extra zoom	1.0x - 1.3x(when resolution is 1920x1080)
		Digital (electronic) zoom	Choose from 3 levels of x1, x2, x4
Angular Field of View		[16 : 9 mode] *{4:3 mode} is not supported. Horizontal : 100° Vertical : 54°	
Maximum Aperture Ratio		1 : 2.0	
Focusing Range		1 m {39-3/8 inches} - ∞	
DORI	Detect (25ppm / 8ppf)	43.0 m / 141.0 ft	
	Observe (62.5ppm / 19ppf)	17.2 m / 56.4 ft	
	Recognize (125ppm / 38ppf)	8.6 m / 28.2 ft	
	Identify (250ppm / 76ppf)	4.3 m / 14.1 ft	
Adjusting Angle	Horizontal (PAN) angle	-175 ° - +175 °, Vertical (TILT) angle: -30 ° - +80 °	
	Azimuth (YAW) angle	±100°	
Browser GUI	Camera Control	Brightness	
	GUI / Setup Menu Language	English, Italian, French, German, Spanish, Portuguese, Russian, Chinese, Japanese	

Network	Network IF	10Base-T / 100Base-TX, RJ45 connector				
	Resolution	[16:9 mode(2688x1520 30fps mode)], [16:9 mode(2688x1520 25fps mode)] 2688×1520, 1920×1080, 640×360, 320×180				
	H.265/H.264	[16:9 mode(30fps mode)], [16:9 mode(25fps mode)] 2560×1440, 1920×1080, 640×360, 320×180 *[4:3 mode] is not supported.				
	H.265/H.264	Transmission Mode	Constant bit rate / VBR / Frame rate / Best effort			
		Transmission Type	Unicast port(AUTO) / Unicast port(MANUAL) / Multicast			
	Max. frame rate for each stream*3	Stream(1)	Stream(2)	Stream(3)	JPEG(1)	JPEG(2)
		2688x1520(30fps)	Off	Off	2560x1440(1fps)	1920x1080(1fps)
		2560x1440(30fps)	640x360(30fps)	Off	2560x1440(1fps)	1920x1080(1fps)
	JPEG	Image Quality	10 steps			
	Smart Coding	GOP(Group of pictures) control: On(Frame rate control) / On(Advanced) / On(Mid.) / On(Low) / Off *Frame rate control and Advanced are only available with H.265. AUTO VIQS: On/ Off				
	Audio Compression	—				
	Audio transmission mode	—				
	Supported Protocol	IPv6 : TCP/IP, UDP/IP, HTTP, HTTPS, SSL/TLS, SMTP, DNS, NTP, SNMPv1/v2/v3, DHCPv6, RTP, MLD, ICMP, ARP, IEEE 802.1X, DiffServ IPv4 : TCP/IP, UDP/IP, HTTP, HTTPS, SSL/TLS, RTSP, RTP, RTSP/RTCP, SMTP, DHCP, DNS, DDNS, NTP, SNMPv1/v2/v3, UPnP, IGMP, ICMP, ARP, IEEE 802.1X, DiffServ				
	No. of Simultaneous Users	Up to 14 users (Depends on network conditions)				
	SDXC/SDHC/SD Memory Card (Option)	H.265/H.264 recording: Manual REC / Alarm REC (Pre/Post) / Schedule REC Available SDXC/SDHC/SD Memory Card : microSDXC memory card: 64 GB, 128 GB, 256 GB, 512 GB microSDHC memory card: 4 GB, 8 GB, 16 GB, 32 GB microSD memory card: 2 GB				
Mobile Terminal Compatibility	iPad, iPhone, Android™ terminals					
ONVIF Profile	G / S / T					
Alarm	Alarm Source	VMD alarm, SCD alarm, Command alarm				
	Alarm Actions	SDXC/SDHC/SD memory recording, E-mail notification, HTTP alarm notification, Indication on browser, Panasonic alarm protocol output				
Input/ Output	Monitor Output (for adjustment)	—				
	Audio input	—				
	Audio Output	—				
	External I/O Terminals	—				
General	Safety	UL (UL60950-1), c-UL (CSA C22.2 No.60950-1), CE, IEC60950-1				
	EMC	FCC (Part15 ClassA), ICES003 ClassA, EN55032 ClassB, EN55024				
	Power Source and Power Consumption	PoE (IEEE802.3af compliant) Device : DC48 V 110 mA, Approx. 5.3 W (Class 2 device)				
	Ambient Operating Temperature	-10 °C to +50 °C (+14 °F to +122 °F) {Power On range: 0 °C to +50 °C (+32°F to +122 °F)}				
	Ambient Operating Humidity	10 to 90 % (no condensation)				
	Dimensions	ø109 mm x 62 mm (H) (ø4-9/32 inches x 2-7/16 inches (H)) Dome radius 30.5 mm (1-3/16 inches)				
	Mass (approx.)	250 g {0.55 lbs}				
	Finish	Main body : Aluminum die cast / Polycarbonate resin, I-PRO white Dome section : Polycarbonate resin, Clear				

*1 Converted value

*2 When "4:3(30fps mode)" or "4:3(25fps mode)" is selected for "Image capture mode", "90 °" and "270 °" cannot be selected.

*3 Smart Coding(GOP and AUTO VIQS) is not available when setting 30fps.





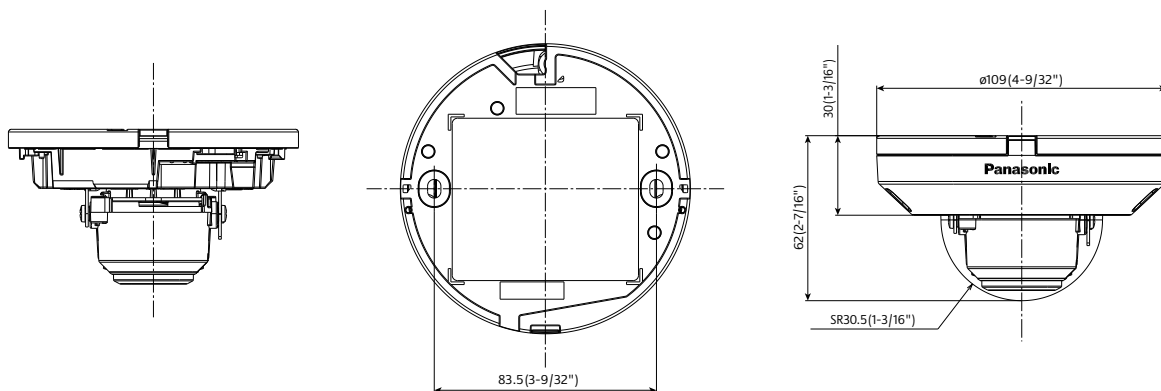





Appearance

Unit : mm (inches)



Optional Accessories

Mount Bracket / Other

	WALL		POLE	CORNER	HANGING	CEILING
	1	2	1	1	1	1
combination	Wall Mount Bracket WV-QWL500-W (i-PRO white) 	Base bracket WV-QJB502-W (i-PRO white) 	Pole Mount Bracket WV-QPL500-W (i-PRO white) 	Corner Mount Bracket WV-QCN500-W (i-PRO white) 	Ceiling Mount Bracket WV-QCL100-W *1 (i-PRO white) 	Base bracket WV-QJB502-W (i-PRO white) 
	Adapter Box WV-QJB500-W (i-PRO white)  *If needed.	/	Wall Mount Bracket WV-QWL500-W (i-PRO white) (+ WV-QJB500-W)  + 	Wall Mount Bracket WV-QWL500-W (i-PRO white) (+ WV-QJB500-W)  + 	3rd Parties Pipe	/

*1 : It's possible to be used on the camera side and ceiling side. If used on both side, 2pieces are required.

Dome Cover

Dome Cover (Smoke type)
WV-QDC500S



Trademarks and registered trademarks

- iPad and iPhone are trademarks of Apple Inc., registered in the U.S. and other countries.
- Android is a trademark of Google LLC.
- ONVIF is trademarks or registered trademarks of Onvif Inc.
- All other trademarks identified herein are the property of their respective owners.

Important

- Safety Precautions : Carefully read the Basic Information, Installation Guide and Operating Instructions before using this product.
- Panasonic i-PRO Sensing Solutions Co., Ltd. cannot be held responsible for the performance of the network and/or other manufacturers' products used on the network.

• Masses and dimensions are approximate. • Specifications are subject to change without notice.

Panasonic®

Panasonic Corporation

Panasonic i-PRO Sensing Solutions Co., Ltd.

<https://ipro.panasonic.com>

<https://security.panasonic.com>

<https://www.linkedin.com/company/i-pro-sensing-solutions-co-ltd/>

(2A-294A)