

Preliminary

4 x 4K(33MP) Multi-Sensor Network Camera

Panasonic WV-X8571N captures the highest quality images in even very challenging and dynamic environments.

In particular, the camera can capture clear vehicle image in color even at night intersections of low light intensity.

And the four repositionable lenses minimize blind spots and flexibly correspond to intersections of various shapes and monitoring areas of cities. Easily set up with a smartphone or tablet device via Wi-Fi connection. *Wi-Fi USB adapter is required.

Intelligent Auto (iA) monitors scene dynamics and motion to adjust key camera settings automatically in real-time reducing distortion such as motion blur on moving objects. By adopting H.265 Smart Coding technology, bandwidth efficiency is intelligently increased for longer recording and less storage. Cameras out-of-the-box, use an encryption module standardized by FIPS Publication 140-2 for secure video streaming.

Extreme image quality for evidence capturing under challenging conditions

- Four repositionable lenses with easy adjustment include a wide range tilt angle mechanism minimizes blind spots
- Four high image quality 4K image sensors and produce a resolution of 3,840 x 2,160 pixels at up to 15 fps
- Sharp and clear images of fast moving vehicles with Intelligent Auto and ClearSight Coating
- Outstanding low light performance in true color with low noise for night time applications
- Super Dynamic 120dB for backlit situations and shadows on night streets
- Environmental durability : IP66, IK10 and Dehumidification device

Extreme bandwidth compression with new Panasonic H.265 Smart Coding

- Reduced the amount of transferred data and less storage space compared to any H.264 based compression techniques
- New self-learning ROI* encoding (Auto VIQS) dynamically detect motion areas to keep vehicles and human in good picture quality while lowering your bandwidth *Region of Interest

Extreme Data Security

- Full encryption SD card edge recording to keep your data safe
- FIPS140-2 CAVP compliant *Using encryption module standardized by FIPS publication 140-2
- Full end-to-end system encryption with supported VMS and devices to protect from IP snooping/spoofing and detect data alteration

Easy installation

- Continuous view assistance: After determining the monitor angle, set the lens to the specified position and the cameras will automatically zoom and focus to reduce the overlap of images from each camera.
- Installation time can be reduced by confirming live image and adjusting viewing angle with smartphone or tablet device via Wi-Fi connection.
- Allows you to connect the network cable to the camera body simply by opening a part of the package, which saves you time and workspace, especially when handling multiple cameras.

Key Features

- 4 x 4K(33MP) 3840x2160 up to 15fps
- iA (intelligent Auto)
- Color night vision (0.003 to 0.05 lx)
- H.265 Smart Coding
- Continuous view assistance
- Wide range tilt angle adjustment mechanism
- Fiber Optic Media Converter Unit (Optional WV-S25F1)
- Super Dynamic 120dB
- ClearSight Coating

Industry examples

- Public safety (City / Highway toll / Parking gate)
- Transportation (Airport / Train / Subway)



*The actual product may differ.

PRO

4 x True 4K high resolution

4K
ULTRA HD

TRUE 4K

- Can identify vehicles 100 feet diagonal from intersection corners at three lane streets

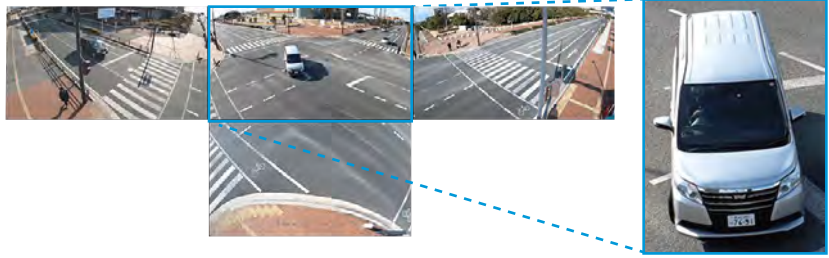

Combining H.265 compression with Smart Coding technology

- In spite of the high resolution of 4 x 4 K, it achieved the bit rate lower than the bit rate of one 4K camera of H.264.

Resolution

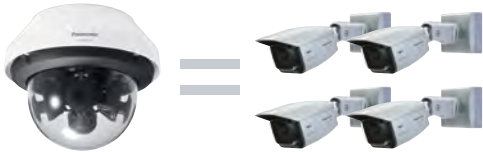

WV-X8571N

WV-SPV781L

Bit rate*



WV-X8571N

WV-SPV781L

* "H.265 with Smart Coding" provides max.95% reduction in total file size when compared to "H.264 without Smart Coding" but it depends on a scene.

Wide range tilt angle adjustment mechanism

Camera 1, 2, 3

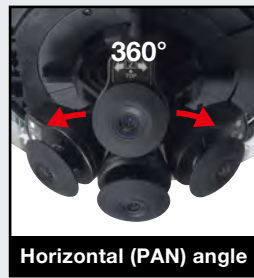
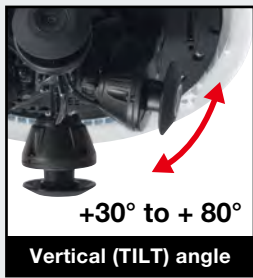

Camera 4

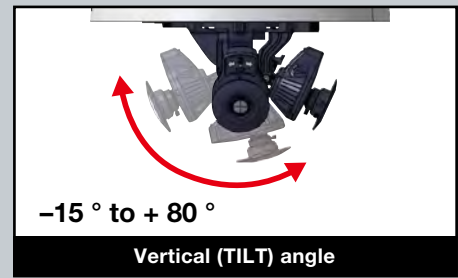

*The above is the adjustable range of a single camera. The adjustable range of each camera varies according to the positional relationship with other cameras.

Four repositionable lenses enables to monitoring at minimize blind spots

270-degree view (Full intersection view)

- One multi sensor camera at intersection corner, It enables monitoring with minimized blind spots
- Enables to monitoring even if bottom view angle

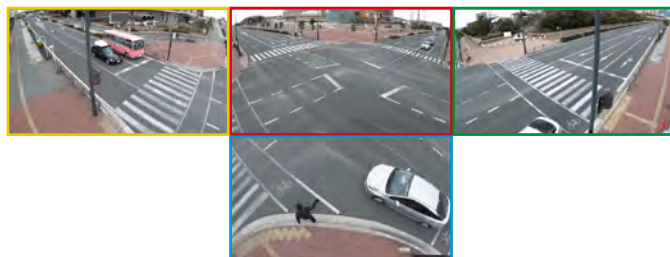
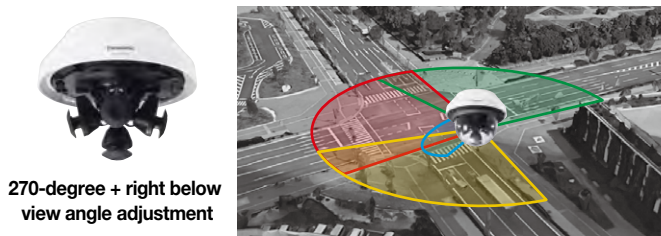

360-degree view

- One multi-sensor camera enables monitor the park by minimize blind spots

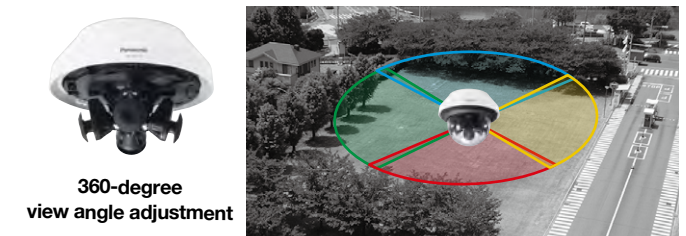

Specifications

Camera	Image Sensor	1/1.8 type CMOS image sensor
	Minimum Illumination	Color : 0.05 lx, BW : 0.03 lx (F1.6, Maximum shutter : Off (1/30s), AGC : 11) Color : 0.003 lx, BW : 0.002 lx (F1.6, Maximum shutter : max. 16/30s, AGC : 11) *1
	Intelligent Auto	On / Off
	Maximum shutter	15 fps mode: Max. 1/10000s to Max. 16/30s 12.5 fps mode: Max. 1/10000s to Max. 16/25s
	Super Dynamic	On / Off, The level can be set in the range of 0 to 31.
	Dynamic Range	Max. 120 dB typ. (Super Dynamic : On, level : 31)
	Image Settings	Gain (AGC), White balance
	Image Compensation	Adaptive black stretch, Back light compensation (BLC), High light compensation (HLC), Fog compensation, Digital noise reduction
	Color/BW (ICR)	Off / On / Auto1 (Normal) / Auto2 (IR Light) / Auto3 (SCC)
	Video Motion Detection (VMD)	On / Off, 4 areas available
	Privacy Zone	On / Off, up to 8 zones available
	Upside-down	On / Off
	Camera Title (OSD)	On / Off, Up to 20 characters (alphanumeric characters, marks)
	Adjusting angle	Camera 1, 2, 3: Horizontal (PAN) angle : 360 ° Vertical (TILT) angle : +30 ° to + 80 ° Azimuth (YAW) angle : ±50 ° Camera 4: Horizontal (PAN) angle : 360 ° Vertical (TILT) angle : -15 ° to + 80 ° Azimuth (YAW) angle : ±50 ° *The above is the adjustable range of a single camera. The adjustable range of each camera varies according to the positional relationship with other cameras.
	Lens	Zoom Ratio
Digital (electronic) zoom		Choose from 3 levels of x1, x2, x4
Focal length		4.6 mm (3/16 inches)
Maximum Aperture Ratio		1 : 1.6
Focus range		3.0 m (9.84 feet) – ∞
Angular Field of view		Horizontal : 97° Vertical : 53°
Browser GUI		Camera Control
	Audio	Mic (Line) Input : On / Off Volume adjustment : Low / Middle / High
	GUI / Setup Menu Language	English, Italian, French, German, Spanish, Portuguese, Russian, Chinese, Japanese
	Network	Network IF
Resolution		[16:9 mode] *Cannot be changed. 3840 x 2160 / 2560 x 1440 / 1280 x 720 / 640 x 360 / 320 x 180
H.265/ Transmission Mode		Constant bit rate / VBR / Frame rate / Best effort
H.264*2 Transmission Type		Unicast port(AUTO) / Unicast port(MANUAL) / Multicast
JPEG Image Quality		10 steps
Smart Coding		GOP (Group of pictures) control : On (Frame rate control) * / On (Advanced) * / On (Mid) / On (Low) / Off * *On (Frame rate control) and On (Advanced) are only available with H.265. Auto VIOS : On / Off
Audio Compression		G.726 (ADPCM) : 16 kbps / 32 kbps G.711 : 64 kbps AAC-LC*3 : 64 kbps / 96 kbps / 128 kbps

Network	Supported Protocol	IPv6 : TCP/IP, UDP/IP, HTTP, HTTPS, SMTP, DNS, NTP, SNMP, DHCPv6, RTP, MLD, ICMP, ARP, IEEE 802.1X, DiffServ IPv4 : TCP/IP, UDP/IP, HTTP, HTTPS, RTSP, RTP, RTP/RTCP, SMTP, DHCP, DNS, DDNS, NTP, SNMP, UPnP, IGMP, ICMP, ARP, IEEE 802.1X, DiffServ
	Maximum concurrent access number	Up to 24 users (Depends on network conditions)
	SDXC/SDHC/SD Memory Card	H.265 / H.264 recording : Manual REC / Alarm REC (Pre/Post) / Schedule REC Compatible SDXC/SDHC/SD card : Panasonic 2 GB, 4 GB*, 8 GB*, 16 GB*, 32 GB*, 64 GB**, 128 GB**, 256 GB** model *SDHC card, ** SDXC card (except miniSD card and microSD card)
	Mobile Terminal Compatibility	iPad / iPhone, Android™ terminals
Alarm	Alarm Source	3 terminals input, VMD alarm, Command alarm
	Alarm Actions	SDXC/SDHC/SD memory recording, E-mail notification, HTTP alarm notification, Indication on browser, Panasonic alarm protocol output
Input/ Output	Audio Input	ø3.5 mm stereo mini jack (Audio input is stereo)
	For microphone input	Recommended applicable microphone: Plug-in power type (Sensitivity of microphone : -48 dB±3 dB (0 dB=1 V/Pa, 1 kHz)) Input impedance : Approx. 2 k (unbalanced) Supply voltage : 2.4 V ±0.5 V Input level : Approx. -10 dBV
	For line input	Input level : Approx. -10 dBV
	External I/O Terminals	ALARM IN 1(Alarm input 1/ Black & white input/ Auto time adjustment input) (x1), ALARM IN 2 (Alarm input 2/ ALARM OUT) (x1), ALARM IN 3 (Alarm input 3/ ALARM OUT/ AUX OUT) (x1)
General	Safety	UL (UL60950-1), c-UL (CSA C22.2 No.60950-1), CE, IEC60950-1
	EMC	FCC (Part15 ClassA), ICES003 ClassA, EN55032 ClassB, EN55024
	Power Source and Power Consumption	PoE+ (IEEE802.3at compliant): DC 54V 350 mA, Approx. 20 W(Class4 device) DC12 V 1.2 A, Approx. 15 W
	Ambient Operating Temperature	-40 °C to +60 °C (-40 °F to +140 °F)
	Ambient Operating Humidity	{Power On range : -20 °C to +60 °C (-4 °F to +140 °F)} 10 to 100 % (no condensation)
	Dehumidification Device	Rosahl element
	Water and Dust Resistance	IP66 (IEC60529), Type 4X (UL50), NEMA 4X compliant
	Shock Resistance	IK10 (IEC62262)
	Wind Resistance	Up to 40 m/s (approx. 89 mph)
	Dimensions	When using the attachment plate only : ø230 mm x 196 mm (H) {ø9-1/16 inches x 7-23/32 inches (H)}, Dome radius 80 mm {3-5/32 inches}
Mass (approx.)	When using the attachment plate only : Approx. 2.8 kg (6.17 lbs)	
Finish	Main body : Aluminum die cast, i-PRO white, Outer fixing screws : Stainless steel (Corrosion-resistant treatment) Dome cover : Polycarbonate resin (with ClearSight coating), Clear	

*1 Converted value

*2 H.265/H.264 can be selected for each stream.

*3 When recording audio on an SD memory card, only use AAC-LC (Advanced Audio Coding-Low Complexity).

Appearance

Unit : mm (inches)

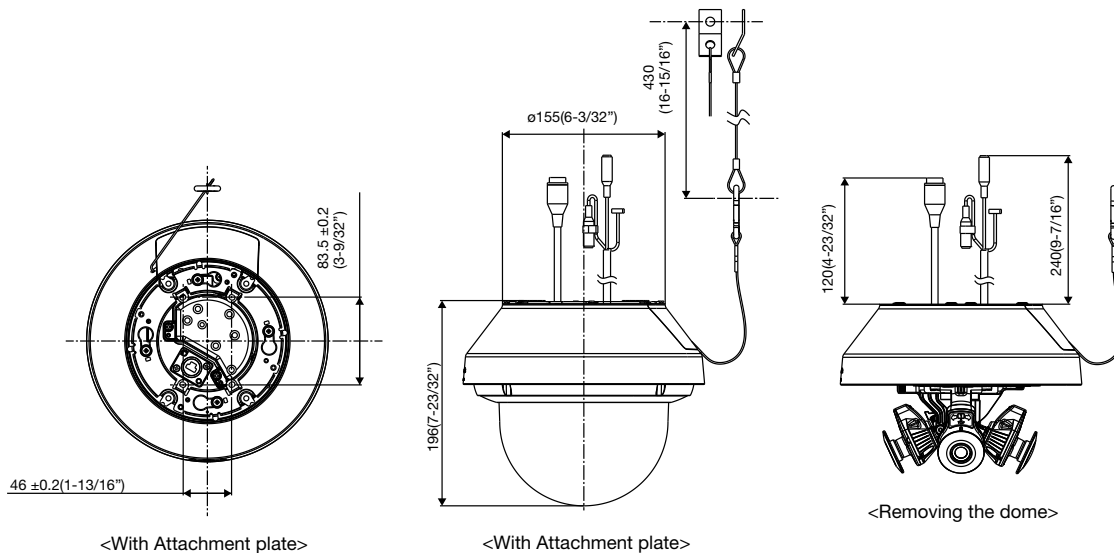

Optional Accessories

Fiber Optic Media Converter Unit

Extension Unit
WV-S25F1
(Light gray)



Fiber Optic Media Converter Unit supports long distance optical networks by converting copper RJ45 to fiber.

• Basic specifications

Power source	24 V AC(50 Hz/60 Hz)
Ambient Operating Temperature :	-40 °C to +60 °C(-40 °F to 140 °F) (Power On range: -30 to +60 (-22 °F to 140 °F))
Ambient Operating Humidity :	10 % to 100 % (no condensation)
Waterproof	IP66(IEC60529)
Shock resistance	IK10(IEC62262)

*Refer to website for compatible SFP modules. <https://security.panasonic.com/support/info/> <Control No. : C0504>

• Support specifications for SFP module

SFP Port Type	LC type
Ethernet Speed	100/1000 Mbps
Supply voltage, current	3.3 V typical, Max. 300 mA
SFP Cage	Standard mini-SFP cage (For 6.5 mm pitch SFP)

*Different Color Model WV-X65F1 (Fine silver)

Mount Bracket / Other

<p>Ceiling Mount Bracket WV-Q105A</p> <p>*For indoor installation only</p>	<p>Base Bracket WV-QJB501-W (i-PRO white)</p>	<p>Mount Bracket WV-QSR502A-W (i-PRO white)</p> <p>(This bracket requires WV-QCL501-W, WV-QWL501-W or WV-QAT500-W.)</p>	<p>Ceiling Mount Bracket WV-QCL501-W (i-PRO white)</p> <p>(This bracket requires WV-QSR502A-W.)</p>	<p>Wall Mount Bracket WV-QWL501-W (i-PRO white)</p> <p>(This bracket requires WV-QSR502A-W.)</p>	<p>Pole Mount Bracket WV-QPL500-W (i-PRO white)</p> <p>(This bracket requires WV-QWL501-W.)</p>
<p>Corner Mount Bracket WV-QCN500-W (i-PRO white)</p> <p>(This bracket requires WV-QWL501-W.)</p>	<p>Attachment pipe (For 3rd party bracket) WV-QAT500-W (i-PRO white)</p> <p>(This bracket requires WV-QSR502A-W.)</p>				

• Brackets are available in four colors, Fine silver, Light gray, Gray and i-PRO white. It is possible to use them in different color combinations.

Important

- Safety Precautions : Carefully read the Basic Information, Installation Guide and Operating Instructions before using this product.
- Panasonic cannot be held responsible for the performance of the network and/or other manufacturers' products used on the network.

Trademarks and registered trademarks

- iPad and iPhone are trademarks of Apple Inc., registered in the U.S. and other countries.
- Android is a trademark of Google LLC.
- All other trademarks identified herein are the property of their respective owners.
- Masses and dimensions are approximate. • Specifications are subject to change without notice.

Panasonic®

Panasonic Corporation

Panasonic i-PRO Sensing Solutions Co., Ltd.

<https://ipro.panasonic.com>

<https://security.panasonic.com>

<https://www.linkedin.com/company/i-pro-sensing-solutions-co-ltd/>

(2A-273A)