

EXSITE® IR PTZ ENHANCED 2 SERIES

2 MP

SEE IN TOTAL DARKNESS OR BLINDING LIGHT WITHIN HAZARDOUS ENVIRONMENTS

The ExSite® IR PTZ Enhanced 2 Series is an explosion-proof, Day/Night Pan-Tilt-Zoom (PTZ) camera with built-in IR illumination. This dual-headed video security camera offers up to 30x zoom and full 1080p resolution. The IR illuminator provides clear object detection up to 200m away, even in total darkness and at different zoom levels. Designed with AISI 316L stainless steel and micro-shot, electro-polished surfaces, it offers maximum resistance in corrosive environments, such as industrial and marine locations. In addition, the ExSite IR PTZ offers up to IP69, NEMA Type 4X and Type 6P ratings, ensuring protection against extreme conditions, including water and dust. With the Small Form-Factor Pluggable (SFP) slot built into the junction box, this PTZ camera provides easy installation through fiber optic connections.



FEATURES



SMART ANALYTICS POWERED BY MOTOROLA SOLUTIONS

Detects and classifies more objects for greater accuracy and faster responses, even in crowded scenes.¹



HAZARDOUS LOCATION CERTIFICATIONS

Heavy-duty housing meets stringent explosion-proof and dust ignition-proof requirements while complying with international standards (UL, CSA, ATEX, IECEx, EACEx, KCs, UKEx, INMETRO).



HIGH-TEMPERATURE RANGE

Optimized to operate reliably even at increased temperature variances: from -40°C (-40°F) up to +70°C (+158°F).



VARIFOCAL IR ILLUMINATION

Integrate automated IR varizoom, illuminating up to 200m from the camera to see events in the dark.



H.264 AND H.265 WITH SMART COMPRESSION TECHNOLOGY

Optimizes compression levels for regions in a scene to help maximize bandwidth savings and keep storage costs down.



ONVIF® COMPLIANT

ONVIF Profile S, G and T compliance allows for easy integration with existing ONVIF infrastructures. Integrates with Pelco VideoXpert and other leading video management systems.



WIDE DYNAMIC RANGE

Captures high-quality image details in scenes with dark and light backgrounds.



PEACE OF MIND

We back this camera with a 3-year industry-leading warranty.

ONVIF is a trademark of Onvif, Inc.

¹ Analytic capabilities are based on home position only.

For more information, contact your local Pelco sales representative today at pelco.com/about/contact-us/#form.

SPECIFICATIONS

IMAGE PERFORMANCE		2.0 MP
Image Sensor		1/3" progressive scan CMOS
Active Pixels (H x V)		1944 (H) x 1212 (V)
Imaging Area (H x V)		5.568 mm (H) x 3.132 mm (V); 0.219 " (H) x 0.123 " (V)
IR Illumination Max Distance*	Dual head: 13° and 40°16°	200m
IR Min Illumination		0.03 lux (F/1.6) in color mode; 0.02 lux F/1.6) in monochrome
Max LEDs	Number	11
	Wavelength	850nm
LED Configuration*	Wide beam angle of illumination	40° (horizontal), 16° (vertical)
	Spot beam angle of illumination	13° (horizontal), 13° (vertical)
Dynamic Range		Up to 120 dB
Image Rate		Up to 60 fps
Aspect Ratio (Resolution Scaling)		Down to (16:9) 384x216 or (5:4) 320x256
3D Noise Reduction Filter		Yes

* The distances and the performance depend on the environmental conditions. Illumination activation by software can be activated via presets or the zoom factor, based on the scene brightness, from alarm input or manually.

LENS		2.0 MP
Lens		F1.6, 4.3-129 mm (30x zoom) remote focus and zoom
Angle of View	Horizontal	(16:9) 2.34° - 65.1°
	Vertical	(16:9) 1.36° - 38.4°
Zoom		Up to 30x

IMAGE CONTROL	
Video Compression	H.264 and H.265 Pelco Smart Compression, Motion JPEG
Streaming	Multi-stream H.264, Multi-stream H.265, Motion JPEG
Motion Detection	Pixel motion: Selectable sensitivity and threshold. Classified object detection
Electronic Shutter Control	Automatic, Manual (1/1 to 1/30,000 sec)
Iris Control	Automatic, Open, Closed
Day/Night Control	Automatic, Color, Monochrome, External
Flicker Control	60 Hz, 50 Hz
White Balance	Automatic, Manual
Backlight Compensation	On/Off
Privacy Zones	3D, up to 64 zones
Presets	500 named presets
Tours	10 named tours
Electronic Image Stabilization	Yes
Digital Defog	Adjustable/Off

NETWORK	
Network	10BASE-T/100BASE-T (RJ45) and 100BASE-FX (SFP)
Ports	RJ45 connector (CAT5E cabling) and SFP slot
ONVIF	ONVIF compliance Profile S, Profile T, and Profile G (www.onvif.org)
Security	Password protection, HTTPS encryption, digest authentication, WS authentication, user access log, 802.1x port based authentication
Protocols	IPv6, IPv4, HTTP, HTTPS, SOAP, DNS, NTP, RTSP, RTCP, RTP, TCP, UDP, IGMPv2, ICMP, DHCP, Zeroconf, ARP, HSTS
Streaming Protocols	RTP/UDP, RTP/UDP multicast, RTP/RTSP/TCP, RTP/RTSP/HTTP/TCP, RTP/RTSP/HTTPS/TCP, HTTP
Device Management Protocols	SNMP v2c, SNMP v3

MECHANICAL	
Dimensions (LxWxH)	453 mm x 232 mm x 398 mm; 17.83" x 9.13" x 15.7"
Weight	35 kg; 77 lbs
Construction	AISI 316L stainless steel
Finish	Electro-polished surface
Pan Movement	360° continuous
Vertical Tilt	-90° to 90°
Maximum Pan/Tilt Speed	100°/s
Wiper	Yes
Cable Entry	2 x 3/4" NPT

ELECTRICAL	
Local Storage	Optional factory installed 128GB, Micro SDXC Card.
Ports	10BASE-T/100BASE-T, RJ45 connector (CAT5E cabling) and SFP slot
Power Consumption	120 W max.
Input Voltage (Power)	Ordering options: From 220 VAC up to 230 VAC ±10%, 0.54 A, 50/60 Hz 24 VAC ±10%, 5A, 50/60 Hz 120 VAC ±10%, 1A, 50/60 Hz
Input for Remote Reset	1
Alarm Inputs	1
Relay Outputs	1+1 (one relay reserved for washer pump and one configurable, 1A, 30 VAC/60 VDC max)
Audio Input and Output	None





ENVIRONMENTAL	
Operating Temperature	-40 °C to +55 °C (-40 °F to 131 °F) in enclosed space, -40 °C to +60 °C (-40 °F to 140 °F) with ambient convection
Storage Temperature	-40 °C to +55 °C (-40 °F to 131 °F)
Humidity	5% - 95% non-condensing
Cold Start	Up to 2 hour startup delay at temperature lower than -10 °C (14 °F)
Wind Resistance	Pan and tilt operational at a maximum of 210 km/h wind (130.5 mph)

CERTIFICATIONS	
Certifications/Directives	cULus, CE, UKCA, ROHS, RCM
Safety	UL 62368-1, CSA 62368-1, IEC/EN 62368-1, IEC/EN 62471
Hazardous	ATEX (EN IEC 60079-0, EN 60079-1, EN 60079-31), IECEx (IEC 60079-0, IEC 60079-1, IEC 60079-31), UL listed for USA (UL 60079-0, UL 60079-1, UL 60079-31), UL listed for Canada (CAN/CSA-C22.2 NO. 60079-0, CAN/CSA-C22.2 NO. 60079-1, CAN/CSA-C22.2 NO. 60079-31), EAC Ex (TR CU 012/2011), INMETRO (ABNT NBR IEC 60079-0, ABNT NBR IEC 60079-1, ABNT NBR IEC 60079-31), KCs (Employment and labor department 2021-22), UK Ex (EN IEC 60079-0, EN 60079-1, EN 60079-31)

CERTIFICATIONS

Environmental and Performance	UL/CSA/IEC 60950-22, IEC 62262 IK10 Impact Rating (enclosure only), IEC 60529 IP69 Weather Rating, IEC 60068-2-1, IEC 60068-2-2, IEC 60068-2-6, IEC 60068-2-30, IEC 60068-2-52 NEMA TS 2 para 2.2.7 - 2.2.9, Type 4X and 6P
Electromagnetic Emissions	FCC Part 15 Subpart B Class A, IC ICES-003 Class A, EN 55032 Class A, EN 61000-6-4, EN 61000-3-2, EN 61000-3-3
Electromagnetic Immunity	EN 50130-4
Vibration Test	EN 50130-5, EN 60068-2-6
Marine Certification	Lloyd's Register* *At the time of this publication, certifications are pending. Consult the factory or www.pelco.com for the current status of certifications.
Warranty	3-year limited warranty. 5-year extended warranty is available.

EXPLOSION-PROOF CERTIFICATIONS

PART NUMBER	CERTIFICATION	MARKING	AMBIENT TEMPERATURE	CABLE ENTRY TEMPERATURE
EXPE2-2X30-SPT-IRM2F EXPE2-2X30-SPT-IRM2FG EXPE2-2X30-SPT-IRACF EXPE2-2X30-SPT-IRACFG EXPE2-2X30-SPT-IRM1F EXPE2-2X30-SPT-IRM1FG	DEMKO 12 ATEX 1031198X	 II 2G Ex db IIC T6...T4 Gb  II 2D Ex tb IIIC T85°C...T135°C Db	-40°C ≤ Ta ≤ +50°C or +60°C or +70°C (T6/T85°C with Ta ≤ +50°C) (T5/T100°C with Ta ≤ +60°C) (T4/T135°C with Ta ≤ +70°C)	+80°C with Ta ≤ +60°C +90°C with Ta ≤ +70°C
	IECEX ULD 11.0005X	Ex db IIC T6...T4 Gb Ex tb IIIC T85°C...T135°C Db		
	EAC Ex RU C -IT.H A91.B .00274/22	1Ex db IIC T6...T4 Gb X Ex tb IIIC T85°C...T135°C Db X		
	INMETRO UL-BR 13.0063X	Ex db IIC T6...T4 Gb Ex tb IIIC T85°C...T135°C Db		
	KCs 21-KA4B0-0520X, 21-KA4B0-0521X	Ex db IIC T6...T4 Gb Ex tb IIIC T85°C...T135°C Db		
	UKEx UL21UKEX2216X	 II 2G Ex db IIC T6...T4 Gb  II 2D Ex tb IIIC T85°C...T135°C Db		
	cULus File E319666 Hazardous Location America	Class I, Zone 1, AEx db IIC T5...T4 Gb Zone 21, AEx tb IIIC T100°C...T135°C Db Class I, Div 2, Group A, B, C, D T5...T4 Class II, Div 2, Group F, G T5...T4		
cULus File E319666 Hazardous Location Canada	Ex db IIC T5...T4 Gb X Ex tb IIIC T100°C...T135°C Db X Class I, Div 2, Group A, B, C, D T5...T4 Class II, Div 2, Group F, G T5...T4			

ANALYTICS SPECIFICATIONS

SUPPORTED ANALYTICS EVENTS*	
Objects in Area	The event is triggered when the selected object type moves into the region of interest.
Object Loitering	The event is triggered when the selected object type moves into the region of interest, then stays for an extended amount of time.
Objects Crossing Beam	The event is triggered when the specified number of objects have crossed the directional beam that is configured over the camera's field of view. The beam can be unidirectional or bidirectional.
Object Appears or Enters Area	The event is triggered by each object that enters the region of interest and can also be used to count objects.
Object Not Present in Area	The event is triggered when no objects are present in the region of interest.
Objects Enter Area	The event is triggered when the specified number of objects have entered the region of interest.
Objects Leave Area	The event is triggered when the specified number of objects have left the region of interest.
Object Stops in Area	The event is triggered when an object moves into a region of interest and then stops moving for the specified threshold time.
Direction Violated	The event is triggered when an object moves in the prohibited direction of travel.
Sabotage Detection	The event is triggered when the scene unexpectedly changes.

*Pelco Smart Analytics powered by Motorola Solutions.

AUTO-TRACK OBJECTS IN AREA	
Auto-track Objects in Area	The event is triggered when the selected object type moves into the region of interest defined at the home position. The camera will automatically reposition to track the object, returning to the preset home position once object is lost.

SYSTEM MODEL NUMBERS

SYSTEM RESOLUTION	MODEL #	DESCRIPTION
2 MP 30X	EXPE2-2X30-SPT-IRM2F	EXPE2 2MP 30X SS IR PTZ, 230VAC ExSite Enhanced Series 2, 2MP 30x Zoom, Stainless Steel PTZ with IR illuminator 850nm, SPOT and WIDE lenses Mains 220-230Vac
2 MP 30X	EXPE2-2X30-SPT-IRACF	EXPE2 2MP 30X SS IR PTZ, 24VAC ExSite Enhanced Series 2, 2MP 30x Zoom, Stainless Steel PTZ with IR illuminator 850nm, SPOT and WIDE lenses 24Vac
2 MP 30X	EXPE2-2X30-SPT-IRM1F	EXPE2 2MP 30X SS IR PTZ, 120VAC ExSite Enhanced Series 2, 2MP 30x Zoom, Stainless Steel PTZ with IR illuminator 850nm, SPOT and WIDE lenses Mains 120Vac
2 MP 30X	EXPE2-2X30-SPT-IRM2FG	EXPE2 2MP 30X SS IR PTZ, 230VAC SD ExSite Enhanced Series 2, 2MP 30x Zoom, Stainless Steel PTZ with IR illuminator 850nm, SPOT and WIDE lenses Mains 220-230Vac, with preinstalled SD for ONVIF G
2 MP 30X	EXPE2-2X30-SPT-IRACFG	EXPE2 2MP 30X SS IR PTZ, 24VAC SD ExSite Enhanced Series 2, 2MP 30x Zoom, Stainless Steel PTZ with IR illuminator 850nm, SPOT and WIDE lenses Mains with preinstalled SD for ONVIF G
2 MP 30X	EXPE2-2X30-SPT-IRM1FG	EXPE2 2MP 30X SS IR PTZ, 120VAC SD ExSite Enhanced Series 2, 2MP 30x Zoom, Stainless Steel PTZ with IR illuminator 850nm, SPOT and WIDE lenses Mains with preinstalled SD for ONVIF G

MOUNTING ACCESSORIES

PART #	DESCRIPTION
MPXCW	Corner mount adapter for use with ExSite cameras. Max load 50 kg (110 lb.). AISI 316L stainless steel.
MPXWBA	AISI 316L stainless steel wall bracket.
MPXCOL	Pole mount adapter for use with ExSite cameras. For pole diameters from 110 mm (4.3") to 150 mm (5.9"). Max load 50 kg (110 lb.). AISI 316L stainless steel.
MPXWBTA	AISI 316L stainless steel parapet or ceiling mounting bracket.

CABLING

ITEM	DESCRIPTION
MPX2CABL41	Cabling, 4m (13.1 ft), unarmored cable, barrier cable gland
MPX2CABL101	Cabling, 10m (32.8 ft), unarmored cable, barrier cable gland
MPX2CABLARM41	Cabling, 4m (13.1 ft), armored cable, barrier cable gland
MPX2CABLARM101	Cabling, 10m (32.8 ft), armored cable, barrier cable gland

CABLE GLANDS AND ACCESSORIES 3/4" NPT

TYPE	CERTIFICATION	OPERATING TEMP.	CABLE	PART NUMBER	MAXIMUM DIAMETER OF THE EXTERNAL SHEATH (A)	MAXIMUM DIAMETER OF THE INTERNAL SHEATH (B)	MAXIMUM DIAMETER OF THE CONDUCTORS BUNDLE (C)
Barrier Cable Gland	IECEX / ATEX / EAC Ex	-60°C (-76°F) / +135°C (+275°F)	Unarmored	OCTEXB3/4P	20.0 mm (0.78 in)	-	17.8 mm (0.7in)
			Armored	OCTEXBA3/4P	16.8 - 23.9 mm (0.66-0.94 in)	20 mm (0.79 in) max	17.8 mm (0.7 in)
Cable Gland with Gasket	IECEX / ATEX / EAC Ex	-60°C (-76°F) / +100°C (+212°F)	Unarmoured	OCTEX3/4C	13.0 - 20.2 mm (0.51-0.79 in)	-	-
			Armored	OCTEXA3/4C	16.9 - 26.0 mm (0.66-1.02 in)	11.1 - 19.7 mm (0.44 - 0.78 in)	-
	ATEX	-40°C (-40°F) / +100°C (+212°F)	Unarmoured	OCTEX3/4	14.0 - 17.0 mm (0.55-0.67 in)	-	-
			Armoured	OCTEXA3/4	18.0 - 23.0 mm (0.71-0.91 in)	14.0 - 17.0 mm (0.55-0.67 in)	-
Plug EX 3/4"NPT	IECEX / ATEX / EAC Ex	-100°C (-148°F) / +400°C (+752°F)	-	OEXPLUG3/4P	-	-	-
Conduit Sealing Fitting	IECEX / ATEX / cCSAus / EAC Ex	-60°C (-76°F) / +80°C (+176°F)	-	OCTEXP3/4C	-	-	11.0 mm (0.43 in)
Reduction 3/4" NPT x 1/2" NPT	IECEX / ATEX / EAC Ex	-100°C (-148°F) / +400°C (+752°F)	-	OCTEX1/2-3/4P	-	-	-

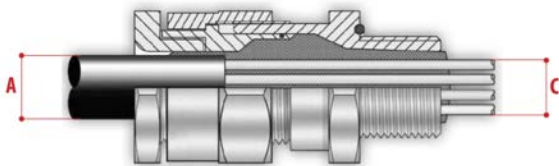

Barrier cable gland with unarmoured cable

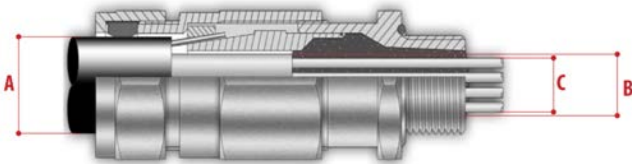

Barrier cable gland with armoured cable

TYPE	CERTIFICATION	OPERATING TEMP.	CABLE	PART NUMBER	MAXIMUM DIAMETER OF THE EXTERNAL SHEATH (A)	MAXIMUM DIAMETER OF THE INTERNAL SHEATH (B)	MAXIMUM DIAMETER OF THE CONDUCTORS BUNDLE (C)
------	---------------	-----------------	-------	-------------	---	---	---

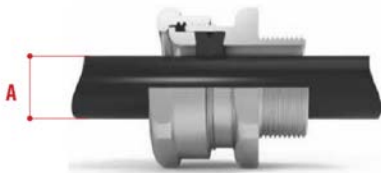

Cable gland with gasket with unarmoured cable



Cable gland with gasket with armoured cable

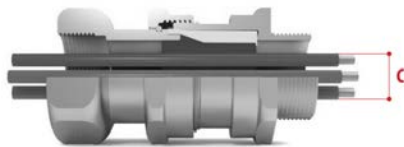

Conduit sealing fitting

EXPLOSION-PROOF COMMUNICATION BOX

A communication box includes a 3-port RJ45 and 1 SFP port Ethernet switch and 24 VAC output for powering up to one of the following:

- 2x EXC2602 fixed compact cameras
- 2x EXF2230 fixed cameras with 2x washer pump
- 1x EXP2230 PTZ camera with 1x washer pump

PART #	DESCRIPTION
MBA1S5A	Aluminum housing, 230 VAC input.
MBA2S5A	Aluminum housing, 24 VAC input.
MBA3S5A	Aluminum housing, 120 VAC input.
MBX1MAA	AISI 316L stainless steel housing, 230 VAC input.
MBX2MAA	AISI 316L stainless steel housing, 24 VAC input.
MBX3MAA	AISI 316L stainless steel housing, 120 VAC input.
MBXMP	Adapter plate for communication box to MPXCOL or MPXCW mounts. AISI 316L stainless steel housing.
MBXWRE	Wrench for opening communication boxes, MBX.
MPXCOL	Pole mount adapter for use with ExSite cameras. For pole diameters from 110 mm (4.3") to 150 mm (5.9"). Max load 50 kg (110 lb.). AISI 316L stainless steel.
MPXCW	Corner mount adapter for use with ExSite cameras. Max load 50 kg (110 lb.). AISI 316L stainless steel.

EXPLOSION-PROOF WASHER

A 10L (2.6 gal) tank with integrated manual pump and delivery up to 20m (66 ft), 24 VAC/VDC input.

PART #	DESCRIPTION
WASEX2T4AT WASEX2T4IC WASEX2T4IN WASEX2T4KC WASEX2T4GOR WASEX2T4UL	ATEX certified solenoid valve. IECEX certified solenoid valve. INMETRO certified solenoid valve. KCS certified solenoid valve (only 24 VDC). EAC Ex certified solenoid valve. cULus certified solenoid valve.
NXCOL	Pole mount adapter for use with EXF2230 cameras or explosion protected washers. For pole diameters from 110 mm (4.3") to 150 mm (5.9"). Max load 50 kg (110 lb.). AISI 316L stainless steel.
NXCW	Corner mount adapter for use with EXF2230 cameras or explosion protected washers. Max load 50 kg (110 lb.). AISI 316L stainless steel.

DIMENSIONS

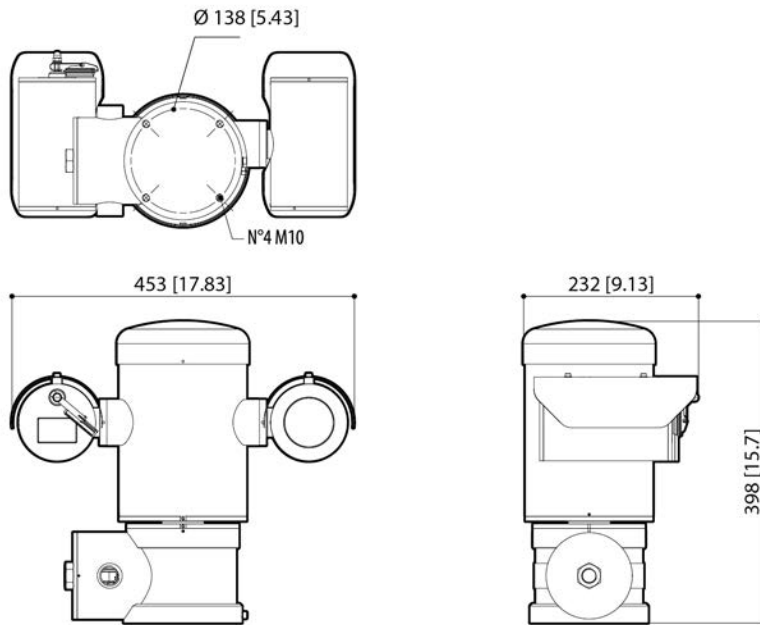

Values in parentheses are inches; all others are millimeters.

ORDERING INFORMATION

PTZ CAMERAS

	MP	WDR	SUREVISION TECHNOLOGY	ANALYTICS AT HOME POSITION	LENS	ZOOM	IP66/67/68/69	PELCO SMART COMPRESSION
EXPE2-2X30-SPT	2.0	✓	✓	✓	4.3 – 129 mm	30x	✓	✓

SUPPORT

Learn more and find additional documentation at pelco.com or email support@pelco.com for specific product support.



Jun 2023 | | Rev 1

© 2023, Motorola Solutions, Inc. All rights reserved. MOTOROLA, MOTO, MOTOROLA SOLUTIONS, and the Stylized M Logo are trademarks or registered trademarks of Motorola Trademark Holdings, LLC and are used under license. Pelco, the Pelco logo, and other trademarks associated with Pelco products referred to in this publication are trademarks of Pelco, Inc. or its affiliates. All other product names and services are the property of their respective companies. Product specifications and availability are subject to change without notice.