

Digiplex EVO

High Security and Access System

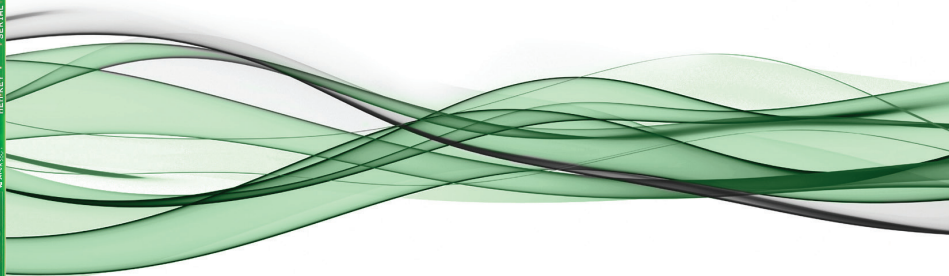
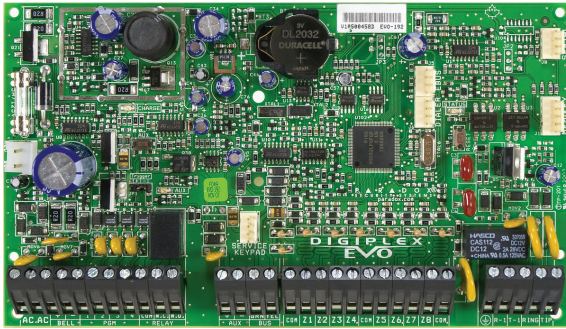

Description

Digiplex EVO systems (EVO192) provide the highest level of protection for banks, government sites, luxurious residential homes and any place where maximum security is essential. The modular concept of these systems provide installers with labour-saving features that make expanding, installing and servicing these systems quick and convenient.

Expand your system by adding expansion modules anywhere, in any combination, on the 4-wire combus. Modules are connected to the combus at the most convenient location and their zone inputs are assigned to the desired zone and partition. Keyswitches, remote controls, and unused module inputs do not use zones. Once installed, all combus modules (including motion detectors) can be programmed remotely via a keypad, or the BabyWare PC software.

Digiplex EVO integrates access control solutions. Your alarm system user database can be used to manage the access for up to 32 doors, and the monitoring of these doors can be included in any partition. By merging security and access control, Digiplex EVO systems increase the level of protection offered by security systems to a whole new level.

Feature Comparison

Feature	EVO192
Maximum Zones*	192
On-board Zones	8 (16 with ATZ)
Partitions	8
User Codes	999
Multibus	✓
Stay Arming	✓
Panel In-field Firmware Upgradable	✓
Access Control (Doors)	32
Access Levels / Schedules	16 / 32
Events Buffered	3584
PGMs	32 (5 on-board)
PGM +/- Trigger	✓
Virtual Zones**	32
Expansion Modules*	254
Supports IP / GPRS / GSM Communication (PCS Series)	✓
Supports VDMP3 Plug-in Voice Module	✓
Supports IP150 Internet Module	✓
Software	NEware, BabyWare
Listen-in Capabilities	✓

* Can be any combination of hardwire, wireless or addressable zones, or modules
 ** Automate PGM activations without occupying security zones



System Overview

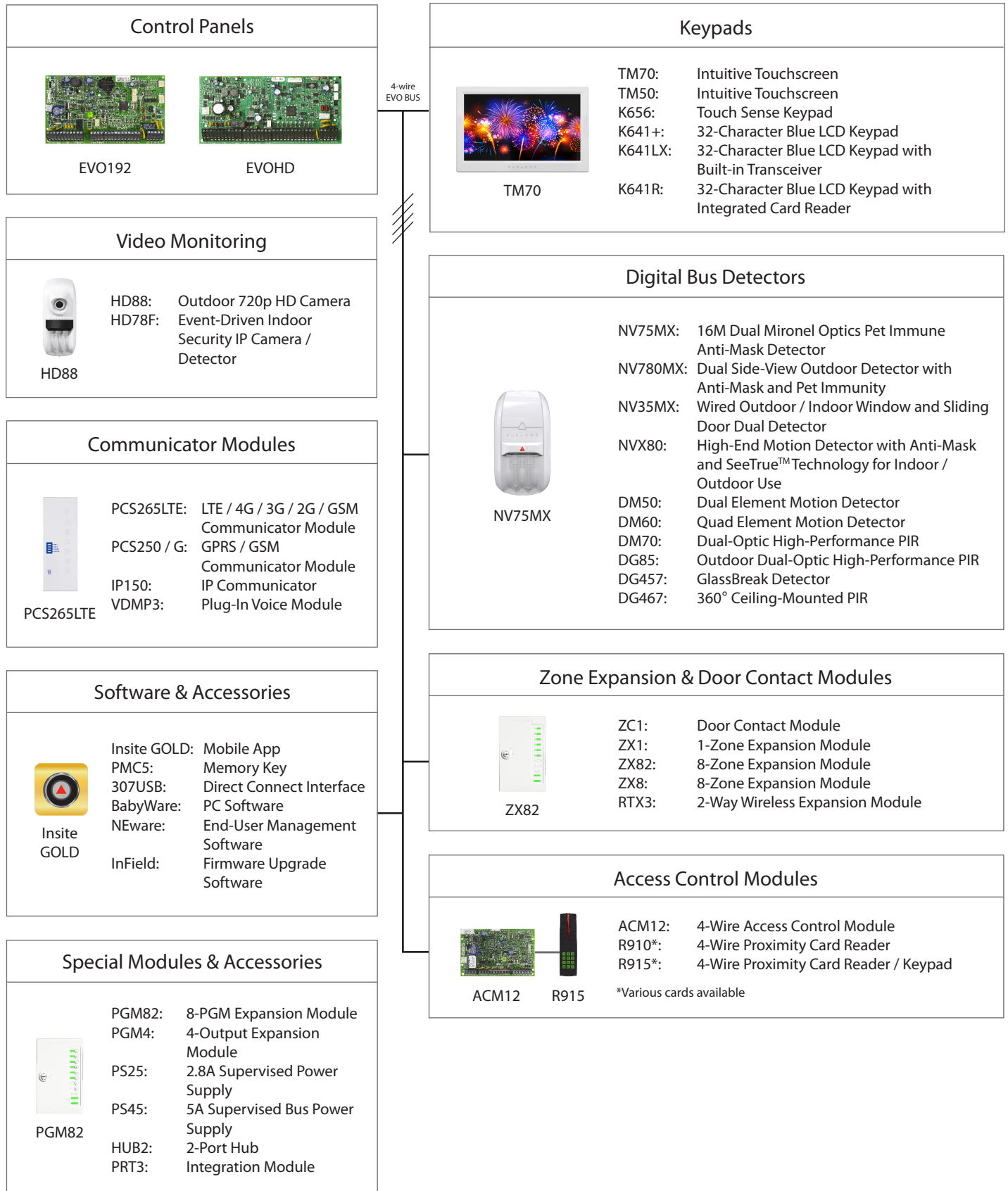

Feature Details



Internet Communication (IP150)

The IP150 Internet Module allows you to control and monitor your security system remotely through any web browser. It allows for email notifications of important system events such as alarms, arm/disarm events, and troubles. For example, receive an email at work when your kids get back from school. You can also view the live status of your system and arm/disarm it. For example, you have just left your office for the weekend but are not sure you remembered to arm the system. Simply check the status of your system from a laptop and arm it.



Wireless Communication (PCS Series)

The PCS series modules provide the Digiplex EVO control panels with wireless communication capabilities to report system events via IP, GPRS, and/or GSM. Whether it be uploading/downloading via IP or GPRS, receiving system status and events by voice or text message, or reporting to the monitoring station via IP, GPRS, or GSM, the PCS series enhances the communication capabilities of any Digiplex EVO installation.



Voice Communication (VDMP3)

The VDMP3 is a plug-in, voice-assisted module that can be programmed to call up to 5 telephone numbers in the event of an alarm. For example, when an alarm occurs at your store during off-hours, every employee can receive notification via telephone; e.g., "Area 1 in alarm. Zone 3. Press 1 to disarm the system..." You can also call the VDMP3 from an outside line, enabling you to arm or disarm the system as well as activate PGMs. The VDMP3 essentially turns any outside telephone into a keypad. The VDMP3 is easy to install; plug it in directly onto the panel, set the phone numbers, and select the activation event.



In-field Upgradable

Digiplex EVO is not only easy to install, but is also fully in-field upgradable for simple on-site updates. The process is effortless; connect the PC to the panel and you are a few clicks away from performing a complete system upgrade within minutes. No need to change panels or hardware; all the updates are done using Paradox's InField Firmware Upgrade Software.



Access Control

Access control can be added to the Digiplex EVO system to provide additional control over who has access to your premises, even when your security system is not armed and you are not there to supervise. With added access control you can limit access to certain areas, disallow access to others, or control entire groups of people according to their schedule or privileges. Make your premises inadmissible to all except those with access cards, track anybody who enters your premises, print detailed reports of access control activities, and more.



App-based System Control

The Insite GOLD app enables you to remotely access your Paradox security system and view your system cameras. Insite GOLD provides lots of functionality and information at one's fingertip. It has an intuitive user-interface which enables you to easily connect to your security system and edit its settings. Now you can control your Paradox security system from any Android / iOS smartphone.

TM70 Overview

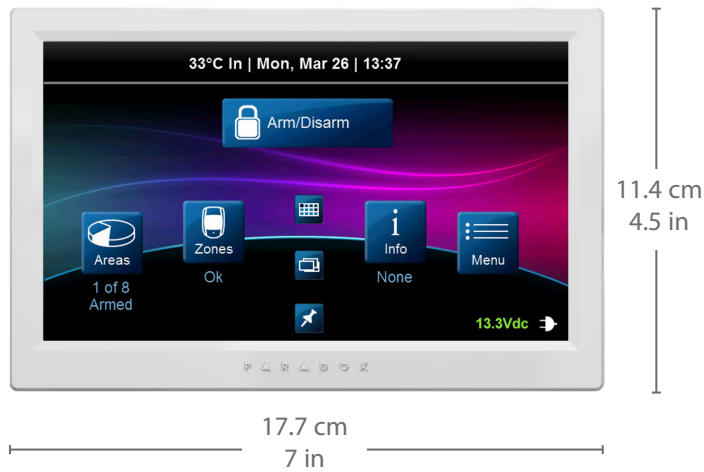

TM70: Intuitive Touchscreen

- ## SpotOn Locator™

Upload photos, images, or schematics to eliminate the need for deciphering LED zone lights. These images display any door, window, or motion detector that are active. Since the images are uploaded by the user, they are truly customized, and can be unique to each installation. SpotOn Locator™ is integrated in the original firmware, and when purchased, is unlocked with an authorization code.

- ## OneScreen Monitoring™

Provides a real-time visual display of the system's status on one screen. It allows the user to choose which partitions will be displayed showing arming level, alarm, ready, and troubles. It also displays zone statuses; open, close, bypass, alarm, and tamper. OneScreen Monitoring™ also features Solo Test™ mode, which allows installers and users to easily test all system zone's via the TM70 Touch's screen. OneScreen Monitoring™ is integrated in the original firmware, and when purchased, is unlocked with an authorization code.

Specifications

Display	16-bit, color LCD; 8.6 x 15.4 cm (3.1 x 5.9 in.), 800 x 480 pixels
Input Voltage	9 to 15 Vdc
Current Consumption	250 mA at max brightness + 80 mA sounder
Keypad Zone Input	1 for a detector or external temperature sensor
Tamper	Built-in, cover and wall
Humidity	5 to 90%
Operating Temperature	-10 to 55 °C (14 to 131 °F)
Compatibility	Swan, EVO, Spectra, Magellan

Note: All control panel outputs are rated to operate between 11.4 Vdc and 12.5 Vdc.



Specifications PRX278000033-P2C

The PRX278000033-P2C is a metal box enclosure for provision multiple module and panel mounting.

Features:

- Many punch-out holes for simple wiring
- Easy door removal
- Sizes: 28cm X 28cm X 7.6cm (11" x11" x 3")

P ▲ R ▲ D O X™



Specifications PRXK-TK278

The PRXK-TK278 is a BOM Kit for 1x tamper switch PRX2502302000-P2C and 1x tamper bracket PRX2781030000-P2C to suit with Paradox Metal Box Enclosure PRX2780000033-P2C; to protect against tampering (opening door or removal from wall).

P ▲ R ▲ D O X™



DIGI PLEX EVO

EVO48
EVO192

User Guide

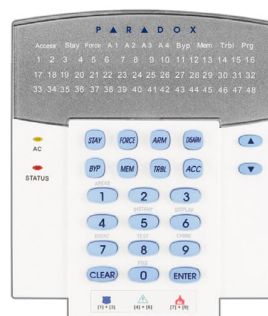
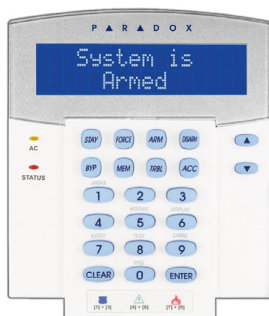

P ▲ R ▲ D O X™

TM50 (5") / TM70 (7")

Touch Screen Keypads



TM50 / TM70

The TM50 / TM70 are touch screen input keypads designed to communicate with Paradox control panels, and offer user friendly interface. Both offer vivid colors and two sizes to select, 7" – TM70 or 5" – TM50.

The TM70 due to its larger screen allows for more information to be displayed on one screen and is more convenient in comparison to the TM50.

Both touch screen displays are compatible with Spectra, Magellan and EVO Paradox systems, and both support Paradox next generation Swan panels with RS-485 fast encrypted bus, and features like complete menu programming, remote keypad firmware upgrade and screen saver images download from the Insite GOLD application.

The TM70 / TM50 have screen savers with auto mode, adjustable brightness with auto dim mode and full dark sleep mode, indoor temperature display, bus voltage monitoring and easy multi-partition control.

The TM70 LCD color display resolution is 800 x 400 pixels while the TM50 resolution is 472 x 272 pixels. Both come with an external SD media card (4 GB), 2 GB free space for uploading jpegs for screen savers.

The TM70 is offered in white and the TM50 in white or black colors, other colors may be custom ordered.

Features

- ▶ 7" (TM70) / 5" (TM50) with vivid color display
- ▶ Compatible with Swan, EVO, Spectra and Magellan
- ▶ Built-in zone input
- ▶ Customizable labels (zones, partitions, users, doors and PGMs)
- ▶ External SD Media Card slot (4 GB with 2 GB of free space) for uploading photos; acts like a digital picture frame
- ▶ Firmware upgradable via SD card
- ▶ Indoor temperature reading
- ▶ In-wall bracket (optional)



TM70 installed with in-wall optional bracket

Technical Specifications

	TM70	TM50
Power Input	9 to 15 VDC	
Consumption	250 mA at max brightness + 80 mA sounder	150 mA at max brightness, +80 mA sounder
Wire Connection	18 Gauge	22 Gauge, 18 Gauge recommended
Display	7" 800 x 480	5" 480 x 272
Dimensions	17.7 x 11.4 x 1.5 cm (7 x 4.5 x 0.6 in.)	14.2 x 9.5 x 1.4 cm (5.6 x 3.75 x 0.56 in.)
Humidity	5-90%	
Indoor Temperature	Yes	
SD Card	4 GB; 2 GB free	
Input	Zone, configurable	
Tamper	Built-in, cover and wall	
Compatibility	Swan, EVO, Spectra, Magellan	
Remote Upgrade	Swan only	
Jpeg Download	Swan via Bus, EVO/Spectra SD Card	
Auto Dim	Yes	
Chime	Yes	



P ▲ R ▲ D O X™

TTM70-G2K rev.04 - Printed in Canada 04/2019.
 Specifications may change without prior notice. US, Canadian and international patents may apply. Paradox is a trademark or registered trademark of Paradox Security Systems (Bahamas) Ltd. or its affiliates in Canada, the United States and/or other countries. © 2019 Paradox Security Systems Ltd. All rights reserved.



www.paradox.com



Specifications DFMWP16

The DFMWP16 is combo siren and strobe (slim design).

- New design
- Siren tone selectable for different applications
- Sound volume adjustable: low dB for testing and high dB for normal operation
- Bright: new LED strobe design
- Independent siren and strobe operation
- High quality UV treated case
- Weatherproof
- Front and back tampers
- EOLRs built in, suitable for most major alarm panels

Operating voltage: 9-15VDC

SPL @ 1meter: 110dB

Siren current draw: 150mA

Strobe current draw: 50mA

Siren tone selectable: Tone 1: warble; Tone 2: Hi/Lo

Dimension: 200 x 110 x 40mm





WP16 Combo Siren/Strobe

Voltage: 9-15VDC

Current: Max 150mA @ 12VDC

High Volume: 110±3 dB @ 1meter

Low Volume: 95±3 dB @ 1meter

Tone 1: Warble

Tone 2: Hi/Lo

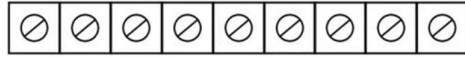
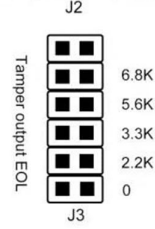
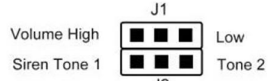

+ Siren - Input + Strobe - Input + LED - Night Comfort Tamper Output Spare





Specifications DFMWP08

The DFMWP08 is indoor top hat piezo.

Input voltage: 12VDC

SPL @ 1meter: 105dB

Current draw: 90mA





VRLA 12V7AH

SA12V7

Specifications

Nominal Voltage	12 V	
Nominal Capacity 20HR	7.0 AH	
Dimensions	Length	151±1mm (5.94 inches)
	Width	65±1mm (2.56 inches)
	Container Height	95±1mm (3.74 inches)
	Total Height (with terminal)	100±1mm (3.94 inches)
Approx Weight	Approx 2.10 kg (4.63 lbs)	
Terminal	F1	
Container Material	ABS Plastic	
Lead Material	Purity Lead 99.995%	
Sulfuric Acid	Distilled Sulfuric Acid (Zero metal content)	
Separator	AGM	
Rated Capacity	7.00 AH/0.350A	(20hr, 1.80V/cell, 25°C/77°F)
	6.53 AH/0.653A	(10hr, 1.80V/cell, 25°C/77°F)
	6.00 AH/1.20A	(5hr, 1.75V/cell, 25°C/77°F)
	5.37 AH/1.79A	(3hr, 1.75V/cell, 25°C/77°F)
	4.55 AH/4.55A	(1hr, 1.60V/cell, 25°C/77°F)
Max. Discharge Current	105A (5s)	
Internal Resistance	Approx 23mΩ	
Operating Temp.Range	Discharge	: -15 - 50°C (5 - 122°F)
	Charge	: 0 - 40°C (32 - 104°F)
	Storage	: -15 - 40°C (5 - 104°F)
Nominal Operating Temp.Range	25±3°C (77±5°F)	
Cycle Use	Initial Charging Current less than 2.1A. Voltage 14.4V - 14.7V at 25°C (77°F) Temp.Coefficient -30mV/°C	
Standby Use	No limit on Initial Charging Current Voltage 13.5V - 13.8V at 25°C (77°F) Temp.Coefficient -20 mV/°C	
Capacity affected by Temperature	40°C (104°F) 103% 25°C (77°F) 100% 0°C (32°F) 86%	
Self Discharge	Sentry AGM series batteries may be stored for up to 6 months at 25°C (77°F) and then a freshening charge is required. For higher temperatures the time interval will be shorter.	



Applications

- All purpose
- Standby Applications
- Recreation Vehicles
- Uninterruptible Power Supply (UPS)
- Electric Power System (EPS)
- Fire & Security
- Generators
- Medical Equipment

Dimensions

F1 Terminal

Unit: mm (inches)

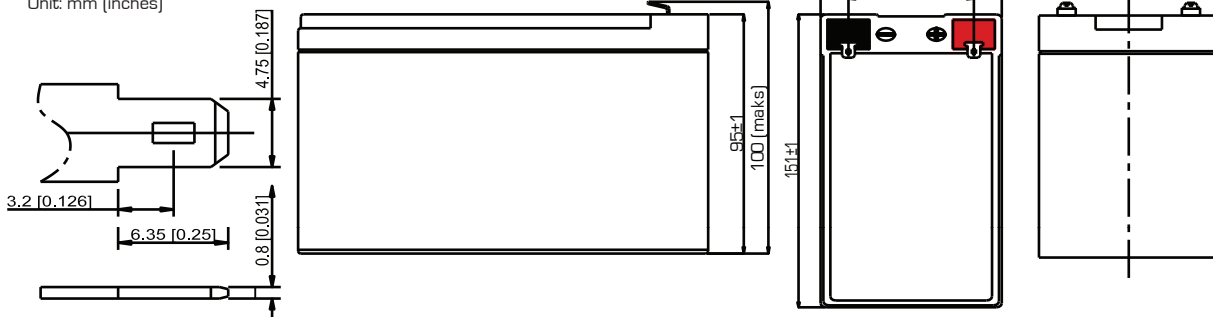

Constant Current Discharge (Amperes) at 25°C (77°F)

F.V/Time	5min	10min	15min	20min	30min	45min	1h	2h	3h	4h	5h	6h	8h	10h	20h
1.85V/cell	18.0	12.8	10.48	8.79	6.53	4.79	3.86	2.29	1.69	1.36	1.14	0.98	0.774	0.640	0.345
1.80V/cell	21.4	14.3	11.4	9.44	6.94	5.05	4.03	2.38	1.74	1.40	1.17	1.01	0.791	0.653	0.350
1.75V/cell	24.2	15.6	12.2	10.0	7.29	5.27	4.18	2.45	1.79	1.43	1.20	1.03	0.805	0.663	0.357
1.70V/cell	26.7	16.7	12.9	10.5	7.59	5.46	4.32	2.51	1.83	1.46	1.22	1.05	0.817	0.672	0.361
1.65V/cell	28.8	17.7	13.5	10.9	7.86	5.62	4.46	2.57	1.86	1.48	1.23	1.06	0.826	0.680	0.365
1.60V/cell	30.6	18.6	14.1	11.3	8.09	5.76	4.55	2.61	1.89	1.50	1.25	1.07	0.834	0.685	0.367

Constant Power Discharge (Watts/Cell) at 25°C (77°F)

F.V/Time	5min	10min	15min	20min	30min	45min	1h	2h	3h	4h	5h	6h	8h	10h	20h
1.85V/cell	34.2	24.5	20.2	17.1	12.8	9.44	7.64	4.56	3.37	2.72	2.29	1.99	1.565	1.296	0.701
1.80V/cell	40.2	27.2	21.9	18.3	13.5	9.91	7.96	4.72	3.47	2.79	2.34	2.03	1.593	1.318	0.708
1.75V/cell	45.1	29.5	23.3	19.3	14.2	10.3	8.23	4.85	3.55	2.85	2.39	2.06	1.616	1.344	0.719
1.70V/cell	49.2	31.3	24.5	20.1	14.7	10.6	8.48	4.96	3.62	2.89	2.42	2.09	1.633	1.347	0.725
1.65V/cell	52.6	32.9	25.5	20.8	15.2	10.9	8.73	5.05	3.68	2.93	2.45	2.11	1.649	1.359	0.731
1.60V/cell	55.5	34.3	26.3	21.5	15.5	11.2	8.88	5.12	3.72	2.96	2.47	2.13	1.660	1.367	0.734

Discharge Characteristics

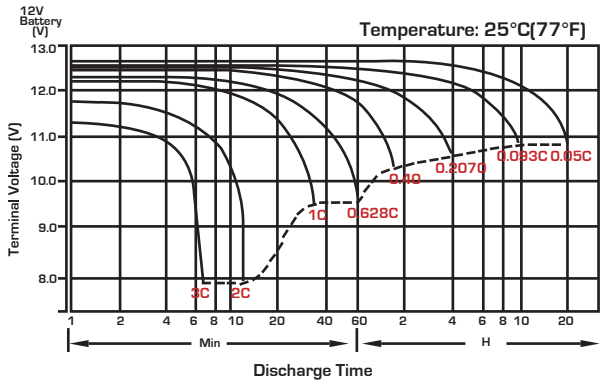

Float Charging Characteristics

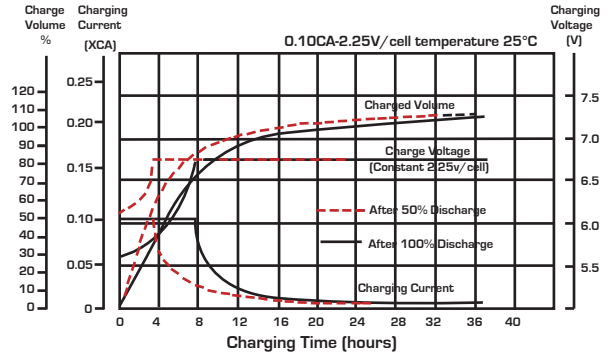

Temperature Effects in Relation to Battery Capacity

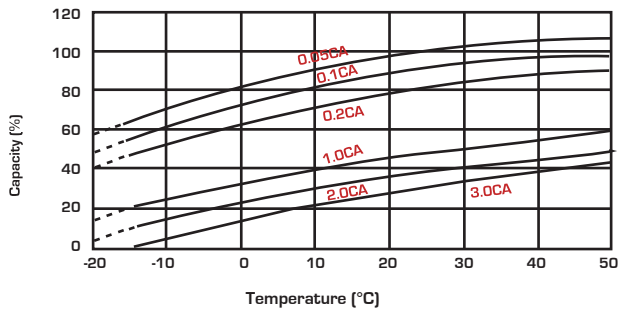

Effect of Temperature on Long Term Float Life

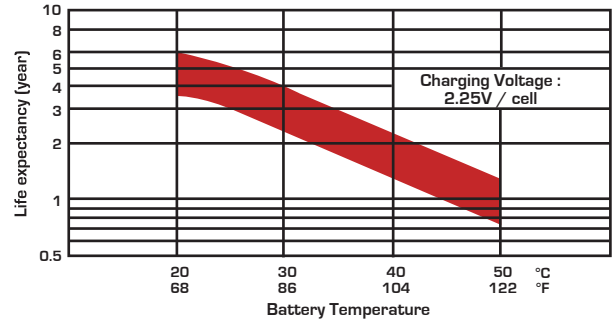

Cycle Life in Relation to Depth of Discharge

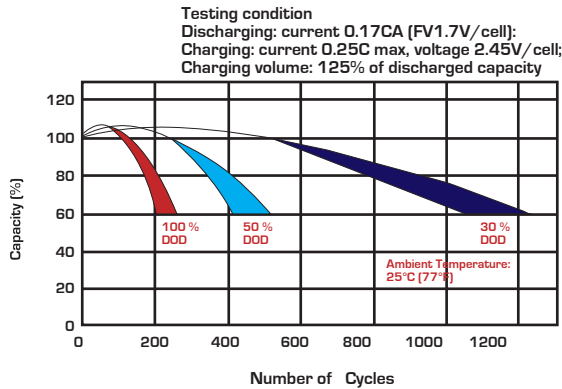

Self Discharge Characteristics

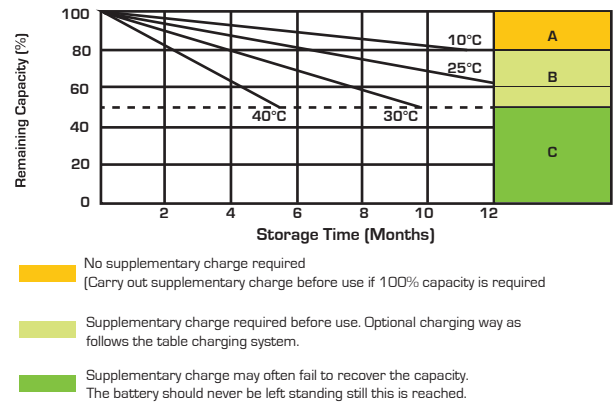

Charging System

DOD	Current Limit (A)	Constant Voltage (V)	Fully Charged Time (h)
20	0.15C ₁₀	13.5-13.8 vpc (12V)	10
	0.20C ₁₀	6.75-6.9 vpc (6V)	8
50	0.15C ₁₀	13.5-13.8 vpc (12V)	15
	0.20C ₁₀	6.75-6.9 vpc (6V)	12
80	0.15C ₁₀	13.5-13.8 vpc (12V)	16
	0.20C ₁₀	6.75-6.9 vpc (6V)	14
100	0.15C ₁₀	13.5-13.8 vpc (12V)	20
	0.20C ₁₀	6.75-6.9 vpc (6V)	18

State of Charge (SOC)

Open Circuit Voltage (V/cell)	Open Circuit Voltage (12V/cell)	Open Circuit Voltage (6V/cell)	State of Charge (% of full charge capacity)
2.14-2.15	12.84-12.90	6.42-6.46	100
2.12-2.13	12.72-12.78	6.36-6.39	90
2.11	12.66	6.33	80
2.09	12.54	6.27	70
2.07	12.42	6.21	60
2.05	12.30	6.15	50



Sealed Performance Batteries

Domestic Sales | Ph: +61 (0)7 3386 1102 | Fax: +61 (0)7 3102 9913
 sales@spb.net.au | www.sealedperformance.com.au
 National Warehouse | 1 Ant Road | Yatala, Brisbane QLD 4207
 Melbourne Office | 2/9 Compark Circuit | Mulgrave, Melbourne VIC 3170

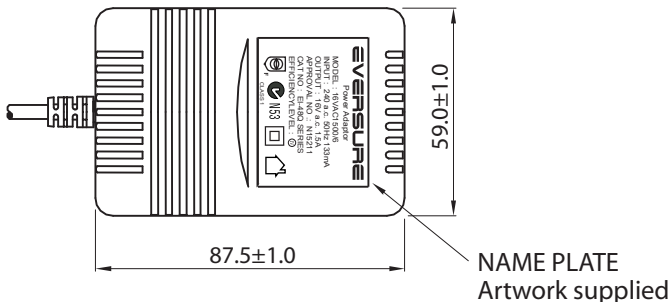
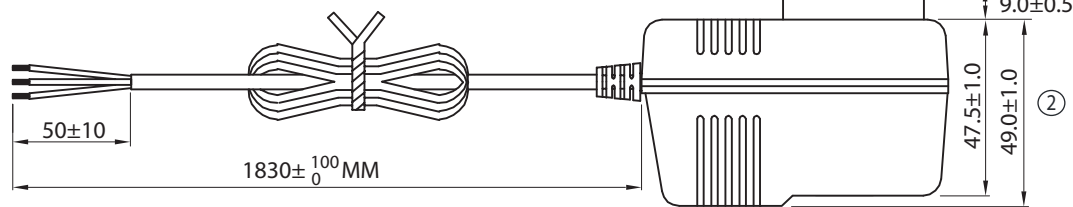
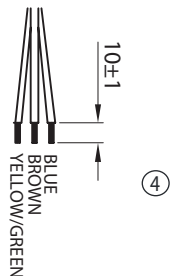

	REVISED	DRAWN	APPROVED
①	AMENDED PACKING QTY AND CARTON SIZE	JACKY 10/08/09	GARY 10/08/09
②	ADDED DATE CODE ON CASE AND DIMENSIONS	JACKY 07/12/09	GARY 07/12/09
③	ADDED PASSED LABEL ON CARTON	TODD 22/12/10	JACKY 22/12/10
④	AMENDED AC PINS DIMENSION & ADDED WIRES COLORS	ANLEI 01/11/12	ANLEI 01/11/12
⑤	CHANGED CROSS-SHAPED SCREW TO SHAPE SCREW ON CASE	MARK 31/08/15	FREDERICK 31/08/15

- NOTES:
1. OUTPUT CORD: 20AWGX3C 1.83M Lead Free GREY (RAL7035)
 2. CASE: GREY (RAL7035)
 3. SECURITY SCREW IS AN ESSENTIAL REQUIREMENT, BOTH "" AND "" SHAPE ARE ACCEPTABLE

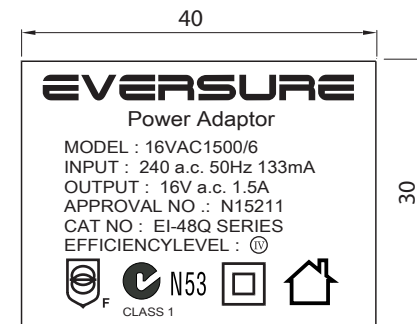

LABEL ARTWORK
Black word on Silver base label

TE DRAWING NO: TE40-0001 R5					PART NO: 16VAC1500MPS/6					
DESCRIPTION: AC ADAPTOR EI-48Q, 16VAC1500mA, 3 WIRE - MEPS										
SIZE	A4	DATE	30/04/09	CHECKED	KEVIN 30/04/09		ORDER REF:	0420	SHEET 1 OF 3	TOLERANCES UNLESS OTHERWISE STATED X.= +/- .X.= +/-0.5 .XX.= +/-0.2
UNIT	MM	DRAWN	KEVIN	APPROVED	FRANK 30/04/09		CUSTOMER: TE			
SCALE	NTS	MANU:				DATE:				



THIS DRAWING AND SPECIFICATIONS ARE THE PROPERTY OF TELEPHONE EQUIPMENT (NSW) Pty Ltd AND SHALL NOT BE REPRODUCED OR USED IN ANY MANNER WITHOUT THE PRIOR WRITTEN CONSENT OF TELEPHONE EQUIPMENT (NSW) Pty Ltd

ITEM		SPECIFICATION
1. Primary rated input voltage		AC240V 50Hz 133mA
2. Secondary rated output voltage and current		Unloaded voltage: AC 18 V ± 5% Loaded Voltage : AC 16 V ± 5% AT 1500 mA
3. Ripple voltage		*** mV (RMS) MAX. AT Rated Loading
4. Insulation resistance		Primary - secondary: DC 500 V 100 MΩ Min
5. Dielectric withstand test		Primary - secondary: AC 3.64 KV 1 seconds
6. Temperature rise		At rated loading 90°C max. For input coil (By resistance method) and 55°C max. on case surface (By use of thermometer)
7. EFFICIENCY		≥ 79%
8. Leadout	Primary	SAA PLUG IN TYPE
	Secondary	PVC cable length: 1.8 Meter Colour : GREY (RAL7035) Wire size: AWG#20/3C Plug : STRIPPED AND TINNED
9. Test circuit		
10. Case		SAA48 colour = GREY (RAL7035)

	REVISED	DRAWN	APPROVED
①	AMENDED PACKING QTY AND CARTON SIZE	JACKY 10/08/09	GARY 10/08/09
②	ADDED DATE CODE ON CASE AND DIMENSIONS	JACKY 07/12/09	GARY 07/12/09
③	ADDED PASSED LABEL ON CARTON	TODD 22/12/10	JACKY 22/12/10
④	AMENDED AC PINS DIMENSION & ADDED WIRES COLORS	ANLEI 01/11/12	ANLEI 01/11/12
⑤	CHANGED CROSS-SHAPED SCREW TO SHAPE SCREW ON CASE	MARK 31/08/15	FREDERICK 31/08/15

TE DRAWING NO: TE40-0001 R5

PART NO: 16VAC1500MPS/6

DESCRIPTION: AC ADAPTOR EI-48Q,16VAC1500mA, 3 WIRE - MEPS



THIS DRAWING AND SPECIFICATIONS ARE THE PROPERTY OF TELEPHONE EQUIPMENT (NSW) Pty Ltd AND SHALL NOT BE REPRODUCED OR USED IN ANY MANNER WITHOUT THE PRIOR WRITTEN CONSENT OF TELEPHONE EQUIPMENT (NSW) Pty Ltd

SIZE	A4	DATE	30/04/09	CHECKED	KEVIN 30/04/09		ORDER REF:	0420	SHEET 2 OF 3	TOLERANCES UNLESS OTHERWISE STATED X.= +/- .X= +/-0.5 .XX= +/-0.2
UNIT	MM	DRAWN	KEVIN	APPROVED	FRANK 30/04/09		CUSTOMER:	TE		
SCALE	NTS	MANU:				DATE:				

	REVISED	DRAWN	APPROVED
①	AMENDED PACKING QTY AND CARTON SIZE	JACKY 10/08/09	GARY 10/08/09
②	ADDED DATE CODE ON CASE AND DIMENSIONS	JACKY 07/12/09	GARY 07/12/09
③	ADDED PASSED LABEL ON CARTON	TODD 22/12/10	JACKY 22/12/10
④	AMENDED AC PINS DIMENSION & ADDED WIRES COLORS	ANLEI 01/11/12	ANLEI 01/11/12
⑤	CHANGED CROSS-SHAPPED SCREW TO SHAPE  SCREW ON CASE	MARK 31/08/15	FREDERICK 31/08/15

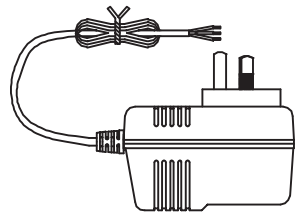

1 PC/WHITE BOX

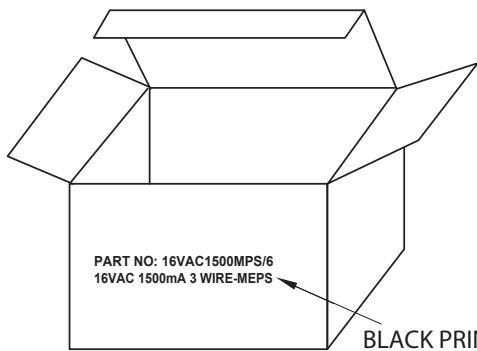

BLACK PRINTING

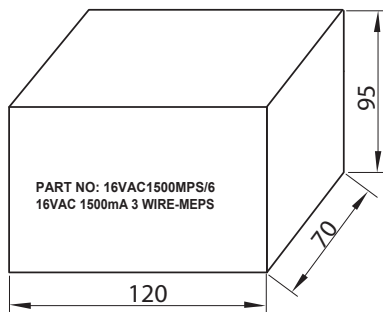

20 BOXES/CARTON ①

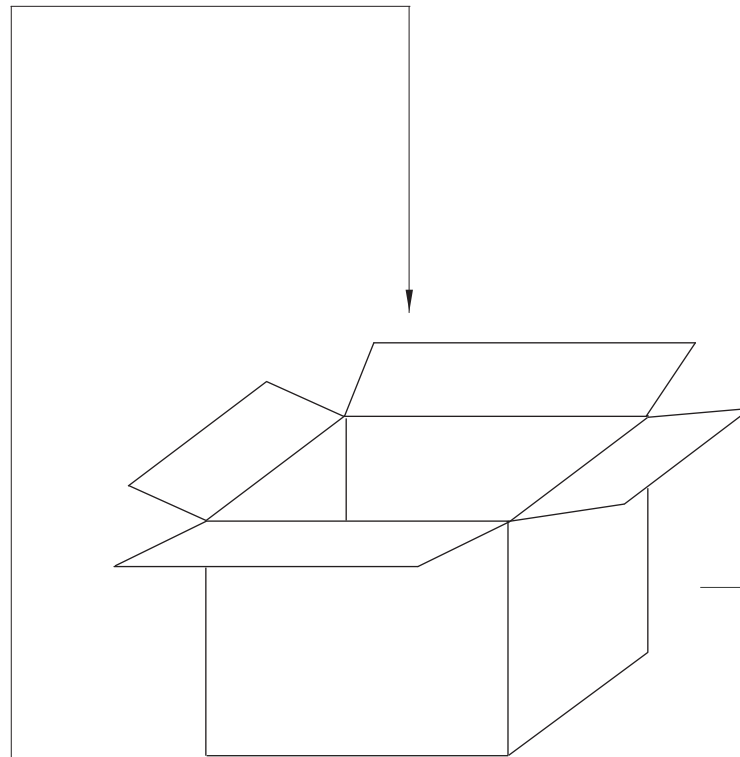

SHIPPING CARTON
PLEASE FOLLOW ORDER TO PRINT SHIPPING MARKS.

ADHESIVE TAPE

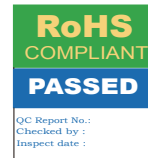
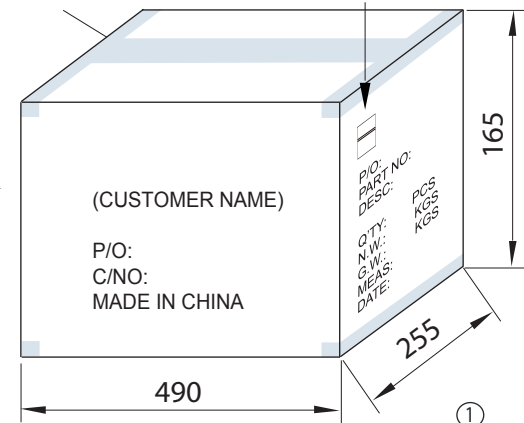

③

ONLY ONE RoHS+PASSED LABEL ON CARTON
RoHS LABEL(55X25MM)
GREEN GROUNDING YELLOW TEXT
PASSED LABEL(55X36MM)
BLUE GROUNDING WHITE TEXT
WHITE GROUNDING BLUE TEXT

①

TE DRAWING NO: TE40-0001 R5

PART NO: 16VAC1500MPS/6

DESCRIPTION: AC ADAPTOR EI-48Q,16VAC1500mA, 3 WIRE - MEPS



THIS DRAWING AND SPECIFICATIONS ARE THE PROPERTY OF TELEPHONE EQUIPMENT (NSW) Pty Ltd AND SHALL NOT BE REPRODUCED OR USED IN ANY MANNER WITHOUT THE PRIOR WRITTEN CONSENT OF TELEPHONE EQUIPMENT (NSW) Pty Ltd

SIZE	A4	DATE	30/04/09	CHECKED	KEVIN 30/04/09		ORDER REF:	0420	SHEET 3 OF 3	TOLERANCES UNLESS OTHERWISE STATED X.= +/-1 .X.= +/-0.5 .XX.= +/-0.2
UNIT	MM	DRAWN	KEVIN	APPROVED	FRANK 30/04/09		CUSTOMER:	TE		
SCALE	NTS	MANU:					DATE:			



Specifications TELLC0280

The TELLC0280 is the telephone lead with 606 Socket and 2 Meter length of Telephone Cord.

Colour: Ivory.

