

Digiplex EVO

High Security and Access System

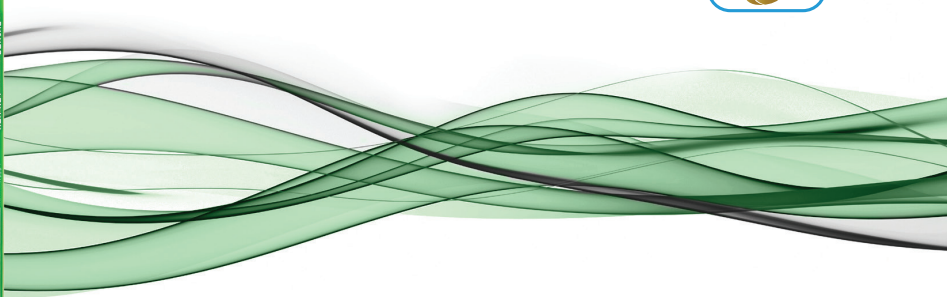
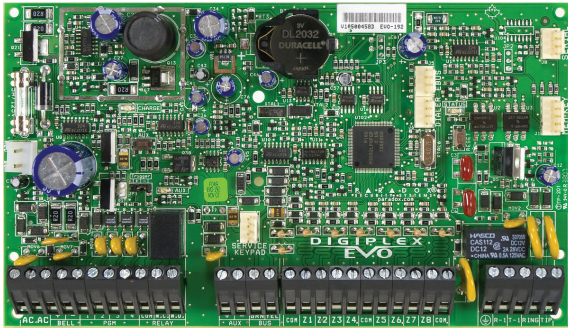

Description

Digiplex EVO systems (EVO192) provide the highest level of protection for banks, government sites, luxurious residential homes and any place where maximum security is essential. The modular concept of these systems provide installers with labour-saving features that make expanding, installing and servicing these systems quick and convenient.

Expand your system by adding expansion modules anywhere, in any combination, on the 4-wire combus. Modules are connected to the combus at the most convenient location and their zone inputs are assigned to the desired zone and partition. Keyswitches, remote controls, and unused module inputs do not use zones. Once installed, all combus modules (including motion detectors) can be programmed remotely via a keypad, or the BabyWare PC software.

Digiplex EVO integrates access control solutions. Your alarm system user database can be used to manage the access for up to 32 doors, and the monitoring of these doors can be included in any partition. By merging security and access control, Digiplex EVO systems increase the level of protection offered by security systems to a whole new level.

Feature Comparison

Feature	EVO192
Maximum Zones*	192
On-board Zones	8 (16 with ATZ)
Partitions	8
User Codes	999
Multibus	✓
Stay Arming	✓
Panel In-field Firmware Upgradable	✓
Access Control (Doors)	32
Access Levels / Schedules	16 / 32
Events Buffered	3584
PGMs	32 (5 on-board)
PGM +/- Trigger	✓
Virtual Zones**	32
Expansion Modules*	254
Supports IP / GPRS / GSM Communication (PCS Series)	✓
Supports VDMP3 Plug-in Voice Module	✓
Supports IP150 Internet Module	✓
Software	NEware, BabyWare
Listen-in Capabilities	✓

* Can be any combination of hardwire, wireless or addressable zones, or modules
 ** Automate PGM activations without occupying security zones



System Overview

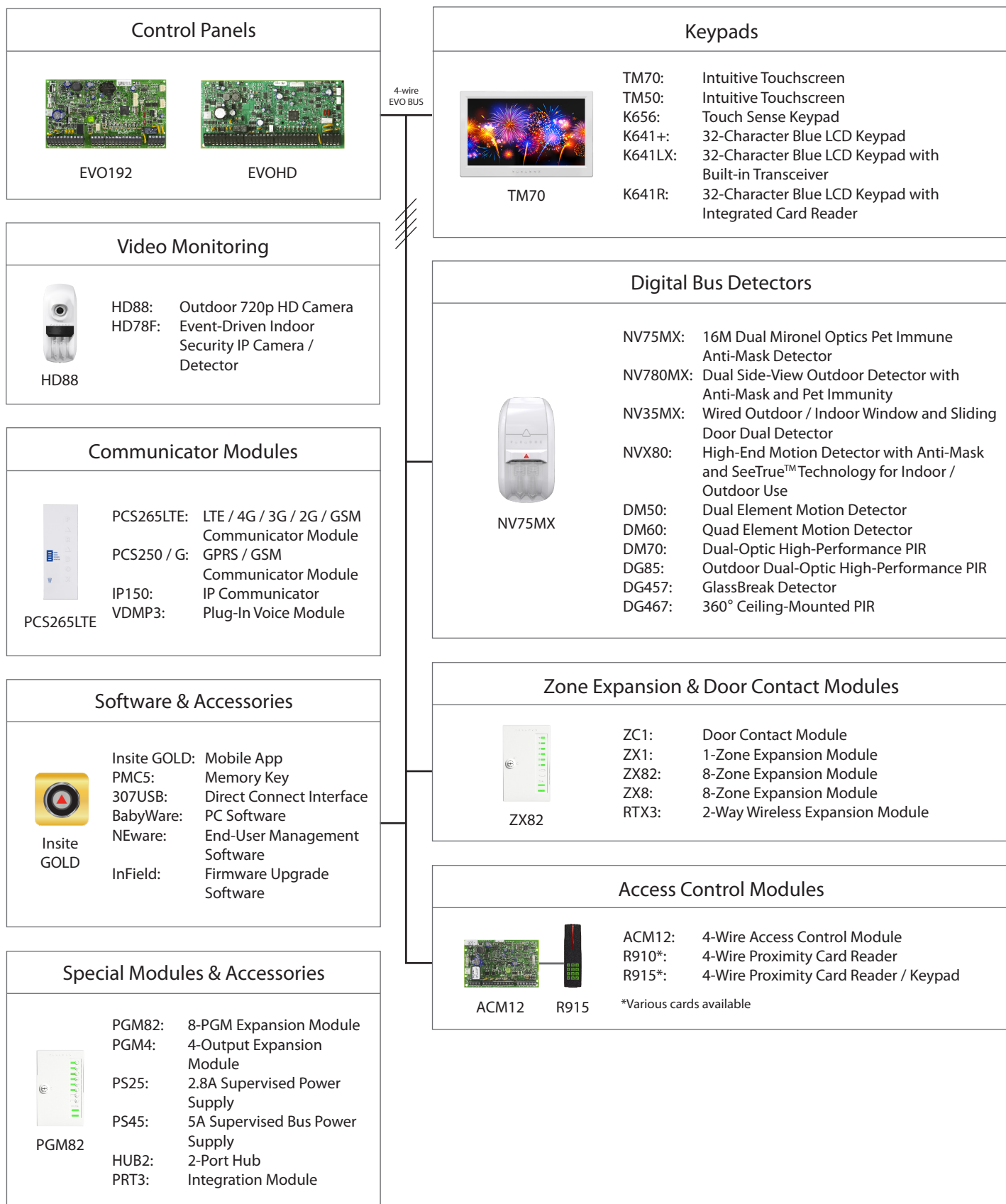

Feature Details



Internet Communication (IP150)

The IP150 Internet Module allows you to control and monitor your security system remotely through any web browser. It allows for email notifications of important system events such as alarms, arm/disarm events, and troubles. For example, receive an email at work when your kids get back from school. You can also view the live status of your system and arm/disarm it. For example, you have just left your office for the weekend but are not sure you remembered to arm the system. Simply check the status of your system from a laptop and arm it.



Wireless Communication (PCS Series)

The PCS series modules provide the Digiplex EVO control panels with wireless communication capabilities to report system events via IP, GPRS, and/or GSM. Whether it be uploading/downloading via IP or GPRS, receiving system status and events by voice or text message, or reporting to the monitoring station via IP, GPRS, or GSM, the PCS series enhances the communication capabilities of any Digiplex EVO installation.



Voice Communication (VDMP3)

The VDMP3 is a plug-in, voice-assisted module that can be programmed to call up to 5 telephone numbers in the event of an alarm. For example, when an alarm occurs at your store during off-hours, every employee can receive notification via telephone; e.g., "Area 1 in alarm. Zone 3. Press 1 to disarm the system..." You can also call the VDMP3 from an outside line, enabling you to arm or disarm the system as well as activate PGMs. The VDMP3 essentially turns any outside telephone into a keypad. The VDMP3 is easy to install; plug it in directly onto the panel, set the phone numbers, and select the activation event.



In-field Upgradable

Digiplex EVO is not only easy to install, but is also fully in-field upgradable for simple on-site updates. The process is effortless; connect the PC to the panel and you are a few clicks away from performing a complete system upgrade within minutes. No need to change panels or hardware; all the updates are done using Paradox's InField Firmware Upgrade Software.



Access Control

Access control can be added to the Digiplex EVO system to provide additional control over who has access to your premises, even when your security system is not armed and you are not there to supervise. With added access control you can limit access to certain areas, disallow access to others, or control entire groups of people according to their schedule or privileges. Make your premises inadmissible to all except those with access cards, track anybody who enters your premises, print detailed reports of access control activities, and more.



App-based System Control

The Insite GOLD app enables you to remotely access your Paradox security system and view your system cameras. Insite GOLD provides lots of functionality and information at one's fingertip. It has an intuitive user-interface which enables you to easily connect to your security system and edit its settings. Now you can control your Paradox security system from any Android / iOS smartphone.

TM70 Overview

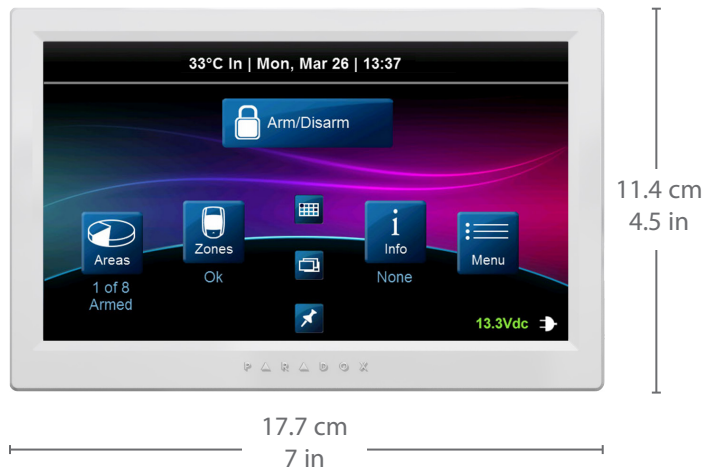

TM70: Intuitive Touchscreen

- ## SpotOn Locator™

Upload photos, images, or schematics to eliminate the need for deciphering LED zone lights. These images display any door, window, or motion detector that are active. Since the images are uploaded by the user, they are truly customized, and can be unique to each installation. SpotOn Locator™ is integrated in the original firmware, and when purchased, is unlocked with an authorization code.

- ## OneScreen Monitoring™

Provides a real-time visual display of the system's status on one screen. It allows the user to choose which partitions will be displayed showing arming level, alarm, ready, and troubles. It also displays zone statuses; open, close, bypass, alarm, and tamper. OneScreen Monitoring™ also features Solo Test™ mode, which allows installers and users to easily test all system zone's via the TM70 Touch's screen. OneScreen Monitoring™ is integrated in the original firmware, and when purchased, is unlocked with an authorization code.

Specifications

Display	16-bit, color LCD; 8.6 x 15.4 cm (3.1 x 5.9 in.), 800 x 480 pixels
Input Voltage	9 to 15 Vdc
Current Consumption	250 mA at max brightness + 80 mA sounder
Keypad Zone Input	1 for a detector or external temperature sensor
Tamper	Built-in, cover and wall
Humidity	5 to 90%
Operating Temperature	-10 to 55 °C (14 to 131 °F)
Compatibility	Swan, EVO, Spectra, Magellan

Note: All control panel outputs are rated to operate between 11.4 Vdc and 12.5 Vdc.



Specifications PRX278000033-P2C

The PRX278000033-P2C is a metal box enclosure for provision multiple module and panel mounting.

Features:

- Many punch-out holes for simple wiring
- Easy door removal
- Sizes: 28cm X 28cm X 7.6cm (11" x11" x 3")

P ▲ R ▲ D O X™



Specifications PRXK-TK278

The PRXK-TK278 is a BOM Kit for 1x tamper switch PRX2502302000-P2C and 1x tamper bracket PRX2781030000-P2C to suit with Paradox Metal Box Enclosure PRX2780000033-P2C; to protect against tampering (opening door or removal from wall).

P ▲ R ▲ D O X™



DIGI PLEX EVO

EVO48
EVO192

User Guide

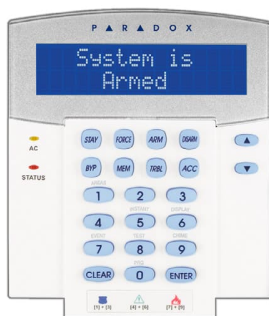

P ▲ R ▲ D O X™

Description

The Paradox PMD2P is an analog single-optic PIR motion detector with built-in pet immunity for use with Magellan wireless receivers/transceivers. The PMD2P is immune to animals weighing up to 18kg (40 pounds), and features automatic temperature compensation.

The PMD2P is battery-powered and features an innovative three minute energy save mode (after two detections within a five-minute period). Also, the ALIVE software in the PMD2P ensures that the alarm LED continues to display when it is in energy save mode without compromising battery life.



Installation

At the installation height of 2.1m (7ft) ±10%, the PMD2P provides full coverage from 1.2m (3.9 ft) to 11m (36 ft). Mounting lower than recommended height will decrease the long range performance; higher will decrease short range performance. Do not obscure the detector, partially nor fully.

IMPORTANT: Do not touch the sensor as this could result in malfunction. Clean the sensor surface using a soft cloth with pure alcohol. Also, avoid bending, cutting, or altering the antenna or mounting the detector near metal as this may affect transmission.

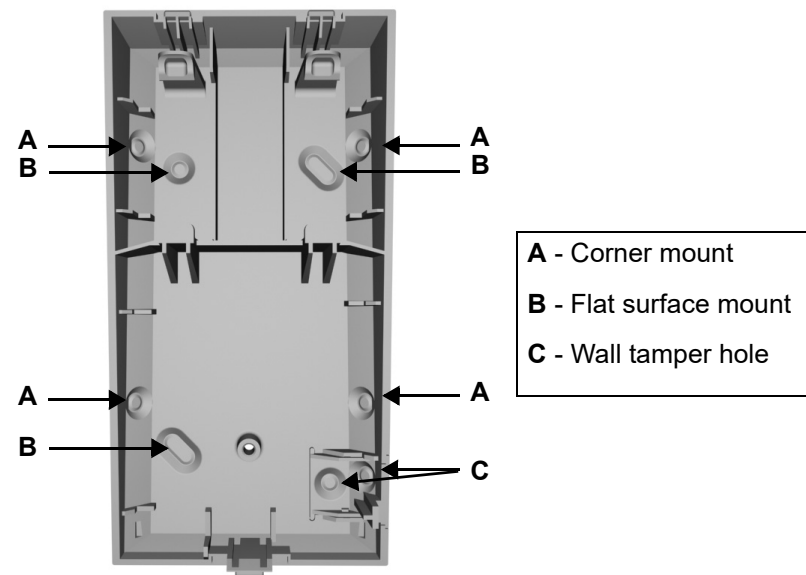

Dual Tamper Mechanism - Wall and Cover

The PMD2P is equipped with dual tamper protection; an alarm is generated if the front cover is removed or if the detector is removed from the wall. In order for the wall tamper removal feature to be functional, a screw needs to be inserted in the wall tamper hole (see PCB Overview at right).

Powering the Wireless Detector

Verifying proper polarity, insert three “AAA” alkaline batteries into the motion detector’s battery compartment. To replace the batteries, remove the old batteries, then press and release the tamper switch and wait 60 seconds in order to re-initialize the unit. After initialization is complete, insert batteries while verifying proper polarity (verify proper polarity on battery compartment connector as well). **IMPORTANT:** Make sure that when reinstalling the battery compartment that the batteries are facing the back-plate.

Power-up Sequence

After inserting the batteries, a power-up sequence begins (lasting 10-20 seconds). During this time, the red LED flashes and the detector will not detect an open zone or tamper.

Signal Strength Test

In order to verify proper signal reception, perform a signal strength test as described in the receiver’s Reference and Installation Manual. Prior to performing the test, ensure the batteries have been installed. Also verify that the motion detector has been assigned to a zone according to the instructions in the receiver’s Reference and Installation Manual. If the transmission is weak, relocating the transmitter by a few inches can greatly improve the reception.

Detector Settings - Quick View

Sensitivity	
S2 (Slider)	High = High sensitivity (default)
	Low = Low sensitivity
Fast/Slow Mode	
JP1 (Jumper)	Off = Slow mode
	On = Fast mode (default)
LED Feedback	
JP2 (Jumper)	Off = Disabled
	On = Enabled (default)

Detector Settings - Details

Sensitivity - S2 (Slider)	
High Sensitivity	In high sensitivity mode, you should not be able to cross more than one complete zone (consisting of two beams - left and right sensor elements) in the coverage area with any kind of movement. Use this setting for the majority of installations.
Low Sensitivity	In low sensitivity mode, the amount of movement required to generate an alarm is doubled. The use of low sensitivity mode is recommended in areas where the incidence of false alarms may be greater.
Fast/Slow Mode - JP1 (Jumper)	
Slow Mode	Recommended in areas where the incidence of false alarms may be greater.
Fast Mode	Recommended for the majority of installations.
LED Feedback - JP2 (Jumper)	
Alarm	The red LED will illuminate for a period of 3 seconds whenever the motion detector detects any kind of movement.
Low Battery	The PMD2P performs a battery test every 12 hours. If battery voltage drops below a certain level, the red LED flashes at 8 second intervals and the motion detector will send a low battery signal to the receiver. A trouble is generated and then transmitted to the central monitoring station.
Signal Transmission	The red LED blinks fast when transmitting.

PCB Overview

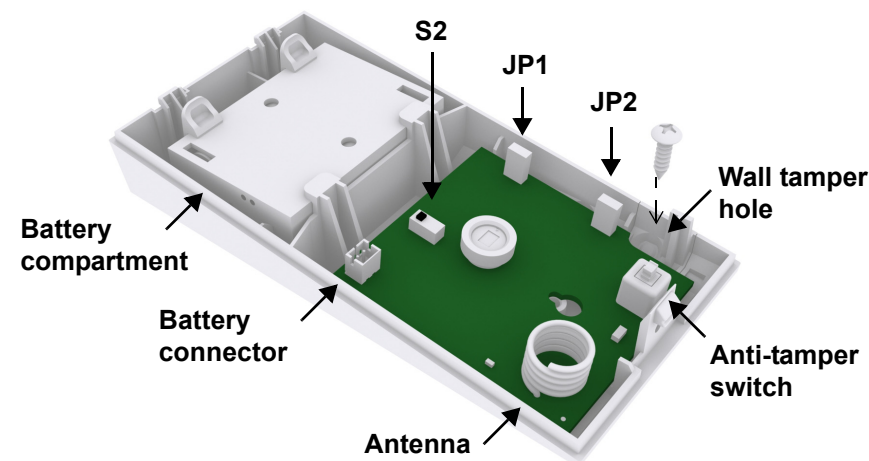

Alive Software

To conserve the motion detector's battery life, if the motion detector transmits two open zone signals (LED on for 3s) within a five-minute period, the detector will fall into Energy Save Mode for approximately three minutes and will not transmit any alarm signals. The red LED will continue to flash to indicate a detection. If the detector's cover is removed and then replaced while in Energy Save Mode, the first detection will trigger an alarm signal.

Walk-testing

To activate Walk-test Mode for three minutes, power up the detector or open and close the detector's cover. With sensitivity set to High (S2 = High), at 20°C, crossing more than one complete zone (consisting of two beams left and right sensor detecting elements) with slow/fast walking or running should initiate an alarm. With sensitivity set to Low (S2= Low), the amount of movement required to generate an alarm is doubled.

Beam Pattern

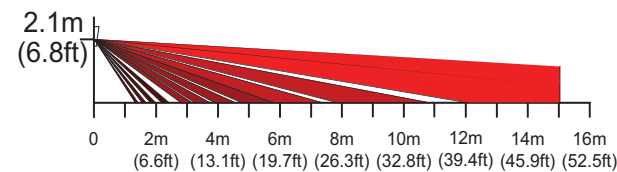
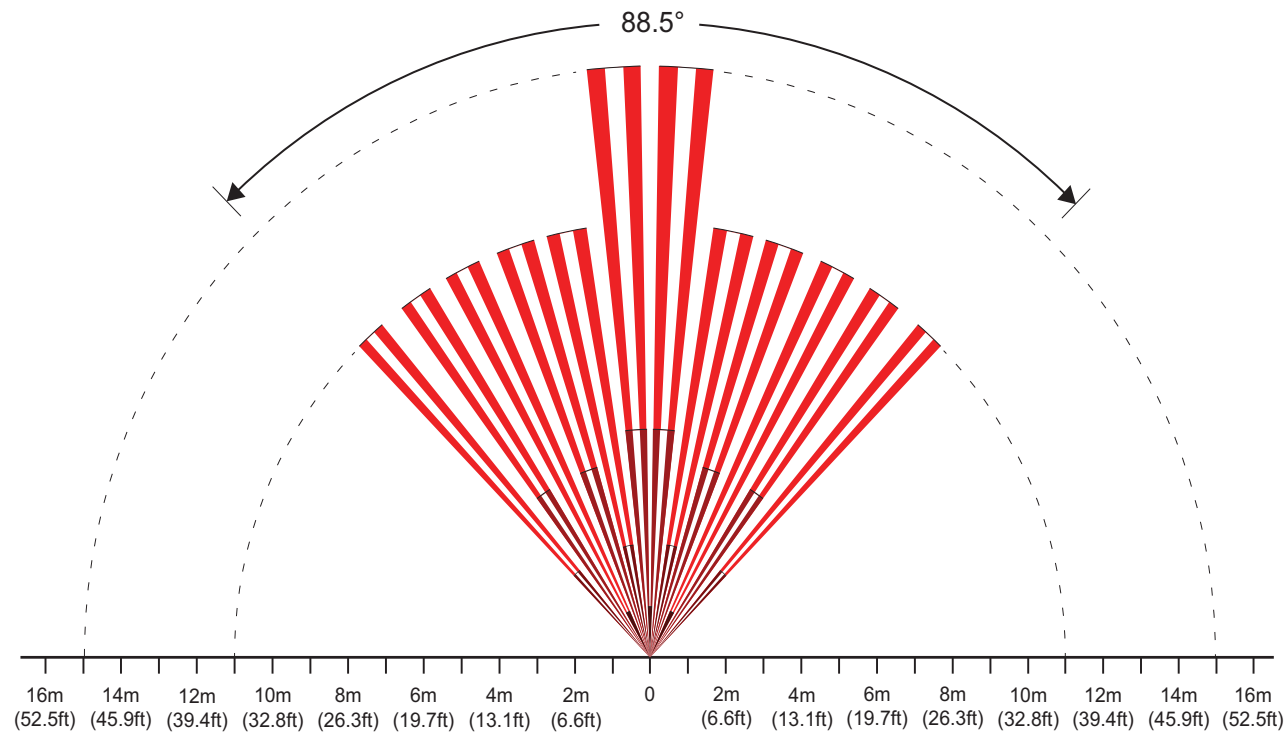

Specifications

Sensor Type	Dual rectangular element
Coverage	88.5° - 11m (36ft) x 11m (36ft); Center beams: 15m (49ft)
Pet Immunity	18kg (40lbs)
RF Frequency	433 or 868 MHz with Magellan only
Lens	2nd generation Fresnel lens, LODIFF® segments
Walk Speed	0.2m to 3.5m/s (0.6ft to 11.5ft/s)
Battery Type & Life	3 x 1.5vDC "AAA" alkaline batteries; 2 years*
Current Rating	31uA standby / 15mA alarm
Transmitter Range	35m (115ft) with MG6130 / MG6160 70m (230ft) with MG5000 / MG5050 / RTX3; in a typical residential environment
Operating Temp. & Humidity	0°C to 50°C (32°F to 122°F) / 5 to 90% max.
Functional Temp. & Humidity	0°C to 35°C (32°F to 95°F) recommended / 5 to 90% max.
Dimensions & Weight	6.5 x 12.5 x 5.2cm (2.5 x 4.9 x 2.0 in) / 105 g (3.7 oz) with batteries
RF Immunity	EN 50130-4: 10V/m 80MHz to 2.7GHz
Compatibility	See paradox.com for compatibility details
Certification	EN 50131 Grade 2 Class II; Certification body Intertek
* Battery life expectancy will vary according to the amount of traffic (movement) detected. Higher traffic levels will lower battery life.	

Warranty

For complete warranty information on this product, please refer to the Limited Warranty Statement which can be found on our website: paradox.com/terms or contact your local distributor. Specifications may change without prior notice.

Patents

US, Canadian and international patents may apply. Paradox is a trademark or registered trademark of Paradox Security Systems (Bahamas) Ltd.



RTX3

Wireless Expansion Module

Installation Manual
V6.30 and higher



Introduction

The RTX3 is a 2-way, 32 zone wireless expansion module which enables EVO and SP Series control panels to support wireless hardware such as sirens, motion detectors, water detectors, and remote controls.

RTX3 Board and Connectors

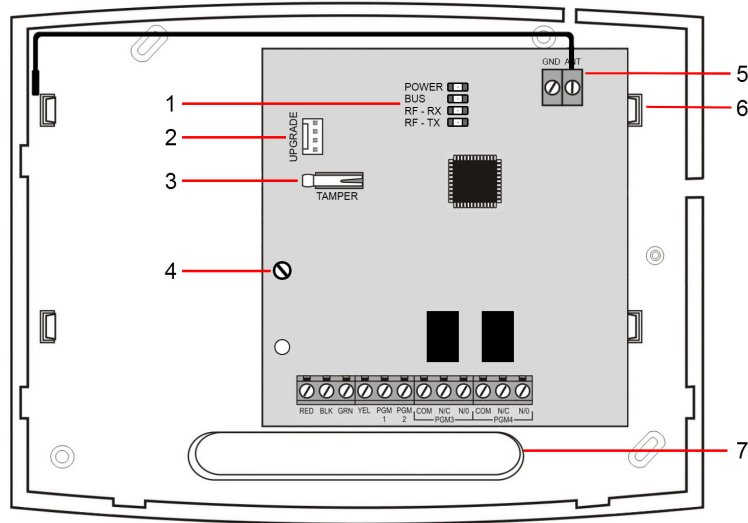

FIGURE 1

- | | |
|--------------------------------------|-----------------------|
| 1. LED display | 4. PCB screw |
| 2. Firmware upgrade serial connector | 5. Antenna |
| 3. Anti-tamper switch | 6. Mounting clips (2) |
| | 7. Wiring slot |

Installation

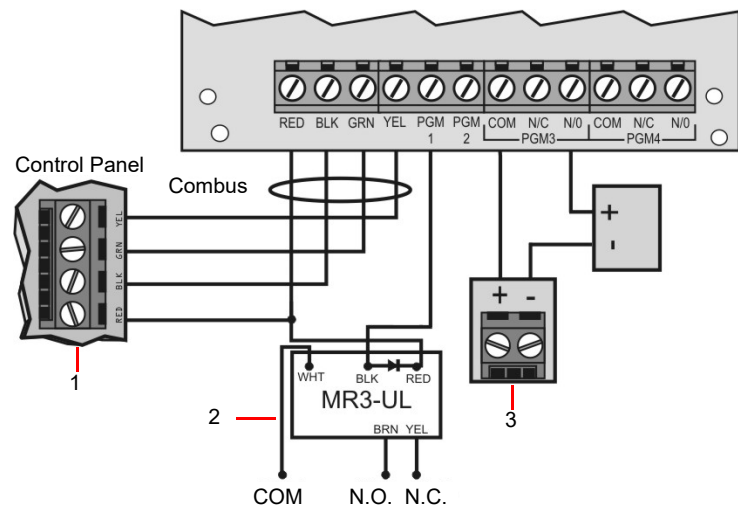

FIGURE 2

Installation Notes

Refer to the Figure 2 for the following connections and instructions.

- Control panel Digiplex connection.
- Use a relay if the current draw exceeds 150mA on PGM1 or PGM2. Connect the RTX3's RED connector to the relay's RED connector, and the RTX3's PGM connector (PGM1 or PGM2) to the relay's BLK connector.
- Connect PGM3 and PGM4 to external power supplies if additional power is required. A PS25 is recommended. Connect the PGM's N.O. connector to the external power supply's "+" connection. Connect the power supply's "-" connector to the device's "-" connector. Connect the PGM's COM connector to the device's "+" connector.

Write down the serial number of all wireless modules used with the RTX3.

System Reset for EVO Panels

- Press and hold the [0] key.
- Enter the [INSTALLER CODE].
- Enter section [4001].
- Enter the module [SERIAL NUMBER].

System Reset restores the RTX3's factory settings.

LED Feedback

LED	OFF	ON
POWER	OFF	OK (10.5V to 16V)
BUS	No clock or data exchange	Clock and data OK
RF - RX	Not receiving data	Flashes green when receiving data
RF - TX	Not transmitting data	Flashes green when transmitting data

Programming RTX3 for SP Series Panels

When connected to a SP Series control panel, RTX3 settings are programmed through control panel programming sections. For detailed instructions refer to the *SP Series Programming Guide*.

Notes:

- Only one RTX3 module can be connected to a SP Series panel.

Programming for EVO Series Panels

Program RTX3 settings for EVO panels with either a keypad or BabyWare PC software.

Programming RTX3 with a Keypad

When connected to an EVO panel, program RTX3 settings through the keypad by entering Module Programming Mode.

To enter Module Programming mode:

- Press and hold the [0] key.
- Enter the [INSTALLER CODE].
- Enter section [4003].
- Enter the module [SERIAL NUMBER].
- Enter the required [DATA].

After Programming RTX3 for EVO Control Panels

Program the zones, PGMs, sirens and remote controls into the EVO panel. Refer to EVO section [3034] and RTX3 section [001] options [2] and [3] for wireless transmitter supervision options. **Requirement:** Configure all wireless sirens in an EVO system to a single RTX3.

RTX3 Programming Sections for EVO Panels

Section	Feature	Details
[001]	Option	
	[1] Low battery supervision	For RTX3 version 1.5 and higher, this option is always on ON: default
	[2] Check-in supervision	OFF: default
	[3] Check-in supervision time interval	OFF: 24 hours (default) ON: 80 minutes
	[4] RF Jamming supervision	OFF: default
	[5] On-board module tamper supervision	OFF: default
	[6] PGM1 initial state	OFF: Normally Open (default) ON: Normally Closed
	[7] PGM2 initial state	OFF: Normally Open (default) ON: Normally Closed
[8] Transmit tamper signal	OFF: RTX3 ignores tamper signal (default) ON: RTX3 reports tamper signal	
[002]	Remote Control Options	
	[1] REM2 visual and auditory feedback compatibility options*	OFF: Old visual and auditory feedback (Supported by REM2 v2.00 or lower) ON: New visual and auditory feedback (default) Note: Requires REM2 v2.01 and higher
* The new visual and auditory feedback includes the following system status: stay armed, instant armed and exit delay. Other status feedback has not changed. For REM2 v1.04 or older, stay arm, instant arm and exit delay status are not supported, and a rejection beep will be heard when the system is in these status.		
[030]	View Transmitter, Remote Control and PGM Serial Numbers	To view a transmitter's 6-digit serial number: Press and hold the transmitter's anti-tamper switch
[101] to [132]	Assign Wireless Transmitters [101] = Zone Input 1; [132] = Zone Input 32 Enter 6-digit serial number or press and release the transmitter's tamper switch. To delete an assigned transmitter, enter 000000 as the serial number.	
See Details	Remote Controls	To program remotes controls: • Refer to <i>User Code and Remote Control Programming sections in the EVO Programming Guide</i> OR: • Program through BabyWare

Section	Feature	Details
[601] to [632]	Transmitter signal strength	[601] = Zone input 1 [632] = Zone input 32 • 3 or less: weak (move transmitter) • 4 to 10: ok
[701] to [732]	Current battery life	[701] = Zone input 1 [732] = Zone input 32 View number of weeks the batteries have been in the transmitter
[801] to [832]	Previous battery life	[801] = Zone input 1 [832] = Zone input 32 View number of weeks the previous batteries were in the transmitter
[671] to [678]	2WPGM Signal Strength	Sections [671]-[678] correspond to Zone inputs 1 - 8 Signal Strength: • 3 or less: weak (move transmitter) • 4 to 10: ok
[991]	View two-way PGM Tamper Trouble	PGM # in tamper trouble is displayed
[992]	View two-way PGM Supervision Trouble	PGM # in supervision trouble is displayed
[901] to [908]	Assign 2WPGMs	Sections [901]-[908] correspond to Zone inputs 1 - 8 To assign 2WPGMs: Enter a 6-digit serial number or press and release the transmitter's tamper switch To delete an assigned 2WPGM: Enter 000000 as a serial number Note: If a section between [901] to [904] is empty, the RTX3 uses the on board PGM

PGM Programming for EVO

This applies to EVO panels version 6.90 and below.

1. Enter section **[0901] - [0932]**.
2. Enter the 8-digit serial number and 3-digit output number.
3. Enter the 3-digit Event Group, Feature Group, Start # and End # for PGM activation.
4. Enter the 3-digit Event Group, Feature Group, Start #, and End # for PGM deactivation.
5. Define the PGM Delay Value (001 to 255 x 1 sec./min.). Default set to 15 minutes.
6. Set your PGM options, refer to the table below.

OPTION	DESCRIPTION	PGM #	
		OFF	ON
1	PGM deactivation after (OFF = deactivation event; ON = PGM timer)	n	▲
2	PGM base time (OFF = seconds; ON = minutes)	n	▲
3	Flexible PGM deactivation option (OFF = PGM timer only; ON = PGM timer and/or deactivation event)	▲	n
4	PGM initial state (OFF = normally open; ON = normally closed)	▲	n
5	PGM time base (OFF = follow option 2, ON = hour)	▲	n
6 to 8	Future use	-	-

Note: Supervision is not provided to devices connected to the PGM.



PGM Option Programming for EVO

	PGM Activation*			
	Event Group	Feature Group	Start #	End #
PGM1	[910]	[911]	[912]	[913]
PGM2	[920]	[921]	[922]	[923]
PGM3	[930]	[931]	[932]	[933]
PGM4	[940]	[941]	[942]	[943]
PGM5	[950]	[951]	[952]	[953]
PGM6	[960]	[961]	[962]	[963]
PGM7	[970]	[971]	[972]	[973]
PGM8	[980]	[981]	[982]	[983]
Default Data	000	000	000	000

	PGM Deactivation*			
	Event Group	Feature Group	Start #	End #
PGM1	[914]	[915]	[916]	[917]
PGM2	[924]	[925]	[926]	[927]
PGM3	[934]	[935]	[936]	[937]
PGM4	[944]	[945]	[946]	[947]
PGM5	[954]	[955]	[956]	[957]
PGM6	[964]	[965]	[966]	[967]
PGM7	[974]	[975]	[976]	[977]
PGM8	[984]	[985]	[986]	[987]
Default Data	000	000	000	000

	PGM Delay	
	Delay (000 to 255)	Options
PGM1	[918]	[919]
PGM2	[928]	[929]
PGM3	[938]	[939]
PGM4	[948]	[949]
PGM5	[958]	[959]
PGM6	[968]	[969]
PGM7	[978]	[979]
PGM8	[988]	[989]
Default Data	005	OFF

The following options apply to sections **[919], [929]...[989]**:

Option **[1]**: PGM deactivation after, refer to table.

Option **[2]**: PGM Base Time: On = minutes; Off = seconds (default)

Option **[8]**: Flexible PGM deactivation**, refer to table

[1]	[8]	Details
OFF	OFF	Deactivation event
OFF	ON	Deactivation Event
ON	OFF	PGM Timer
ON	ON	PGM Timer or Deactivation event

* For a complete list of events, refer to the PGM programming section of your EVO Programming Guide.

** In order to use the "Flexible PGM deactivation" option **[8]**, the PGM deactivation after option **[1]** must be ON.

Firmware Upgrade

Upgrade RTX3 firmware using a serial connection (307USB). For firmware upgrade instructions see the *Firmware Upgrade Instructions* document at: Paradox.com > Software > BabyWare.

Hardware Compatibility

	EVO	SP Series
Zones	32	32
Remotes	32/999	32
Remote Control Type		REM1 RAC1 REM2 REM3 REM15 REM25
Wireless PGMs	8	16
Wireless Keypads	-	8
Wireless Siren	8	4
Wireless Repeater	-	2

Technical Specifications

Power input voltage	12 Vdc
Frequency	433 or 868 MHz
Sensitivity	-120 dBm
Current consumption	50 mA
Dimensions and weight	15 x 16 x 3 cm (6 x 6 x 1.1 in.) / 24g
Operating temperature	0°C to 49°C (32°F to 120°F)
Humidity	5 - 90%
PGM outputs	PGM1 and PGM2 - 150mA PGM transistor outputs PGM3 - Form C relay output rated at 5A/28Vdc, N.O./N.C. (PGM4 optional)
Range	Refer to the appropriate transmitter instructions
Other	Di-pole antenna; error correction algorithm
Approvals	CE, EN 50131-1 and EN 50131-3, Security Grade 2, Environmental Class II

FCC and Industry Canada Compliance Statement

This device complies with FCC Rules Part 15 and with Industry Canada license exempt RSS standard(s). Operation is subject to two conditions:

1. This device may not cause harmful interference
2. This device must accept any interference that may be received or that may cause undesired operation.

Le présent appareil est conforme aux CNR d'Industrie Canada applicables aux appareils radio exempts de licence. L'exploitation est autorisée aux deux conditions suivantes :

1. l'appareil ne doit pas produire de brouillage, et
2. l'utilisateur de l'appareil doit accepter tout brouillage radioélectrique subi, même si le brouillage est susceptible d'en compromettre le fonctionnement.

This Class B digital apparatus complies with Canadian ICES-003.

Cet appareil numérique de la classe B est conforme à la norme NMB-003 du Canada.

FCC ID: KDVRTX3

IC: 2438A-RTX3

FCC WARNING

This equipment has been tested and found to comply with the limits for a Class B digital device, pursuant to Part 15 of the FCC Rules. These limits are designed to provide reasonable protection against harmful interference in a residential installation.

This equipment generates, uses and can radiate radio frequency energy and, if not installed and used in accordance with the instructions, may cause harmful interference to radio communications. However, there is no guarantee that interference will not occur in a particular installation. If this equipment does cause harmful interference to radio or television reception, which can be determined by turning the equipment off and on, the user is encouraged to try to correct the interference by one or more of the following measures:

- Reorient or relocate the receiving antenna.
- Increase the separation between the equipment and the receiver.
- Connect the equipment into an outlet different from that to which the receiver is connected.
- Consult the dealer or an experienced radio/TV technician for help.

Changes or modifications to this equipment not expressly approved by the party responsible for compliance (Paradox Security Systems Ltd.) could void the user's authority to operate the equipment.

Warranty

For complete warranty information on this product, please refer to the Limited Warranty Statement which can be found on paradox.com/terms or contact your local distributor.

Patents

US, Canadian and international patents may apply. Paradox is a trademark or registered trademark of Paradox Security Systems (Bahamas) Ltd.

©2020 Paradox Security Systems (Bahamas) Ltd. All rights reserved. Specifications may change without prior notice.



Specifications DFMSC03/CO/TOP

The DFMSC03/CO/TOP is the siren cover kit.

This siren cover kit comes with:

- UV treated plastic cover
- Combo Siren/Horn, 8 Ω /15W
- LED Strobe (Water-proof), 50mA
- Reed tamper switch
- Top hat piezo, 90mA @ 105dB
- 7-Way terminal block (pre-wired)

Total current draw for DFMSC03/CO/TOP is 590mA.

Operating voltage is 12VDC.

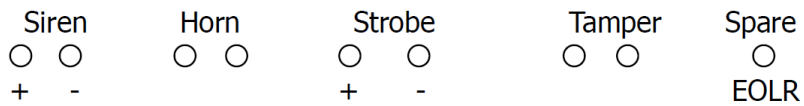



VRLA 12V7AH

SA12V7

Specifications

Nominal Voltage	12 V	
Nominal Capacity 20HR	7.0 AH	
Dimensions	Length	151±1mm (5.94 inches)
	Width	65±1mm (2.56 inches)
	Container Height	95±1mm (3.74 inches)
	Total Height (with terminal)	100±1mm (3.94 inches)
Approx Weight	Approx 2.10 kg (4.63 lbs)	
Terminal	F1	
Container Material	ABS Plastic	
Lead Material	Purity Lead 99.995%	
Sulfuric Acid	Distilled Sulfuric Acid (Zero metal content)	
Separator	AGM	
Rated Capacity	7.00 AH/0.350A	(20hr, 1.80V/cell, 25°C/77°F)
	6.53 AH/0.653A	(10hr, 1.80V/cell, 25°C/77°F)
	6.00 AH/1.20A	(5hr, 1.75V/cell, 25°C/77°F)
	5.37 AH/1.79A	(3hr, 1.75V/cell, 25°C/77°F)
	4.55 AH/4.55A	(1hr, 1.60V/cell, 25°C/77°F)
Max. Discharge Current	105A (5s)	
Internal Resistance	Approx 23mΩ	
Operating Temp.Range	Discharge	: -15 - 50°C (5 - 122°F)
	Charge	: 0 - 40°C (32 - 104°F)
	Storage	: -15 - 40°C (5 - 104°F)
Nominal Operating Temp.Range	25±3°C (77±5°F)	
Cycle Use	Initial Charging Current less than 2.1A. Voltage 14.4V - 14.7V at 25°C (77°F) Temp.Coefficient -30mV/°C	
Standby Use	No limit on Initial Charging Current Voltage 13.5V - 13.8V at 25°C (77°F) Temp.Coefficient -20 mV/°C	
Capacity affected by Temperature	40°C (104°F) 103% 25°C (77°F) 100% 0°C (32°F) 86%	
Self Discharge	Sentry AGM series batteries may be stored for up to 6 months at 25°C (77°F) and then a freshening charge is required. For higher temperatures the time interval will be shorter.	



Applications

- All purpose
- Standby Applications
- Recreation Vehicles
- Uninterruptible Power Supply (UPS)
- Electric Power System (EPS)
- Fire & Security
- Generators
- Medical Equipment

Dimensions

F1 Terminal

Unit: mm (inches)

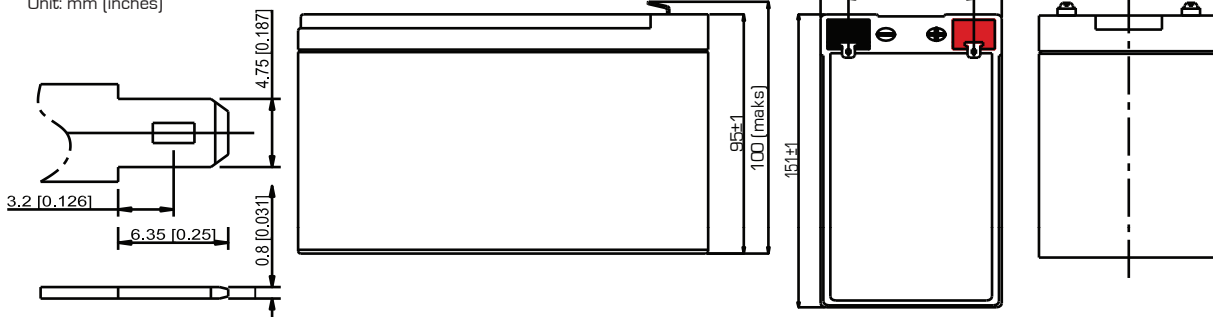

Constant Current Discharge (Amperes) at 25°C (77°F)

F.V./Time	5min	10min	15min	20min	30min	45min	1h	2h	3h	4h	5h	6h	8h	10h	20h
1.85V/cell	18.0	12.8	10.48	8.79	6.53	4.79	3.86	2.29	1.69	1.36	1.14	0.98	0.774	0.640	0.345
1.80V/cell	21.4	14.3	11.4	9.44	6.94	5.05	4.03	2.38	1.74	1.40	1.17	1.01	0.791	0.653	0.350
1.75V/cell	24.2	15.6	12.2	10.0	7.29	5.27	4.18	2.45	1.79	1.43	1.20	1.03	0.805	0.663	0.357
1.70V/cell	26.7	16.7	12.9	10.5	7.59	5.46	4.32	2.51	1.83	1.46	1.22	1.05	0.817	0.672	0.361
1.65V/cell	28.8	17.7	13.5	10.9	7.86	5.62	4.46	2.57	1.86	1.48	1.23	1.06	0.826	0.680	0.365
1.60V/cell	30.6	18.6	14.1	11.3	8.09	5.76	4.55	2.61	1.89	1.50	1.25	1.07	0.834	0.685	0.367

Constant Power Discharge (Watts/Cell) at 25°C (77°F)

F.V./Time	5min	10min	15min	20min	30min	45min	1h	2h	3h	4h	5h	6h	8h	10h	20h
1.85V/cell	34.2	24.5	20.2	17.1	12.8	9.44	7.64	4.56	3.37	2.72	2.29	1.99	1.565	1.296	0.701
1.80V/cell	40.2	27.2	21.9	18.3	13.5	9.91	7.96	4.72	3.47	2.79	2.34	2.03	1.593	1.318	0.708
1.75V/cell	45.1	29.5	23.3	19.3	14.2	10.3	8.23	4.85	3.55	2.85	2.39	2.06	1.616	1.344	0.719
1.70V/cell	49.2	31.3	24.5	20.1	14.7	10.6	8.48	4.96	3.62	2.89	2.42	2.09	1.633	1.347	0.725
1.65V/cell	52.6	32.9	25.5	20.8	15.2	10.9	8.73	5.05	3.68	2.93	2.45	2.11	1.649	1.359	0.731
1.60V/cell	55.5	34.3	26.3	21.5	15.5	11.2	8.88	5.12	3.72	2.96	2.47	2.13	1.660	1.367	0.734

Discharge Characteristics

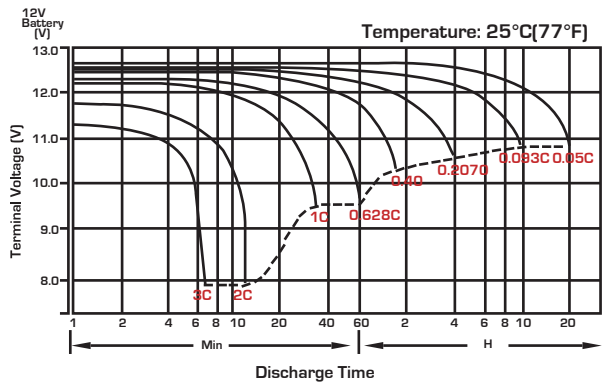

Float Charging Characteristics

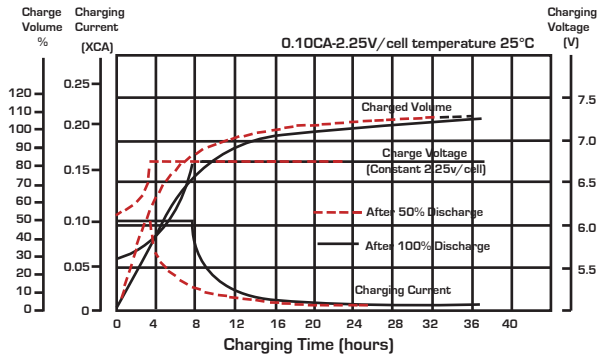

Temperature Effects in Relation to Battery Capacity

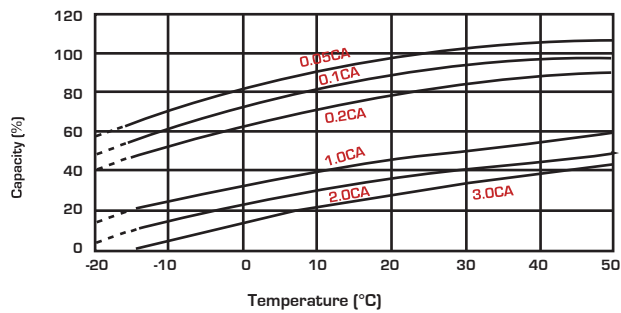

Effect of Temperature on Long Term Float Life

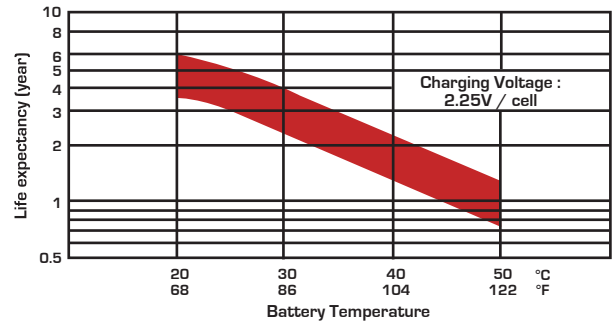

Cycle Life in Relation to Depth of Discharge

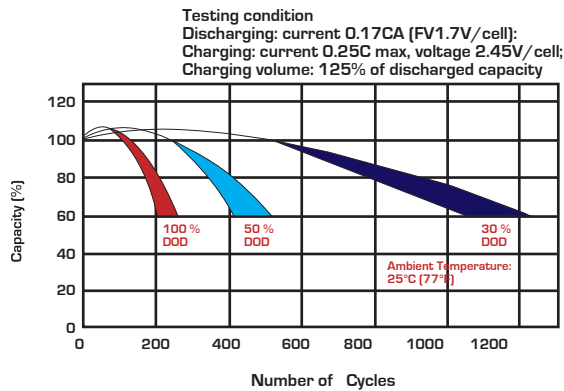

Self Discharge Characteristics

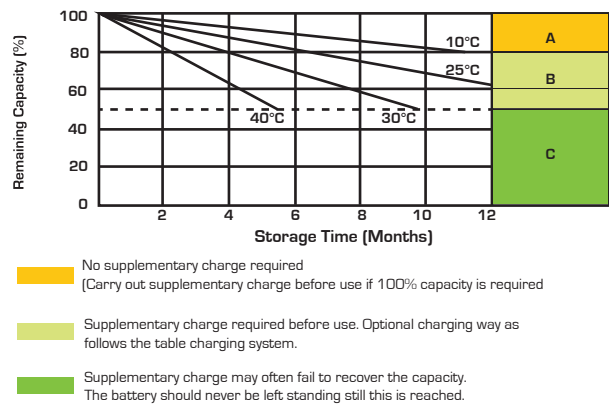

Charging System

DOD	Current Limit (A)	Constant Voltage (V)	Fully Charged Time (h)
20	0.15C ₁₀	13.5-13.8 vpc (12V)	10
	0.20C ₁₀	6.75-6.9 vpc (6V)	8
50	0.15C ₁₀	13.5-13.8 vpc (12V)	15
	0.20C ₁₀	6.75-6.9 vpc (6V)	12
80	0.15C ₁₀	13.5-13.8 vpc (12V)	16
	0.20C ₁₀	6.75-6.9 vpc (6V)	14
100	0.15C ₁₀	13.5-13.8 vpc (12V)	20
	0.20C ₁₀	6.75-6.9 vpc (6V)	18

State of Charge (SOC)

Open Circuit Voltage (V/cell)	Open Circuit Voltage (12V/cell)	Open Circuit Voltage (6V/cell)	State of Charge (% of full charge capacity)
2.14-2.15	12.84-12.90	6.42-6.46	100
2.12-2.13	12.72-12.78	6.36-6.39	90
2.11	12.66	6.33	80
2.09	12.54	6.27	70
2.07	12.42	6.21	60
2.05	12.30	6.15	50



Sealed Performance Batteries

Domestic Sales | Ph: +61 (0)7 3386 1102 | Fax: +61 (0)7 3102 9913

sales@spb.net.au | www.sealedperformance.com.au

National Warehouse | 1 Ant Road | Yatala, Brisbane QLD 4207

Melbourne Office | 2/9 Compark Circuit | Mulgrave, Melbourne VIC 3170

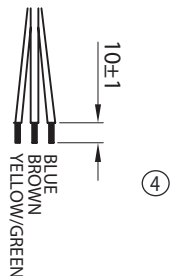

④

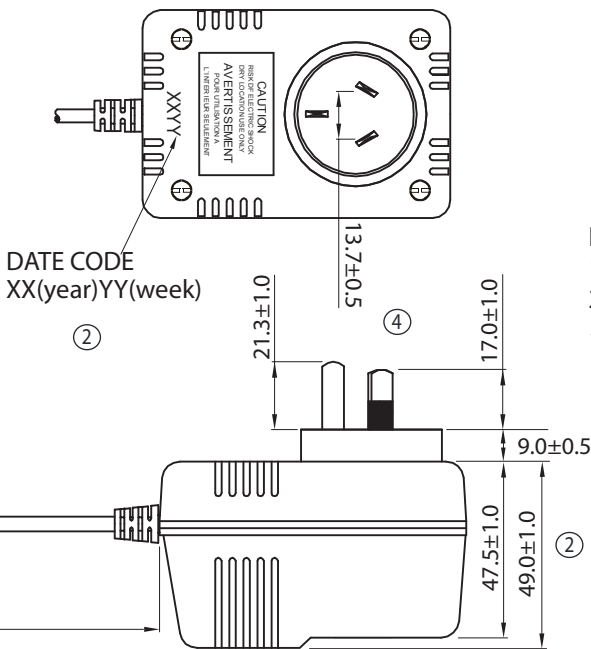

DATE CODE
XX(year)YY(week)

②

④

NOTES:

1. OUTPUT CORD: 20AWGX3C 1.83M Lead Free GREY (RAL7035)
2. CASE: GREY (RAL7035)
3. SECURITY SCREW IS AN ESSENTIAL REQUIREMENT, BOTH "⊥" AND "△" SHAPE ARE ACCEPTABLE

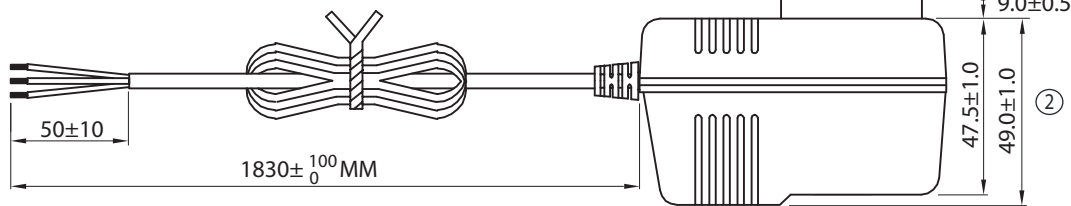

②

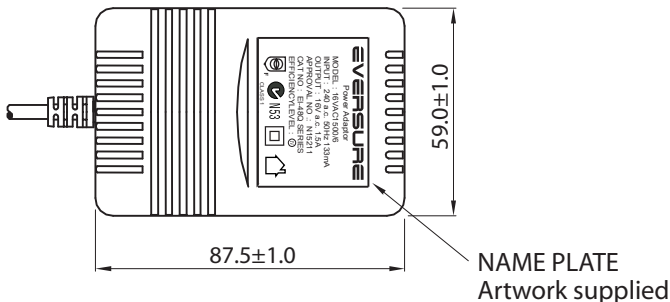

NAME PLATE
Artwork supplied

	REVISED	DRAWN	APPROVED
①	AMENDED PACKING QTY AND CARTON SIZE	JACKY 10/08/09	GARY 10/08/09
②	ADDED DATE CODE ON CASE AND DIMENSIONS	JACKY 07/12/09	GARY 07/12/09
③	ADDED PASSED LABEL ON CARTON	TODD 22/12/10	JACKY 22/12/10
④	AMENDED AC PINS DIMENSION & ADDED WIRES COLORS	ANLEI 01/11/12	ANLEI 01/11/12
⑤	CHANGED CROSS SHAPPED SCREW TO SHAPE ⊥ SCREW ON CASE	MARK 31/08/15	FREDERICK 31/08/15

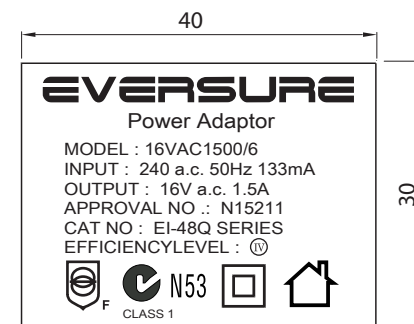

LABEL ARTWORK
Black word on Silver base label

TE DRAWING NO: TE40-0001 R5					PART NO: 16VAC1500MPS/6					
DESCRIPTION: AC ADAPTOR EI-48Q, 16VAC1500mA, 3 WIRE - MEPS										
SIZE	A4	DATE	30/04/09	CHECKED	KEVIN 30/04/09		ORDER REF:	0420	SHEET 1 OF 3	TOLERANCES UNLESS OTHERWISE STATED X.= +/- .X.= +/-0.5 .XX.= +/-0.2
UNIT	MM	DRAWN	KEVIN	APPROVED	FRANK 30/04/09		CUSTOMER: TE			
SCALE	NTS	MANU:				DATE:				



THIS DRAWING AND SPECIFICATIONS ARE THE PROPERTY OF TELEPHONE EQUIPMENT (NSW) Pty Ltd AND SHALL NOT BE REPRODUCED OR USED IN ANY MANNER WITHOUT THE PRIOR WRITTEN CONSENT OF TELEPHONE EQUIPMENT (NSW) Pty Ltd

ITEM	SPECIFICATION	
1. Primary rated input voltage	AC240V 50Hz 133mA	
2. Secondary rated output voltage and current	Unloaded voltage: AC 18 V ± 5% Loaded Voltage : AC 16 V ± 5% AT 1500 mA	
3. Ripple voltage	*** mV (RMS) MAX. AT Rated Loading	
4. Insulation resistance	Primary - secondary: DC 500 V 100 MΩ Min	
5. Dielectric withstand test	Primary - secondary: AC 3.64 KV 1 seconds	
6. Temperature rise	At rated loading 90°C max. For input coil (By resistance method) and 55°C max. on case surface (By use of thermometer)	
7. EFFICIENCY	≥ 79%	
8. Leadout	Primary	SAA PLUG IN TYPE
	Secondary	PVC cable length: 1.8 Meter Colour : GREY (RAL7035) Wire size: AWG#20/3C Plug : STRIPPED AND TINNED
9. Test circuit	<p>The diagram shows a transformer with a thermal fuse on the primary side. The secondary side is connected to a load circuit containing an ammeter (A), a voltmeter (V), and a variable load resistor.</p>	
10. Case	SAA48 colour = GREY (RAL7035)	

	REVISED	DRAWN	APPROVED
①	AMENDED PACKING QTY AND CARTON SIZE	JACKY 10/08/09	GARY 10/08/09
②	ADDED DATE CODE ON CASE AND DIMENSIONS	JACKY 07/12/09	GARY 07/12/09
③	ADDED PASSED LABEL ON CARTON	TODD 22/12/10	JACKY 22/12/10
④	AMENDED AC PINS DIMENSION & ADDED WIRES COLORS	ANLEI 01/11/12	ANLEI 01/11/12
⑤	CHANGED CROSS-SHAPED SCREW TO SHAPE SCREW ON CASE	MARK 31/08/15	FREDERICK 31/08/15

TE DRAWING NO: TE40-0001 R5

PART NO: 16VAC1500MPS/6

DESCRIPTION: AC ADAPTOR EI-48Q,16VAC1500mA, 3 WIRE - MEPS



THIS DRAWING AND SPECIFICATIONS ARE THE PROPERTY OF TELEPHONE EQUIPMENT (NSW) Pty Ltd AND SHALL NOT BE REPRODUCED OR USED IN ANY MANNER WITHOUT THE PRIOR WRITTEN CONSENT OF TELEPHONE EQUIPMENT (NSW) Pty Ltd

SIZE	A4	DATE	30/04/09	CHECKED	KEVIN 30/04/09		ORDER REF:	0420	SHEET 2 OF 3	TOLERANCES UNLESS OTHERWISE STATED X.= +/- .X= +/-0.5 .XX= +/-0.2
UNIT	MM	DRAWN	KEVIN	APPROVED	FRANK 30/04/09		CUSTOMER:	TE		
SCALE	NTS	MANU:				DATE:				

	REVISED	DRAWN	APPROVED
①	AMENDED PACKING QTY AND CARTON SIZE	JACKY 10/08/09	GARY 10/08/09
②	ADDED DATE CODE ON CASE AND DIMENSIONS	JACKY 07/12/09	GARY 07/12/09
③	ADDED PASSED LABEL ON CARTON	TODD 22/12/10	JACKY 22/12/10
④	AMENDED AC PINS DIMENSION & ADDED WIRES COLORS	ANLEI 01/11/12	ANLEI 01/11/12
⑤	CHANGED CROSS-SHAPPED SCREW TO SHAPE  SCREW ON CASE	MARK 31/08/15	FREDERICK 31/08/15

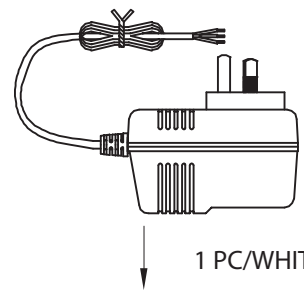

1 PC/WHITE BOX

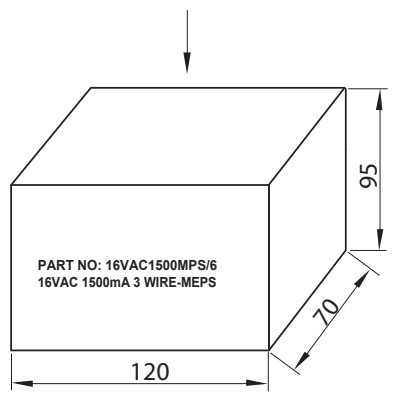
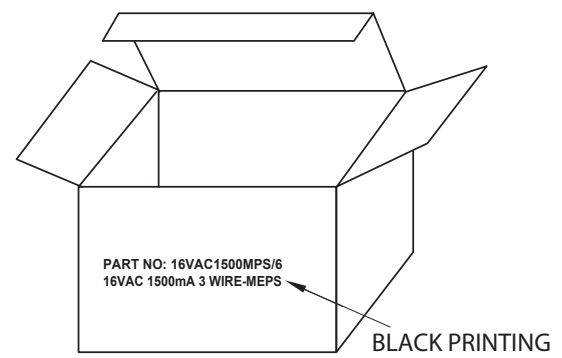

20 BOXES/CARTON ①

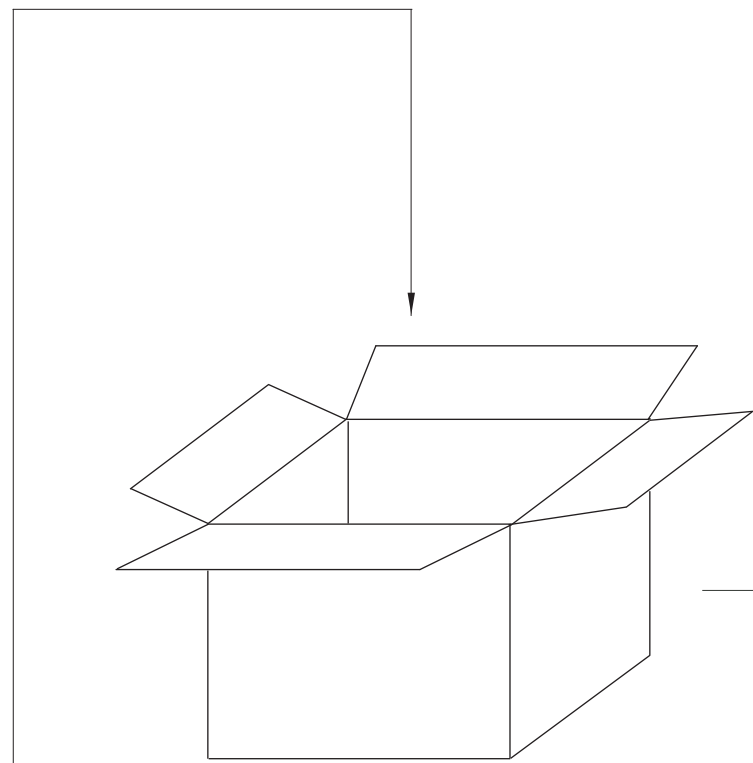

SHIPPING CARTON
PLEASE FOLLOW ORDER TO PRINT SHIPPING MARKS.

ADHESIVE TAPE

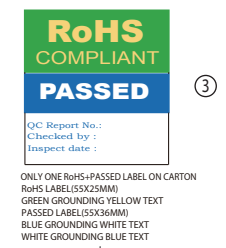
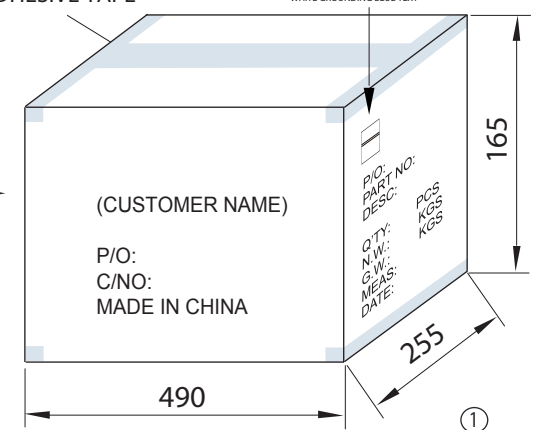

TE DRAWING NO: TE40-0001 R5 PART NO: 16VAC1500MPS/6

DESCRIPTION: AC ADAPTOR EI-48Q,16VAC1500mA, 3 WIRE - MEPS



THIS DRAWING AND SPECIFICATIONS ARE THE PROPERTY OF TELEPHONE EQUIPMENT (NSW) Pty Ltd AND SHALL NOT BE REPRODUCED OR USED IN ANY MANNER WITHOUT THE PRIOR WRITTEN CONSENT OF TELEPHONE EQUIPMENT (NSW) Pty Ltd

SIZE	A4	DATE	30/04/09	CHECKED	KEVIN 30/04/09		ORDER REF:	0420	SHEET 3 OF 3	TOLERANCES UNLESS OTHERWISE STATED X.= +/-1 .X.= +/-0.5 .XX.= +/-0.2
UNIT	MM	DRAWN	KEVIN	APPROVED	FRANK 30/04/09		CUSTOMER:	TE		
SCALE	NTS	MANU:					DATE:			



Specifications TELLC0280

The TELLC0280 is the telephone lead with 606 Socket and 2 Meter length of Telephone Cord.

Colour: Ivory.

