



Specifications PRXMG5050+-V74

The PRXMG5050+-V74 is a Magellan 32-Zone Wireless Transceiver Control Panel.

Features:

- 2 serial outputs master/slave
- M2 two-way FSK hardware ready
- 8 on-board zones (16 with ATZ)
- Built-in transceiver (433 MHz)
- Expandable to 32 zones, 2 partitions, 32 users and 32 remotes
- 4-wire communication bus (connect up to 15 modules)
- Supports IP and cellular IP reporting
- Supports 16 PGMs (any of which can be wireless)
- App-based system control via BlueEye
- In-field firmware upgrade via 307USB And BabyWare remote or local
- Menu-driven programming for the Installer, Master and Maintenance codes
- Multiple telephone numbers for event reporting: 3 monitoring and 5 for Personal Dialing
- Calendar with Daylight savings Time
- StayD Mode
- Sleep arming method
- RF Jamming Supervision
- 512 events buffered.

P ▲ R ▲ D O X™



Specifications **PRX278000033-P2C**

The PRX278000033-P2C is a metal box enclosure for provision multiple module and panel mounting.

Features:

- Many punch-out holes for simple wiring
- Easy door removal
- Sizes: 28cm X 28cm X 7.6cm (11" x11" x 3")

P ▲ R ▲ D O X™



Specifications PRXK-TK278

The PRXK-TK278 is a BOM Kit for 1x tamper switch PRX2502302000-P2C and 1x tamper bracket PRX2781030000-P2C to suit with Paradox Metal Box Enclosure PRX2780000033-P2C; to protects against tampering (opening door or removal from wall).

P ▲ R ▲ D O X™

SP5500+ / SP6000+ / SP7000+ User Guide

4 to 32-Zone Expandable Security Systems



P ▲ R ▲ D O X™

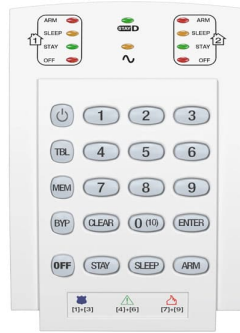

Specifications PRXK10V-N3Q

The PRXK10V-N3Q is a 10-Zone Hardwired LED Keypad Module (Vertical).

Features:

- Supports StayD Mode
- 10-zone LED display
- Separate Arm, Sleep, Stay and Off LEDs per partition
- Patented Key Light display (button lights up to indicate an open zone)
- 1 keypad zone input
- Independently set chime zones
- 7 one-touch action buttons
- 3 keypad-activated panic alarms
- Adjustable backlight
- Connects to 4-wire communication bus
- Compatible with MG5000, MG5050, MG5075, and Spectra SP series

P ▲ R ▲ D O X™

MAGELLAN™

K10V/H - User's Quick Reference Guide

KEYPAD OVERVIEW

Partition 1 Status Partition 2 Status

Arm (red), Sleep (yel), Stay (grn):
On = Partition armed
Off = Partition disarmed
Flash = Exit Delay
Fast Flash* = Exit Delay (final 10 sec.)
Fast Flash* = Partition in alarm

* Audible Indicators:
Continuous beep = Alarm
Variable beep = Fire alarm
Intermittent beep = Beginning of exit delay
Fast beep = Final 10 sec. of exit delay

 = Press once + [MASTER CODE] for Quick Menu Programming

On = StayD Mode Enabled

Off Light (red):
On = Disarmed
Off = System armed

AC Light
On = Power on
Off = Power off

Zone Display:
Keys [1] to [0(10)] correspond to zones 1 to 10 respectively.
Key Lit: Open or entry delay
Key Flash: In alarm

[TBL] Trouble display
On = Trouble(s) occurring

[MEM] Alarm memory display
On = Alarm(s) occurred

[BYP] Bypass programming
On = Zone(s) bypassed

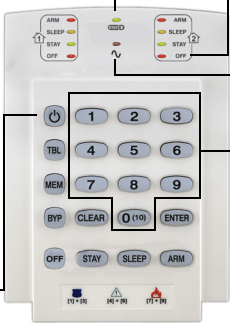

ARMING AND DISARMING

**TO ARM
WHEN LEAVING...**



**TO ARM
WHEN STAYING...**



To Regular Arm:

1. Close all zones in the desired partition.
2. Press [ARM].
3. Enter your [ACCESS CODE]*.

To Stay Arm:

1. Press the [STAY] key.
2. Enter your [ACCESS CODE]*.

To Sleep Arm:

1. Press the [SLEEP] key.
2. Enter your [ACCESS CODE]*.

To Disarm:
[OFF] + [ACCESS CODE]*

* If needed, press button(s) corresponding to desired partition(s). For two partitions, press the other key after the confirmation beep.



PANIC ALARMS

To send a silent or audible alarm to your Security Company, press and hold one of the button combinations listed for 3 seconds.

Panic Alarm Type	Button Combinations
Police	Press [1] & [3]
Medical	Press [4] & [6]
Fire	Press [7] & [9]

TROUBLE DISPLAY

When a trouble condition occurs, the **[TBL]** key will illuminate.

1. Press the **[TBL]** key. The key will flash and number(s) corresponding to the trouble(s) will illuminate.
2. Read the corresponding explanation from the trouble list in the MG5000 User Guide.
3. Press the **[CLEAR]** key to exit.

BYPASS PROGRAMMING

Bypassed zones remained unarmed when the partition is armed.

1. Press the **[BYP]** key.
2. Enter your **[ACCESS CODE]***.
3. The corresponding key of all open zones will illuminate. Select the zone(s) you want to bypass by entering the one-digit zone number. The zone key will flash.
4. Press the **[ENTER]** key to save and exit.

ALARM MEMORY DISPLAY

To view the alarms that occurred during the last armed period:

1. Disarm the system.
2. Press the **[MEM]** key.
3. The corresponding zone numbers that were in alarm the last time the system was armed will illuminate.
4. Press the **[CLEAR]** key to exit.

KEYPAD SETTINGS

To mute the keypad:

Press and hold the **[CLEAR]** key for 6 seconds to enable or disable Keypad Muting.

To modify the backlight:

1. Press and hold the **[MEM]** key for 3 seconds.
2. The **[MEM]** key will illuminate.
3. Press the **[MEM]** key to set the desired backlight level.
4. Press **[CLEAR]** or **[ENTER]** to exit.

CHIME PROGRAMMING

A Chime Enabled zone will advise you every time it is opened by causing your keypad to beep.

1. Press & hold the corresponding zone key for 3 seconds (Accept beep = Chime enabled, Fail beep = Chime disabled).

© Paradox Security Systems Ltd., 2005-2015.
Magellan is a trademark or registered trademark of Paradox Security Systems (Bahamas) Ltd. and its affiliates in Canada, the United States and/or other countries. All rights reserved.

P ▲ R ▲ D O X™

PARADOX.COM

Printed in Canada 11/2015

K10VH-EQ04



VRLA 12V7AH

SA12V7

Specifications

Nominal Voltage	12 V	
Nominal Capacity 20HR	7.0 AH	
Dimensions	Length	151±1mm (5.94 inches)
	Width	65±1mm (2.56 inches)
	Container Height	95±1mm (3.74 inches)
	Total Height (with terminal)	100±1mm (3.94 inches)
Approx Weight	Approx 2.10 kg (4.63 lbs)	
Terminal	F1	
Container Material	ABS Plastic	
Lead Material	Purity Lead 99.995%	
Sulfuric Acid	Distilled Sulfuric Acid (Zero metal content)	
Separator	AGM	
Rated Capacity	7.00 AH/0.350A	(20hr, 1.80V/cell, 25°C/77°F)
	6.53 AH/0.653A	(10hr, 1.80V/cell, 25°C/77°F)
	6.00 AH/1.20A	(5hr, 1.75V/cell, 25°C/77°F)
	5.37 AH/1.79A	(3hr, 1.75V/cell, 25°C/77°F)
	4.55 AH/4.55A	(1hr, 1.60V/cell, 25°C/77°F)
Max. Discharge Current	105A (5s)	
Internal Resistance	Approx 23mΩ	
Operating Temp.Range	Discharge	: -15 - 50°C (5 - 122°F)
	Charge	: 0 - 40°C (32 - 104°F)
	Storage	: -15 - 40°C (5 - 104°F)
Nominal Operating Temp.Range	25±3°C (77±5°F)	
Cycle Use	Initial Charging Current less than 2.1A. Voltage 14.4V - 14.7V at 25°C (77°F) Temp.Coefficient -30mV/°C	
Standby Use	No limit on Initial Charging Current Voltage 13.5V - 13.8V at 25°C (77°F) Temp.Coefficient -20 mV/°C	
Capacity affected by Temperature	40°C (104°F) 103% 25°C (77°F) 100% 0°C (32°F) 86%	
Self Discharge	Sentry AGM series batteries may be stored for up to 6 months at 25°C (77°F) and then a freshening charge is required. For higher temperatures the time interval will be shorter.	



Applications

- All purpose
- Standby Applications
- Recreation Vehicles
- Uninterruptible Power Supply (UPS)
- Electric Power System (EPS)
- Fire & Security
- Generators
- Medical Equipment

Dimensions

F1 Terminal

Unit: mm (inches)

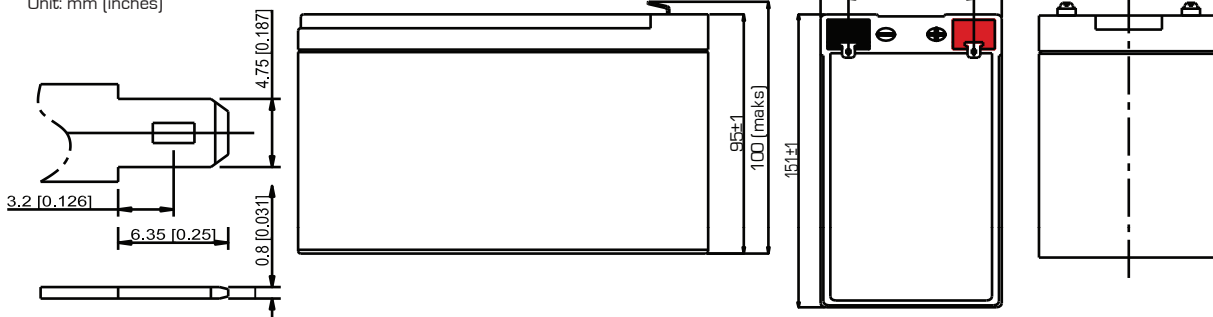

Constant Current Discharge (Amperes) at 25°C (77°F)

F.V./Time	5min	10min	15min	20min	30min	45min	1h	2h	3h	4h	5h	6h	8h	10h	20h
1.85V/cell	18.0	12.8	10.48	8.79	6.53	4.79	3.86	2.29	1.69	1.36	1.14	0.98	0.774	0.640	0.345
1.80V/cell	21.4	14.3	11.4	9.44	6.94	5.05	4.03	2.38	1.74	1.40	1.17	1.01	0.791	0.653	0.350
1.75V/cell	24.2	15.6	12.2	10.0	7.29	5.27	4.18	2.45	1.79	1.43	1.20	1.03	0.805	0.663	0.357
1.70V/cell	26.7	16.7	12.9	10.5	7.59	5.46	4.32	2.51	1.83	1.46	1.22	1.05	0.817	0.672	0.361
1.65V/cell	28.8	17.7	13.5	10.9	7.86	5.62	4.46	2.57	1.86	1.48	1.23	1.06	0.826	0.680	0.365
1.60V/cell	30.6	18.6	14.1	11.3	8.09	5.76	4.55	2.61	1.89	1.50	1.25	1.07	0.834	0.685	0.367

Constant Power Discharge (Watts/Cell) at 25°C (77°F)

F.V./Time	5min	10min	15min	20min	30min	45min	1h	2h	3h	4h	5h	6h	8h	10h	20h
1.85V/cell	34.2	24.5	20.2	17.1	12.8	9.44	7.64	4.56	3.37	2.72	2.29	1.99	1.565	1.296	0.701
1.80V/cell	40.2	27.2	21.9	18.3	13.5	9.91	7.96	4.72	3.47	2.79	2.34	2.03	1.593	1.318	0.708
1.75V/cell	45.1	29.5	23.3	19.3	14.2	10.3	8.23	4.85	3.55	2.85	2.39	2.06	1.616	1.344	0.719
1.70V/cell	49.2	31.3	24.5	20.1	14.7	10.6	8.48	4.96	3.62	2.89	2.42	2.09	1.633	1.347	0.725
1.65V/cell	52.6	32.9	25.5	20.8	15.2	10.9	8.73	5.05	3.68	2.93	2.45	2.11	1.649	1.359	0.731
1.60V/cell	55.5	34.3	26.3	21.5	15.5	11.2	8.88	5.12	3.72	2.96	2.47	2.13	1.660	1.367	0.734

Discharge Characteristics

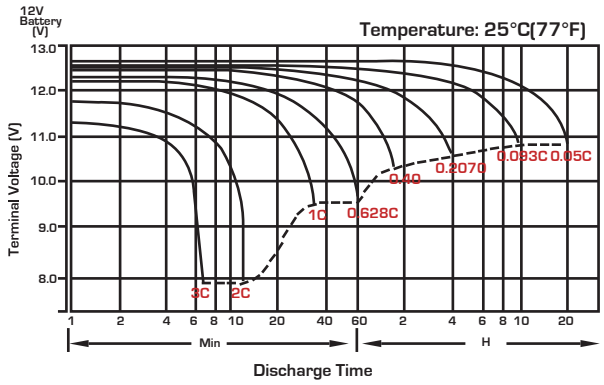

Float Charging Characteristics

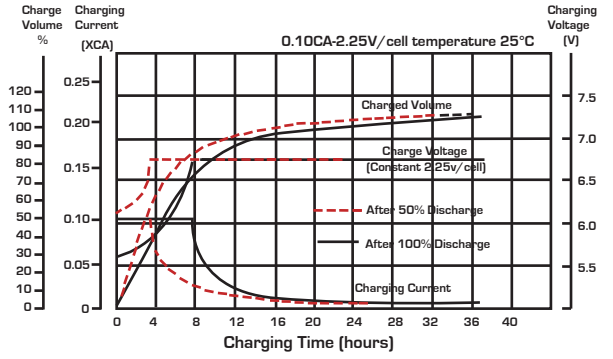

Temperature Effects in Relation to Battery Capacity

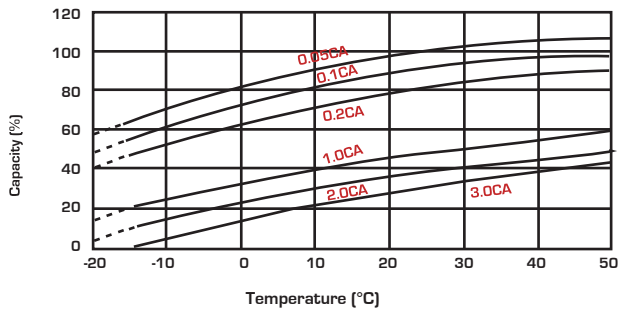

Effect of Temperature on Long Term Float Life

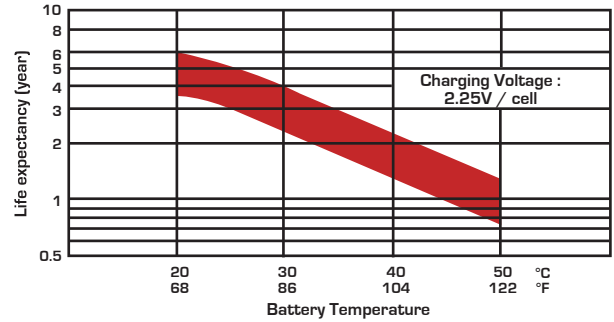

Cycle Life in Relation to Depth of Discharge

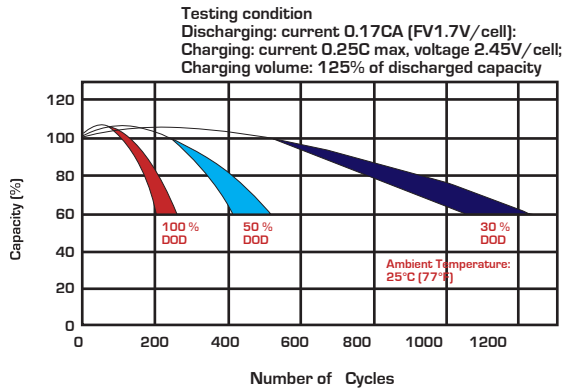

Self Discharge Characteristics

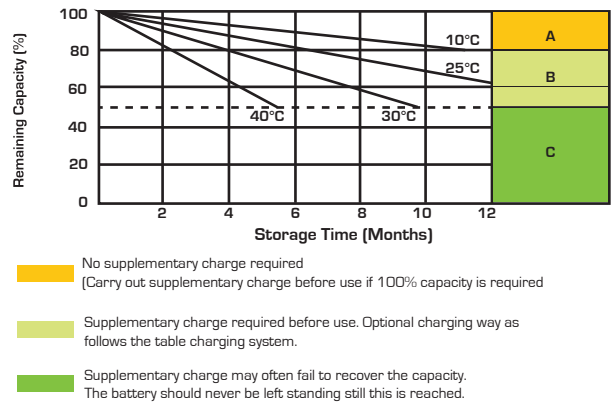

Charging System

DOD	Current Limit (A)	Constant Voltage (V)	Fully Charged Time (h)
20	0.15C ₁₀	13.5-13.8 vpc (12V)	10
	0.20C ₁₀	6.75-6.9 vpc (6V)	8
50	0.15C ₁₀	13.5-13.8 vpc (12V)	15
	0.20C ₁₀	6.75-6.9 vpc (6V)	12
80	0.15C ₁₀	13.5-13.8 vpc (12V)	16
	0.20C ₁₀	6.75-6.9 vpc (6V)	14
100	0.15C ₁₀	13.5-13.8 vpc (12V)	20
	0.20C ₁₀	6.75-6.9 vpc (6V)	18

State of Charge (SOC)

Open Circuit Voltage (V/cell)	Open Circuit Voltage (12V/cell)	Open Circuit Voltage (6V/cell)	State of Charge (% of full charge capacity)
2.14-2.15	12.84-12.90	6.42-6.46	100
2.12-2.13	12.72-12.78	6.36-6.39	90
2.11	12.66	6.33	80
2.09	12.54	6.27	70
2.07	12.42	6.21	60
2.05	12.30	6.15	50



Sealed Performance Batteries

Domestic Sales | Ph: +61 (0)7 3386 1102 | Fax: +61 (0)7 3102 9913
 sales@spb.net.au | www.sealedperformance.com.au
 National Warehouse | 1 Ant Road | Yatala, Brisbane QLD 4207
 Melbourne Office | 2/9 Compark Circuit | Mulgrave, Melbourne VIC 3170

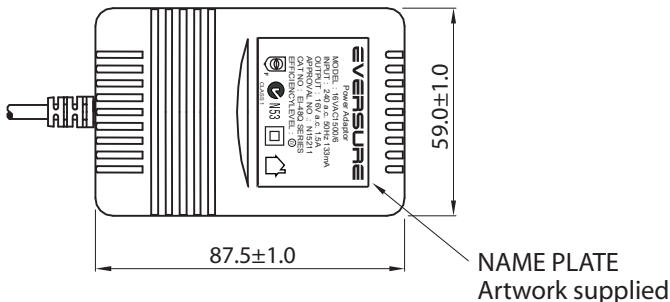
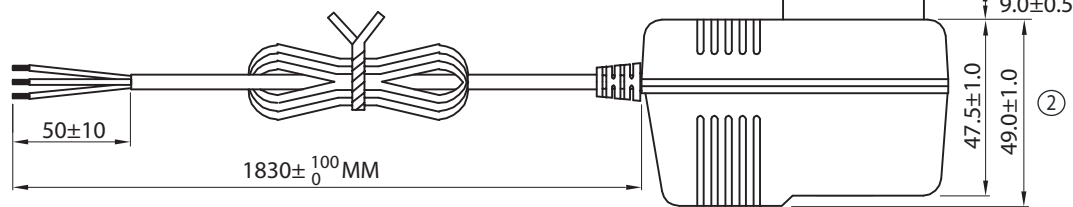
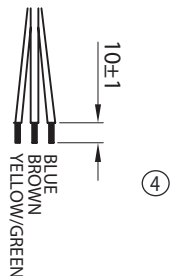

	REVISED	DRAWN	APPROVED
①	AMENDED PACKING QTY AND CARTON SIZE	JACKY 10/08/09	GARY 10/08/09
②	ADDED DATE CODE ON CASE AND DIMENSIONS	JACKY 07/12/09	GARY 07/12/09
③	ADDED PASSED LABEL ON CARTON	TODD 22/12/10	JACKY 22/12/10
④	AMENDED AC PINS DIMENSION & ADDED WIRES COLORS	ANLEI 01/11/12	ANLEI 01/11/12
⑤	CHANGED CROSS-SHAPED SCREW TO SHAPE SCREW ON CASE	MARK 31/08/15	FREDERICK 31/08/15

- NOTES:
1. OUTPUT CORD: 20AWGX3C 1.83M Lead Free GREY (RAL7035)
 2. CASE: GREY (RAL7035)
 3. SECURITY SCREW IS AN ESSENTIAL REQUIREMENT, BOTH "" AND "" SHAPE ARE ACCEPTABLE

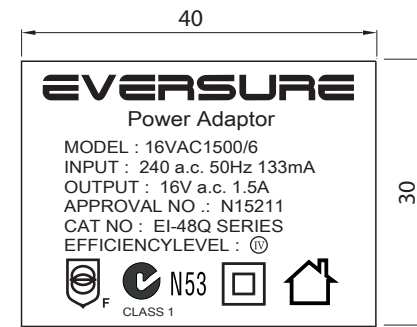

LABEL ARTWORK
Black word on Silver base label

TE DRAWING NO: TE40-0001 R5					PART NO: 16VAC1500MPS/6					
DESCRIPTION: AC ADAPTOR EI-48Q, 16VAC1500mA, 3 WIRE - MEPS										
SIZE	A4	DATE	30/04/09	CHECKED	KEVIN 30/04/09		ORDER REF:	0420	SHEET 1 OF 3	TOLERANCES UNLESS OTHERWISE STATED X.= +/- .X.= +/-0.5 .XX.= +/-0.2
UNIT	MM	DRAWN	KEVIN	APPROVED	FRANK 30/04/09		CUSTOMER:	TE		
SCALE	NTS	MANU:				DATE:				



THIS DRAWING AND SPECIFICATIONS ARE THE PROPERTY OF TELEPHONE EQUIPMENT (NSW) Pty Ltd AND SHALL NOT BE REPRODUCED OR USED IN ANY MANNER WITHOUT THE PRIOR WRITTEN CONSENT OF TELEPHONE EQUIPMENT (NSW) Pty Ltd

ITEM	SPECIFICATION	
1. Primary rated input voltage	AC240V 50Hz 133mA	
2. Secondary rated output voltage and current	Unloaded voltage: AC 18 V ± 5% Loaded Voltage : AC 16 V ± 5% AT 1500 mA	
3. Ripple voltage	*** mV (RMS) MAX. AT Rated Loading	
4. Insulation resistance	Primary - secondary: DC 500 V 100 MΩ Min	
5. Dielectric withstand test	Primary - secondary: AC 3.64 KV 1 seconds	
6. Temperature rise	At rated loading 90°C max. For input coil (By resistance method) and 55°C max. on case surface (By use of thermometer)	
7. EFFICIENCY	≥ 79%	
8. Leadout	Primary	SAA PLUG IN TYPE
	Secondary	PVC cable length: 1.8 Meter Colour : GREY (RAL7035) Wire size: AWG#20/3C Plug : STRIPPED AND TINNED
9. Test circuit	<p>The diagram shows a transformer with a thermal fuse on the primary side. The secondary side is connected to a load circuit containing an ammeter (A), a voltmeter (V), and a variable load resistor.</p>	
10. Case	SAA48 colour = GREY (RAL7035)	

	REVISED	DRAWN	APPROVED
①	AMENDED PACKING QTY AND CARTON SIZE	JACKY 10/08/09	GARY 10/08/09
②	ADDED DATE CODE ON CASE AND DIMENSIONS	JACKY 07/12/09	GARY 07/12/09
③	ADDED PASSED LABEL ON CARTON	TODD 22/12/10	JACKY 22/12/10
④	AMENDED AC PINS DIMENSION & ADDED WIRES COLORS	ANLEI 01/11/12	ANLEI 01/11/12
⑤	CHANGED CROSS-SHAPED SCREW TO SHAPE SCREW ON CASE	MARK 31/08/15	FREDERICK 31/08/15

TE DRAWING NO: TE40-0001 R5

PART NO: 16VAC1500MPS/6

DESCRIPTION: AC ADAPTOR EI-48Q,16VAC1500mA, 3 WIRE - MEPS



THIS DRAWING AND SPECIFICATIONS ARE THE PROPERTY OF TELEPHONE EQUIPMENT (NSW) Pty Ltd AND SHALL NOT BE REPRODUCED OR USED IN ANY MANNER WITHOUT THE PRIOR WRITTEN CONSENT OF TELEPHONE EQUIPMENT (NSW) Pty Ltd

SIZE	A4	DATE	30/04/09	CHECKED	KEVIN 30/04/09		ORDER REF:	0420	SHEET 2 OF 3	TOLERANCES UNLESS OTHERWISE STATED X.= +/- .X= +/-0.5 .XX= +/-0.2
UNIT	MM	DRAWN	KEVIN	APPROVED	FRANK 30/04/09		CUSTOMER:	TE		
SCALE	NTS	MANU:				DATE:				

	REVISED	DRAWN	APPROVED
①	AMENDED PACKING QTY AND CARTON SIZE	JACKY 10/08/09	GARY 10/08/09
②	ADDED DATE CODE ON CASE AND DIMENSIONS	JACKY 07/12/09	GARY 07/12/09
③	ADDED PASSED LABEL ON CARTON	TODD 22/12/10	JACKY 22/12/10
④	AMENDED AC PINS DIMENSION & ADDED WIRES COLORS	ANLEI 01/11/12	ANLEI 01/11/12
⑤	CHANGED CROSS-SHAPPED SCREW TO SHAPE \perp . SCREW ON CASE	MARK 31/08/15	FREDERICK 31/08/15

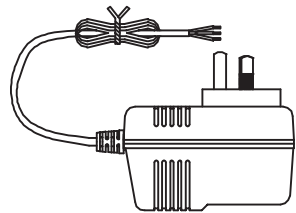

1 PC/WHITE BOX

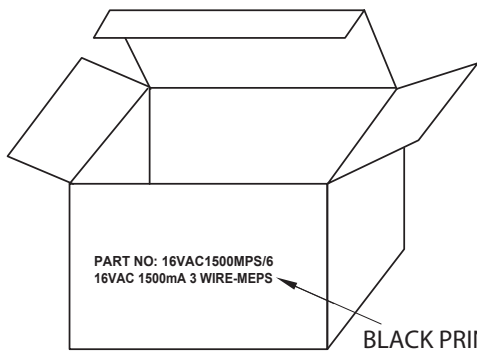

BLACK PRINTING

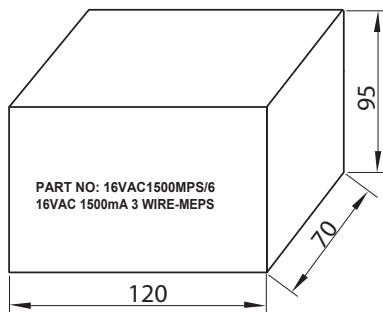

20 BOXES/CARTON ①

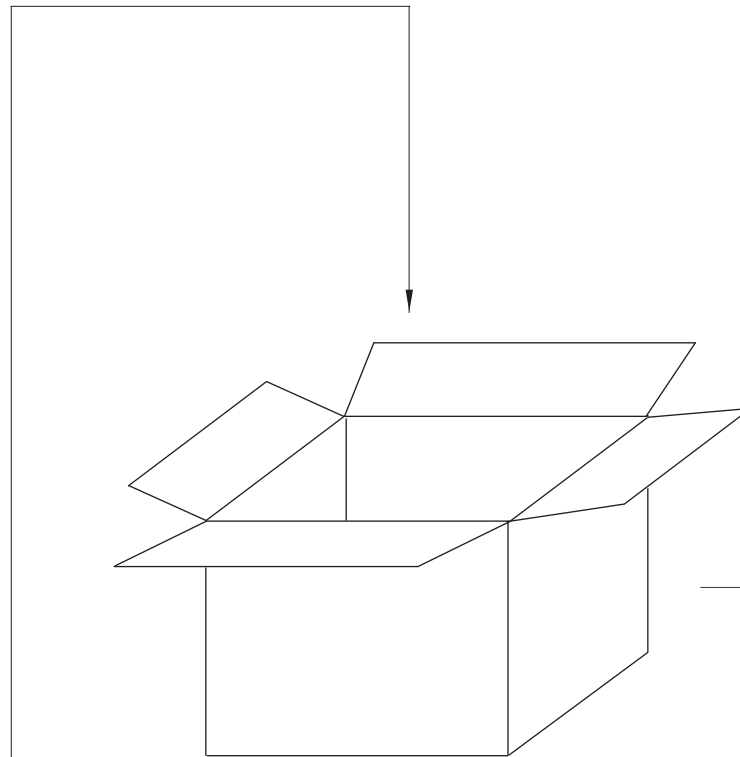

SHIPPING CARTON
PLEASE FOLLOW ORDER TO PRINT SHIPPING MARKS.

ADHESIVE TAPE

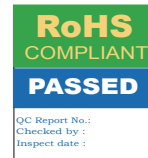
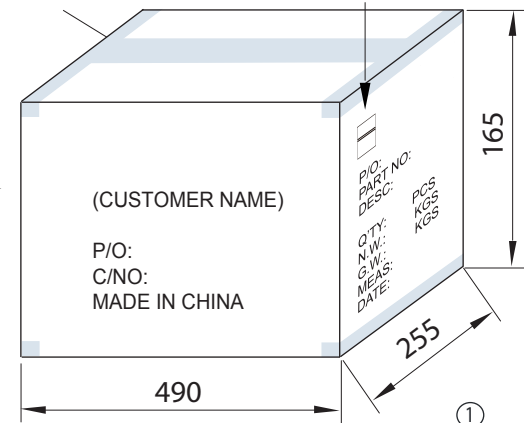

③

ONLY ONE RoHS+PASSED LABEL ON CARTON
RoHS LABEL(5X25MM)
GREEN GROUNDING YELLOW TEXT
PASSED LABEL(5X36MM)
BLUE GROUNDING WHITE TEXT
WHITE GROUNDING BLUE TEXT

①

TE DRAWING NO: TE40-0001 R5

PART NO: 16VAC1500MPS/6

DESCRIPTION: AC ADAPTOR EI-48Q,16VAC1500mA, 3 WIRE - MEPS



THIS DRAWING AND SPECIFICATIONS ARE THE PROPERTY OF TELEPHONE EQUIPMENT (NSW) Pty Ltd AND SHALL NOT BE REPRODUCED OR USED IN ANY MANNER WITHOUT THE PRIOR WRITTEN CONSENT OF TELEPHONE EQUIPMENT (NSW) Pty Ltd

SIZE	A4	DATE	30/04/09	CHECKED	KEVIN 30/04/09		ORDER REF:	0420	SHEET 3 OF 3	TOLERANCES UNLESS OTHERWISE STATED X.= +/-1 .X.= +/-0.5 .XX.= +/-0.2
UNIT	MM	DRAWN	KEVIN	APPROVED	FRANK 30/04/09		CUSTOMER:	TE		
SCALE	NTS	MANU:					DATE:			



Specifications TELLC0280

The TELLC0280 is the telephone lead with 606 Socket and 2 Meter length of Telephone Cord.

Colour: Ivory.

