



Specifications PRXMG5050+-V74

The PRXMG5050+-V74 is a Magellan 32-Zone Wireless Transceiver Control Panel.

Features:

- 2 serial outputs master/slave
- M2 two-way FSK hardware ready
- 8 on-board zones (16 with ATZ)
- Built-in transceiver (433 MHz)
- Expandable to 32 zones, 2 partitions, 32 users and 32 remotes
- 4-wire communication bus (connect up to 15 modules)
- Supports IP and cellular IP reporting
- Supports 16 PGMs (any of which can be wireless)
- App-based system control via BlueEye
- In-field firmware upgrade via 307USB And BabyWare remote or local
- Menu-driven programming for the Installer, Master and Maintenance codes
- Multiple telephone numbers for event reporting: 3 monitoring and 5 for Personal Dialing
- Calendar with Daylight savings Time
- StayD Mode
- Sleep arming method
- RF Jamming Supervision
- 512 events buffered.

P ▲ R ▲ D O X™



Specifications PRX278000033-P2C

The PRX278000033-P2C is a metal box enclosure for provision multiple module and panel mounting.

Features:

- Many punch-out holes for simple wiring
- Easy door removal
- Sizes: 28cm X 28cm X 7.6cm (11" x11" x 3")

P ▲ R ▲ D O X™



Specifications PRXK-TK278

The PRXK-TK278 is a BOM Kit for 1x tamper switch PRX2502302000-P2C and 1x tamper bracket PRX2781030000-P2C to suit with Paradox Metal Box Enclosure PRX2780000033-P2C; to protect against tampering (opening door or removal from wall).

P ▲ R ▲ D O X™

SP5500+ / SP6000+ / SP7000+ User Guide

4 to 32-Zone Expandable Security Systems



P ▲ R ▲ D O X™



English

Description

The Digigard DG75+ is an indoor digital dual-optic high-performance PIR motion detector. Featuring True Pet Immunity, the DG75+ allows one pet (up to 40kg/90lb) to move freely through the protected area without generating an alarm.

Installation

The DG75+ can be installed as either a flat-mount or corner-mount detector. At the recommended installation height of 2.1m (7ft) to 2.7m (9ft) ±10%, the DG75+ provides full coverage for distances of 1.5m (5ft) to 11m (35ft) (see Figure 2 on reverse). Ensure that the PCB height setting matches the actual installation height (see Figure 4 and Figure 5 on reverse).

WARNING:

- Install the unit according to the following instructions. Failure to do so may result in compromised detector performance.
- Do not install the detector near the following sources of interference: reflective surfaces, direct sunlight, moving cars, direct air flow from vents/fans/windows, sources of steam, oil vapor, infrared light and objects causing temperature changes such as heaters, refrigerators and ovens.
- Ensure that the installation site is free of any obstacles that may partially or completely obscure the detector’s field of view.
- False alarms can be caused by a pet climbing onto furniture. To prevent false alarms, ensure that furniture (0.9m (3ft) or higher) is not placed within 2.1m (7ft) of the detector. In addition, do not aim the detector at a stairway to which a pet may have access.
- Do not touch the sensor surface as this could result in a detector malfunction. If necessary, clean the sensor surface using a soft cloth with pure alcohol.

For CUL Listed applications, the unit shall be installed in accordance with Part 1 of the Canadian Electrical Code.

The DG75+’s Pet Immunity feature has not yet been investigated by UL.

Installing the DG75+

- Select the detector’s location.
- To remove the cover, remove the cover screw and use a screwdriver to release the cover release pin (see Figure 1 on reverse).
- Loosen the PCB screw and gently remove the PCB.
- Drill or punch out the selected knockout holes from the DG75+ back cover (see Figure 1 on reverse) and secure to surface using appropriate mounting screws.
- Ensure that the PCB height setting matches the actual installation height (see Figure 4 and Figure 5 on reverse). Failure to do so will compromise detector effectiveness. A walk-test should be performed following installation and any PCB adjustment to verify detector coverage (see “Walk-testing”).

Detector Settings

Detector settings can be modified using the three jumpers located on the DG75+ PCB (see Figure 4 on reverse).

Single or Dual Edge Processing (DUAL)

This setting determines the DSP (Digital Signal Processing) operational mode of the detector. Single Edge Processing mode should be used in normal

environments with minimal sources of interference. Dual Edge Processing Mode provides better false alarm rejection in the case where the detector is placed near sources of interference that can adversely affect the motion detector.

Digital Shield™ Setting (SHLD)

In Normal Shield mode, the detector is set for normal environments. In High Shield mode, the detector is set for high-risk environments (potential interferences) and therefore provides greatly increased false alarm immunity.

NOTE: In high shield mode, detection time for large movements will not be affected, however detection time for small movements or movements that occur far from the detector will be doubled.

LED Settings (LED)

Use this setting to enable or disable the green and red LEDs. Refer to “LED Feedback” on reverse.

Powering the Detector

Apply power by connecting the terminals “**AUX+**” and “**AUX-**” of the control panel to the “+” and “-” terminals of the detector (see Figure 3 on reverse). Powering the detector initiates a self-test and the red LED flashes for 5 seconds. When the red LED is no longer flashing, the detector is ready.

Adjusting the PCB Height

To ensure correct detector coverage and reduce false alarms, it is necessary to properly adjust the PCB height. To adjust the PCB height, loosen the PCB screw (see Figure 4 on reverse), slide the PCB up or down and align with the PCB height tab (see Figure 5 on reverse). When you reach the desired position, gently tighten the PCB screw. The optimum height for DG75+ installation is 2.1m, however the PCB can be adjusted to accommodate installations between 1.1m and 3.1m.

WARNING: Improper height adjustment will compromise detector effectiveness.

Walk-testing

At 20°C (68°F), in Normal Shield mode and Single Edge Processing mode, you should not be able to cross more than one complete zone (consisting of 2 beams, left and right sensor detecting elements) in the coverage area with any kind of movement; slow, fast walking or running. In High Shield mode, the amount of movement required to generate an alarm is doubled. The approximate width of a full beam at 11m (35ft) from the detector is 1.8m (6ft). To walk-test, always move across the detection path, not toward the detector.

Beam Pattern

The DG75+ features a detection range of 11m x 11m (35ft x 35ft) with a 90° viewing angle. To aid in selecting an installation site and performing walk-tests, refer to Figure 2 on reverse.

Español

Descripción

El Digigard DG75+ es un detector de movimiento infrarrojo digital para exteriores de funcionamiento superior con optica doble Con Inmunidad Real Contra Mascotas, el DG75+ permite a un animal de compañía (de hasta 40kg/ 90lb) pasear libremente por el área protegida sin que por ello genere una alarma.

Instalación

El detector DG75+ puede ser instalado en un montaje en superficie plana o en esquina. Instalado a la altura recomendada de 2.1m (7ft) a 2.7m (9ft) ±10%, el DG75+ ofrece una cobertura total a una distancia de 1.5m (5ft) hasta 11m (35ft) (ver la Figura 2 al verso). Verificar que la altura de la placa de circuito impreso coincide con la altura de la instalación (ver la Figura 4 y la Figura 5 al verso).

ADVERTENCIA:

- Instalar la unidad siguiendo las siguientes instrucciones. De lo contrario el rendimiento de los detectores podría verse afectado.
- No instalar el detector cerca de las siguientes fuentes de interferencia: superficies reflectantes, luz solar directa, automóviles en movimiento, corrientes de aire directas de sistemas de ventilación, ventiladores y ventanas, fuentes de vapor / humo de aceite, fuentes de luces infrarrojas y objetos que provoquen cambios de temperatura como aparatos de calefacción, refrigeradores y hornos.
- Comprobar que el lugar de la instalación está libre de obstáculos que podrían oscurecer el campo de visión del detector.
- Un animal de compañía que trepa sobre los muebles podría causar falsas alarmas. Para evitar falsas alarmas, no poner muebles (de 0.9m (3ft) o más de altura) a una distancia de 2.1m (7ft) o menos del detector. Además, evitar orientar el detector hacia una escalera por donde tenga acceso la mascota.
- No toque la superficie del sensor pues puede provocar un mal funcionamiento del detector. De ser necesario, limpiar la superficie del sensor con un paño delicado y alcohol puro.

Para aplicaciones homologadas por CUL, la unidad debe ser instalada en concordancia con la Parte 1 del Código Eléctrico Canadiense.

La característica de Inmunidad Contra Mascotas del DG75+ aún no ha sido evaluada por UL.

Instalación del DG75+

- Seleccionar la ubicación del detector.
- Para quitar la cubierta, retirar el tornillo de la cubierta y, liberar la lengüeta de sujeción de la cubierta (ver Figure 1 al verso) mediante un destornillador.
- Aflojar el tornillo de la placa de circuito impreso (PCI) y retirar delicadamente la PCI.
- Perforar los agujeros de la cubierta trasera del DG75+ (ver la Figura 1 al verso) y fijarla a la superficie usando los tornillos de montaje adecuados.
- Verificar que la altura de la placa de circuito impreso coincide con la altura de la instalación (ver la Figura 4 y la Figura 5 al verso). De lo contrario, la eficacia del detector se vería comprometida. Para verificar la cobertura del detector, se debe efectuar una prueba caminando después de la instalación y tras todo ajuste efectuado a la PCI (ver “Walk-testing”).

Configuración del Detector

Se puede modificar la configuración del detector mediante los tres puentes ubicados en la PCI del DG75+ (ver la Figura 4 al verso).

Procesamiento de Polaridad Simple o Doble (DUAL)

Esta configuración determina el modo de funcionamiento de Procesamiento Digital de Señales del detector. El Procesamiento de Polaridad Simple debe ser usado en ambientes normales con mínimas fuentes de interferencia. El Procesamiento de Polaridad Doble ofrece un mayor rechazo a las falsas alarmas si el detector está ubicado cerca de fuentes de interferencia que pueden afectarlo negativamente.

Configuración del Blindaje Digital Shield™ (SHLD)

En el modo Blindaje Normal, el detector está configurado para ambientes normales. En el modo de Blindaje Superior, el detector está configurado para ambientes de alto riesgo (interferencias potenciales) y por consiguiente brinda una inmunidad acrecentada contra las falsas alarmas.

NOTA: En el modo de blindaje superior el tiempo de detección de grandes movimientos no será afectado. Sin embargo, el tiempo de detección de pequeños movimientos o de movimientos que ocurran lejos del detector será doblado.

Configuración de LED (LED)

Usar esta configuración para habilitar o deshabilitar las luces LED verde y roja. Ver “Luces LED de Confirmación” al verso.

Encendido del Detector

Suministrar alimentación conectando los terminales “**AUX+**” y “**AUX-**” de la central a los terminales “+” y “-” del detector (ver la Figura 3 al verso). Encender el detector inicia una auto-prueba y la luz LED roja parpadea por 5 segundos. Cuando la luz LED roja deja de parpadear, el detector está listo.

Ajuste de la Altura de la PCI

Para asegurar la cobertura correcta del detector y disminuir las falsas alarmas, debe ajustarse correctamente la altura de la PCI. Para hacerlo, aflojar el tornillo de la PCI (ver la Figura 4), deslizar la PCI hacia arriba o abajo y alinearla con la lengüeta de altura de la PCI (ver la Figura 5) Cuando se alcance la posición deseada, ajustar delicadamente el tornillo de la PCI. La altura óptima de instalación del DG75+ es de 2.1m, sin embargo la PCI puede ser ajustada para permitir instalaciones entre 1.1m y 3.1m.

ADEVERTENCIA: El ajuste incorrecto de la altura afecta la eficacia del detector.

Prueba Caminando

A 20°C (68°F), en los modos de Blindaje Normal y de Procesamiento de Polaridad Simple, no se debería poder atravesar más de una zona completa (que consiste de 2 haces, elementos de detección izquierdo y derecho del sensor) en el área de cobertura con cualquier tipo de movimiento; caminando despacio,rápido o corriendo. En el modo de Blindaje Superior se requiere el doble de la cantidad de movimiento para generar una alarma. El ancho aproximado de un haz completo a 11m (35ft) del detector es de 1,8m (6ft). Para efectuar la prueba-caminado, moverse siempre atravesando la trayectoria de detección, no hacia el detector

Estructura de Haces

El alcance de detección del DG75+ es de 11m x 11m (35ft x 35ft) con un ángulo de visión de 90°. Para ayuda sobre la selección de un lugar de instalación y la realización de pruebas caminando, ver la Figura 2.

Français

Description

Le Digigard DG75+ est un détecteur de mouvement numérique haute performance à optiques doubles pour l’intérieur. Doté d’une véritable insensibilité aux animaux, il permet à un animal (de moins de 40 kg/90 lb) de circuler librement dans un secteur protégé sans déclencher d’alarme.

Installation

Le DG75+ peut être installé comme détecteur de coin ou sur surface plane. À la hauteur d’installation recommandée, soit entre 2,1 m (7 pi) et 2,7 m (9 pi) ±10 %, le DG75+ offre une couverture entière pour des distances de 1,5 m (5

pi) à 11 m (35 pi) (voir Figure 2 au verso). S’assurer que le réglage de la hauteur de la carte de circuits imprimés corresponde à la hauteur réelle de l’installation (voir Figure 4 et Figure 5 au verso).

AVERTISSEMENT :

- Installer l’unité en suivant les instructions suivantes, sans quoi la performance du détecteur pourrait être compromise.
- Éviter d’installer le détecteur à proximité des sources d’interférence suivantes : surfaces réfléchissantes, circulation d’air provenant de dispositifs de ventilation, ventilateurs, fenêtres, sources de vapeur d’eau ou de vapeur d’huile, sources de lumière à infrarouge et articles entraînant des variations de température, tels que les appareils de chauffage, les réfrigérateurs et les fours.
- S’assurer que le lieu d’installation ne présente pas d’obstacles qui pourraient nuire au champ de vision du détecteur.
- Des fausses alarmes peuvent être causées par des animaux domestiques grimpant sur des meubles. Pour prévenir les fausses alarmes, s’assurer que les meubles (0,9 m (3 pi) ou plus) soient placés à plus de 2,1 m (7 pi) du détecteur. Éviter aussi d’orienter le détecteur vers un escalier accessible à un animal domestique.
- Ne pas toucher à la surface du capteur, car cela pourrait entraîner un mauvais fonctionnement du détecteur. Au besoin, nettoyer la surface du capteur à l’aide d’un chiffon doux et d’alcool pur.

Pour les applications listées CUL, l’unité doit être installée conformément à la Partie 1 du Code canadien de l’électricité.

La caractéristique d’insensibilité aux animaux du DG75+ n’a pas encore été examinée par l’UL.

Installation du DG75+

- Choisir l’emplacement du détecteur.
- Utiliser un tournevis pour desserrer la languette de dégagement et retirer le couvercle (voir Figure 1 au verso).
- Desserrer la vis de la carte de circuits imprimés et retirer cette dernière avec soin.
- Perçer les trous sur le couvercle arrière du DG75+ (voir Figure 1 au verso) et le fixer à la surface à l’aide des vis appropriées.
- S’assurer que le réglage de la hauteur de la carte de circuits imprimés corresponde à la hauteur réelle de l’installation (voir Figure 4 et Figure 5 au verso), sans quoi l’efficacité du détecteur pourrait être compromise. Un essai de marche devrait être effectué à la suite de toute installation et d’ajustement de carte de circuits imprimés afin de vérifier la couverture du détecteur (voir « Essai de marche »).

Réglages du détecteur

Les réglages du détecteur peuvent être modifiés à l’aide des trois cavaliers situés sur la carte de circuits imprimés du DG75+ (voir Figure 4 au verso).

Traitement simple ou divisé (DUAL)

Ce paramètre détermine le mode opérationnel de traitement numérique du signal du détecteur. Le mode de traitement simple devrait être utilisé dans des conditions d’environnement normal avec peu de sources d’interférence. Le mode de traitement divisé offre un meilleur rejet des fausses alarmes dans le cas où le détecteur est placé près de sources d’interférence pouvant nuire au détecteur de mouvement.

Réglage de l’algorithme numérique Shield™ (SHLD)

En mode de protection normale, le détecteur est réglé pour des conditions d’environnement normal. En mode de protection élevée, le détecteur est réglé pour des conditions d’environnement à haut risque (possibilité d’interférences) et est donc pourvu d’une immunité inégalee contre les fausses alarmes.

NOTE : En mode blindage élevé, le temps de détection pour les mouvements importants ne sera pas affecté. Cependant, le temps de détection pour les petits mouvements ou les mouvements se produisant loin du détecteur sera doublé.

Réglages des DEL (DEL)

Utiliser ce réglage pour activer ou désactiver la DEL rouge et la DEL verte (DG65 seulement). Voir « Rétroaction de la DEL » au verso.

Mise sous tension du détecteur

Alimenter le détecteur en branchant les bornes “**AUX+**” et “**AUX-**” du panneau de contrôle aux bornes “+” et “-” du détecteur (voir Figure 3 au verso). La mise sous tension du détecteur lance un autotest et le voyant rouge clignote pendant 5 secondes. Lorsque le voyant rouge cesse de clignoter, le détecteur est prêt.

Ajustement de la hauteur de la carte de circuits imprimés

Afin d’assurer la couverture adéquate du détecteur et de réduire les fausses alarmes, il est nécessaire d’ajuster correctement la hauteur de la carte de circuits imprimés. Pour ajuster la hauteur, desserrer la vis retenant la carte de circuits imprimés (voir Figure 4 au verso), faire glisser cette dernière vers le haut ou vers le bas et l’aligner avec l’onglet de hauteur (voir Figure 5 au verso). Une fois la position désirée obtenue, resserrer la vis de la carte de circuits imprimés avec soin. La hauteur optimale pour une installation de DG55/DG65 est de 2,1 m. Cependant, la carte de circuits imprimés peut être ajustée de façon à accommoder des installations entre 1,1 m et 3,1 m.

AVERTISSEMENT : Un mauvais ajustement de la hauteur pourrait compromettre l'efficacité du détecteur.

Essai de marche

À 20 °C (68 °F), en mode de protection normale et en mode de traitement simple, un humain ne devrait pas pouvoir traverser plus d'une zone complète (composé de 2 faisceaux, détecteurs gauche et droit du capteur) dans la zone de couverture, et ce peu importe le mouvement effectué : marche lente, rapide ou course. En mode de protection élevée, la quantité de mouvement nécessaire à la génération d'une alarme est doublée. La largeur approximative d'un faisceau maximal à 11 m (35 pi) du détecteur est de 1,8 m (6 pi). Lors de l'essai de marche, s'assurer de toujours marcher d'un côté à l'autre de la trajectoire de détection, et non en direction du détecteur.

Diagramme de faisceau

Le DG75+ offre une portée de détection de 11 m x 11 m (35 pi x 35 pi) avec angle de prise de vue de 90°. Pour aider à la sélection du lieu d'installation et à l'exécution des essais de marche, voir la Figure 2 au verso.

Figure/Figura 1 Overview / Vista General / Vue d'ensemble

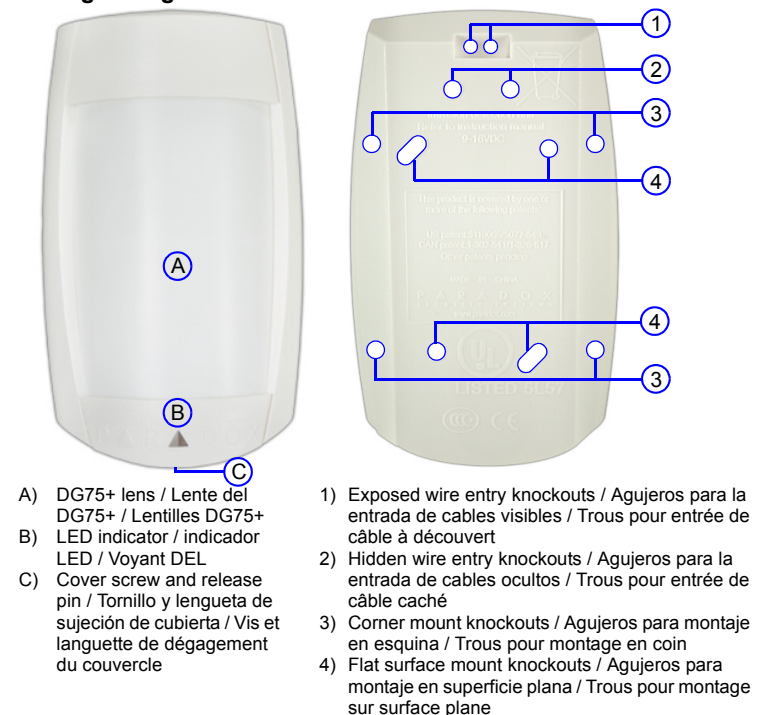

Figure/Figura 2 DG75+ Pet Array Beam Pattern / Estructura de Haces / Diagramme de faisceau

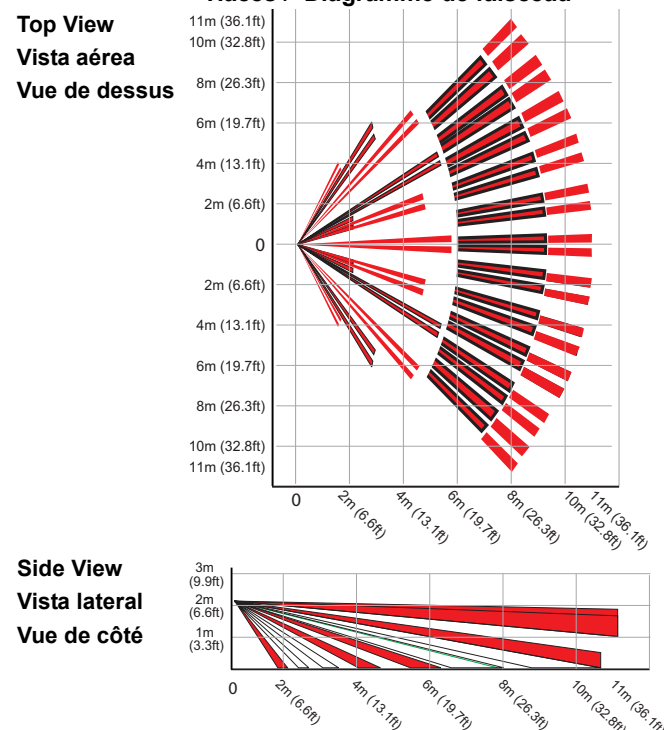

Figure/Figura 3 Wiring / Cableado / Câblage

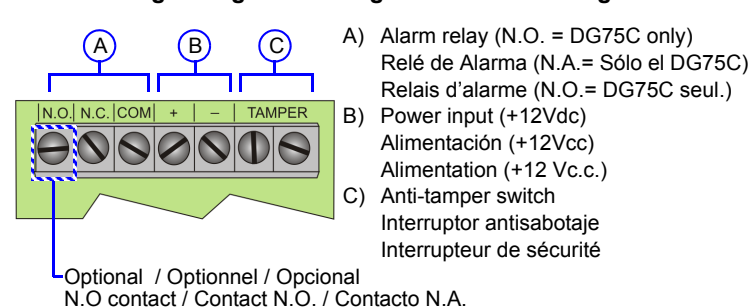

Figure/Figura 4 PCB Overview / Vista General / Vue d'ensemble

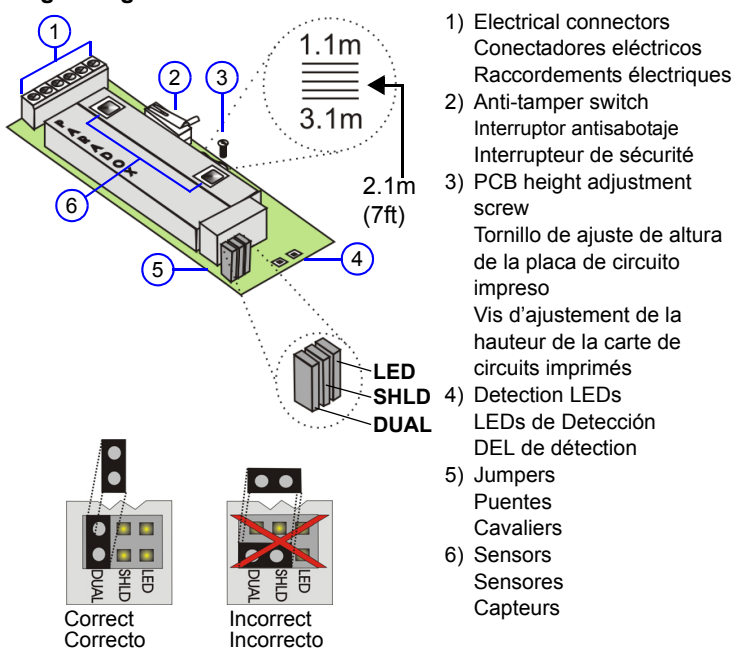

Table/Tableau/Tabla 1

Jumper Settings / Ajuste de los Puentes / Réglages des cavaliers

LED	LED Indicator(s) Indicadores LED Voyant(s) DEL(s)
	OFF = Disabled / Deshabilitado / Désactivé ON = Enabled / Habilitado / Activé Δ
SHLD	Digital Shield (Sensitivity) Blindaje Shield Digital (Sensibilidad) Algorithme numérique Shield (Sensibilité)
	OFF = High Shield / Blindaje Superior / Protection élevée ON = Normal Shield / Blindaje Normal / Protection normale Δ
DUAL	Processing Type Tipo de Procesamiento Type de traitement
	OFF = Dual Edge / Polaridad Doble / Divisé ON = Single Edge / Polaridad Simple / Simple Δ

Δ=default, de fábrica, par défaut

Figure/Figura 5 PCB Height / Altura de la PCI / Hauteur du PCB

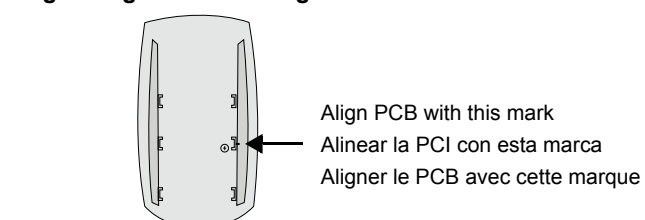

LED Feedback / LED de Confirmación / Rétroaction DEL

Legend / Legend / Légende	
R = Red / Rojo / Rouge G = Green / Verde / Verte	
△ = Off / Désact. ▲ = On / Act. ⚡ = Flashing / Parpadeo / Clignote	
LED State	Condition
▲ R	On 3 seconds = Alarm signal generated Encendido 3 segundos = Se generó señal de alarma Allumée 3 secondes = Signal d'alarme généré
⚡ R	Flash = Movement signal does not reach required energy for an alarm Parpadeo = Señal de movimiento no alcanza la energía necesaria para generar una alarma Clignote = Signal de mouvement n'atteint pas l'énergie requise pour une alarme
▲ R	Flash 5 seconds = Power-up self-test Parpadeo 5 segundos = Prueba automática en encendido Clignote 5 secondes = Test automatique de mise sous tension
⚡ R	Flash = Signal does not match the characteristics of an alarm (non-movement signal) Parpadeo = La señal no reúne las características de una alarma (señal de sin movimiento) Clignote = Signal ne correspond pas aux caractéristiques d'une alarme (signal de non-mouvement)
▲ G	

Specifications

Pet immunity	Up to 40kg (90lbs)
Sensor type	Dual Element Infrared x 2
Coverage -90° (standard)	11m (35ft) X 11m (35ft)
Installation Height	2.1m to 2.7m (7ft to 9ft)
RFI / EMI rejection	10V/m rejection from 10MHz to 1GHz
Sensor geometry	Rectangular
Voltage input	Typically 11 to 16Vdc
Current consumption	15mA max. / 6mA min. (LED disabled)
Anti-tamper switch	150mA / 28Vdc, N.C.
Lens	2nd generation Fresnel lens, LODIFF®, segments
Alarm output*	DG75+ = Form A relay 100mA/28Vdc, N.C. DG75C = Form C relay 200mA/ 28Vdc, N.C./N.O.
Detection speed	0.2m/s to 3.5m/s (0.6ft/s to 11.5ft/s) Ingress
Operating temperature	-10°C to +50°C (14°F to +122°F)
Environmental Standards	Complies with EN 50131 Security Grade 2 / Environmental Class I

* Form C relay has not been investigated for compliance to EN 50131.
Patents: One or more of the following US patents may apply: 7046142, 6215399, 6111256, 6104319, 5920259, 5886632, 5721542, 5287111, and RE39406 and other pending patents may apply. Canadian and international patents may also apply. LODIFF® lens: patent #4,787,722 (U.S.). Canadian and international patents may also apply. LODIFF® a registered trademark of Fresnel Technologies Inc.
Trademarks: Digigard and Shield are trademarks or registered trademarks of Paradox Ltd. or its affiliates in Canada, the United States and/or other countries.
Certification: For the latest information on products approvals, such as UL and CE, please visit www.paradox.com.
Warranty: For complete warranty information on this product please refer to the Limited Warranty Statement found on the website www.paradox.com/terms. Your use of the Paradox product signifies your acceptance of all warranty terms and conditions.
 © 2015 Paradox Ltd. All rights reserved. Specifications may change without prior notice.

Especificaciones

Inmune a mascotas	De hasta 40kg (90lbs)
Tipo de Sensor	Infrarrojo de Dos Elemento (x 2)
Cobertura -90° (estándar)	11m (35ft) X 11m (35ft)
Altura de Instalación	2.1m a 2.7m (7ft a 9ft)
Rechazo a interferencias electromagnéticas y de radiofrecuencia	10V/m de rechazo entre 10MHz a 1GHz
Geometría del Sensor	Rectangular
Tensión de entrada	Típico de 11 a 16Vcc
Consumo de corriente	15mA máx. / 6mA mín. (LED deshabilitado)
Interruptor antisabotaje	150mA/28Vcc, N.C.

Lente	Lente Fresnel de 2da generación, LODIFF®, segmentos
Salida de alarma*	DG75+ = Relé de Forma A de 100mA/28Vcc, N.C. DG75C = Relé de Forma C de 200mA/28Vcc, N.C./N.A.
Velocidad de detección	Ingreso 0.2m/s a 3.5m/s (0.6ft/s a 11.5ft/s)
Temperatura de funcionamiento	-10°C a +50°C (14°F a +122°F)
Estándares Ambientales	Cumple con EN 50131 Security Grade 2 / Environmental Class I

* El relé de Forma C no ha sido examinado respecto a su conformidad con EN 50131.

Patentes: Una o más de las siguientes patentes EE.UU. podría aplicarse: 7046142, 6215399, 6111256, 6104319, 5920259, 5886632, 5721542, 5287111, y RE39406 y otras patentes pendientes podrían aplicarse. Patentes canadienses e internacionales también podrían aplicarse. Lente LODIFF®: patente #4,787,722 (EE.UU.). Patentes canadienses e internacionales también podrían aplicarse. LODIFF® es una marca registrada de Fresnel Technologies Inc.

Marcas de comercio: Digigard y Shield son marcas de comercio o marcas registradas de Paradox Ltd. o de sus afiliados en Canadá, Estados Unidos y/o otros países.

Certificación: Para información actualizada respecto a la homologación de productos, como UL y CE, sírvase visitar nuestro sitio Web en www.paradox.com.

Garantía: Para una información detallada acerca de la garantía de este producto consultar la Declaración de Garantía Limitada (en inglés) que se encuentra en el sitio web de paradox: www.paradox.com/terms. El uso de este producto Paradox significa la aceptación de todos los términos y condiciones de la garantía.

© 2015 Paradox Ltd. Todos los derechos reservados. Las especificaciones pueden cambiar sin previo aviso.

Spécifications

Insensibilité aux animaux	Jusqu'à 40 kg (90 lb)
Type de capteur	Élément double infrarouge x 2
Couverture -90° (standard)	11 m (35 pi) X 11 m (35 pi)
Hauteur d'installation	2,1 m à 2,7 m (7 pi à 9 pi)
Protection contre les perturbations électromagnétiques et les interférences radiofréquences	Réjection de 10 V/m entre 10 MHz et 1GHz
Géométrie du capteur	Rectangulaire
Tension d'entrée	Généralement 11 à 16 Vc.c.
Consommation de courant	15 mA max. / 6 mA min. (DEL désact.)
Interrupteur de sécurité	150 mA / 28 Vc.c., N.F.
Lentilles	Lentilles Fresnel 2ème génération, segments LODIFF®
Sortie d'alarme*	DG75+ = Relais de forme A de 100 mA / 28 Vc.c., N.F. DG75C = Relais de forme C de 200 mA / 28 Vc.c., N.F./N.O.
Vitesse de détection	Ingress 0,2 m/s à 3,5 m/s (0,6 pi/s à 11,5 pi/s)
Température de fonctionnement	-10°C à +50°C (14°F à +122°F)
Standards environnementaux	Conforme EN 50131 Security Grade 2 / Environmental Class I

* Le relais de forme C n'a pas encore été examiné pour la conformité avec EN 50131.

Brevets: Un ou plusieurs des brevets suivants peuvent s'appliquer : 7046142, 6215399, 6111256, 6104319, 5920259, 5886632, 5721542, 5287111, et RE39406 et d'autres brevets en instance. Des brevets canadiens et internationaux peuvent aussi s'appliquer. Lentilles LODIFF® : brevet #4,787,722 (U.S.). LODIFF® est une marque déposée de Fresnel Technologies Inc.

Marques de commerce: Digigard et Shield sont des marques de commerce ou des marques de commerce déposées de Paradox Ltée ou de ses sociétés affiliées au Canada, aux États-Unis et/ou dans d'autres pays.

Certification: Pour les renseignements les plus récents concernant l'approbation UL et CE des produits, veuillez visiter le www.paradox.com.

Garantie: Pour tous les renseignements sur la garantie de ce produit, veuillez vous référer à la Déclaration de garantie limitée qui se trouve sur le site Web au www.paradox.com/terms. L'utilisation des produits Paradox signifie l'acceptation de toutes les modalités et conditions de la garantie.

© Paradox Ltée, 2015. Tous droits réservés. Spécifications sujettes à changement sans préavis.



Specifications PRXK10V-N3Q

The PRXK10V-N3Q is a 10-Zone Hardwired LED Keypad Module (Vertical).

Features:

- Supports StayD Mode
- 10-zone LED display
- Separate Arm, Sleep, Stay and Off LEDs per partition
- Patented Key Light display (button lights up to indicate an open zone)
- 1 keypad zone input
- Independently set chime zones
- 7 one-touch action buttons
- 3 keypad-activated panic alarms
- Adjustable backlight
- Connects to 4-wire communication bus
- Compatible with MG5000, MG5050, MG5075, and Spectra SP series

P ▲ R ▲ D O X™

MAGELLAN™

K10V/H - User's Quick Reference Guide

KEYPAD OVERVIEW

Partition 1 Status Partition 2 Status

Arm (red), Sleep (yel), Stay (grn):
On = Partition armed
Off = Partition disarmed
Flash = Exit Delay
Fast Flash* = Exit Delay (final 10 sec.)
Fast Flash* = Partition in alarm

* Audible Indicators:
Continuous beep = Alarm
Variable beep = Fire alarm
Intermittent beep = Beginning of exit delay
Fast beep = Final 10 sec. of exit delay

 = Press once + [MASTER CODE] for Quick Menu Programming

On = StayD Mode Enabled

Off Light (red):
On = Disarmed
Off = System armed

AC Light
On = Power on
Off = Power off

Zone Display:
Keys [1] to [0(10)] correspond to zones 1 to 10 respectively.
Key Lit: Open or entry delay
Key Flash: In alarm

[TBL] Trouble display
On = Trouble(s) occurring

[MEM] Alarm memory display
On = Alarm(s) occurred

[BYP] Bypass programming
On = Zone(s) bypassed

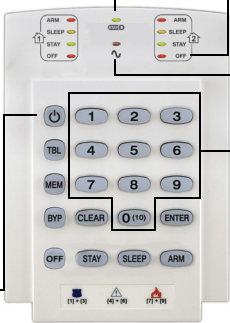

ARMING AND DISARMING

**TO ARM
WHEN LEAVING...**



**TO ARM
WHEN STAYING...**



To Regular Arm:

1. Close all zones in the desired partition.
2. Press [ARM].
3. Enter your [ACCESS CODE]*.

To Stay Arm:

1. Press the [STAY] key.
2. Enter your [ACCESS CODE]*.

To Sleep Arm:

1. Press the [SLEEP] key.
2. Enter your [ACCESS CODE]*.

To Disarm:
[OFF] + [ACCESS CODE]*

* If needed, press button(s) corresponding to desired partition(s). For two partitions, press the other key after the confirmation beep.



PANIC ALARMS

To send a silent or audible alarm to your Security Company, press and hold one of the button combinations listed for 3 seconds.

Panic Alarm Type	Button Combinations
Police	Press [1] & [3]
Medical	Press [4] & [6]
Fire	Press [7] & [9]

TROUBLE DISPLAY

When a trouble condition occurs, the [TBL] key will illuminate.

1. Press the [TBL] key. The key will flash and number(s) corresponding to the trouble(s) will illuminate.
2. Read the corresponding explanation from the trouble list in the MG5000 User Guide.
3. Press the [CLEAR] key to exit.

BYPASS PROGRAMMING

Bypassed zones remained unarmed when the partition is armed.

1. Press the [BYP] key.
2. Enter your [ACCESS CODE]*.
3. The corresponding key of all open zones will illuminate. Select the zone(s) you want to bypass by entering the one-digit zone number. The zone key will flash.
4. Press the [ENTER] key to save and exit.

ALARM MEMORY DISPLAY

To view the alarms that occurred during the last armed period:

1. Disarm the system.
2. Press the [MEM] key.
3. The corresponding zone numbers that were in alarm the last time the system was armed will illuminate.
4. Press the [CLEAR] key to exit.

KEYPAD SETTINGS

To mute the keypad:

Press and hold the [CLEAR] key for 6 seconds to enable or disable Keypad Muting.

To modify the backlight:

1. Press and hold the [MEM] key for 3 seconds.
2. The [MEM] key will illuminate.
3. Press the [MEM] key to set the desired backlight level.
4. Press [CLEAR] or [ENTER] to exit.

CHIME PROGRAMMING

A Chime Enabled zone will advise you every time it is opened by causing your keypad to beep.

1. Press & hold the corresponding zone key for 3 seconds (Accept beep = Chime enabled, Fail beep = Chime disabled).

© Paradox Security Systems Ltd., 2005-2015.
Magellan is a trademark or registered trademark of Paradox Security Systems (Bahamas) Ltd. and its affiliates in Canada, the United States and/or other countries. All rights reserved.

P ▲ R ▲ D O X™

PARADOX.COM

Printed in Canada 11/2015

K10VH-EQ04



Specifications DFMWP16

The DFMWP16 is combo siren and strobe (slim design).

- New design
- Siren tone selectable for different applications
- Sound volume adjustable: low dB for testing and high dB for normal operation
- Bright: new LED strobe design
- Independent siren and strobe operation
- High quality UV treated case
- Weatherproof
- Front and back tampers
- EOLRs built in, suitable for most major alarm panels

Operating voltage: 9-15VDC

SPL @ 1meter: 110dB

Siren current draw: 150mA

Strobe current draw: 50mA

Siren tone selectable: Tone 1: warble; Tone 2: Hi/Lo

Dimension: 200 x 110 x 40mm





WP16 Combo Siren/Strobe

Voltage: 9-15VDC

Current: Max 150mA @ 12VDC

High Volume: 110±3 dB @ 1meter

Low Volume: 95±3 dB @ 1meter

Tone 1: Warble

Tone 2: Hi/Lo

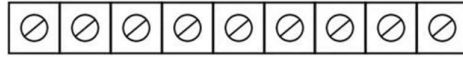
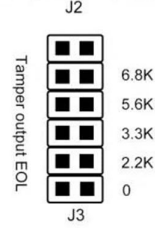
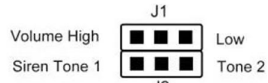

+ Siren - + Strobe - + LED - Tamper Spare
Input Input Night Comfort Output





Specifications DFMWP08

The DFMWP08 is indoor top hat piezo.

Input voltage: 12VDC

SPL @ 1meter: 105dB

Current draw: 90mA





VRLA 12V7AH

SA12V7

Specifications

Nominal Voltage	12 V	
Nominal Capacity 20HR	7.0 AH	
Dimensions	Length	151±1mm (5.94 inches)
	Width	65±1mm (2.56 inches)
	Container Height	95±1mm (3.74 inches)
	Total Height (with terminal)	100±1mm (3.94 inches)
Approx Weight	Approx 2.10 kg (4.63 lbs)	
Terminal	F1	
Container Material	ABS Plastic	
Lead Material	Purity Lead 99.995%	
Sulfuric Acid	Distilled Sulfuric Acid (Zero metal content)	
Separator	AGM	
Rated Capacity	7.00 AH/0.350A	(20hr, 1.80V/cell, 25°C/77°F)
	6.53 AH/0.653A	(10hr, 1.80V/cell, 25°C/77°F)
	6.00 AH/1.20A	(5hr, 1.75V/cell, 25°C/77°F)
	5.37 AH/1.79A	(3hr, 1.75V/cell, 25°C/77°F)
	4.55 AH/4.55A	(1hr, 1.60V/cell, 25°C/77°F)
Max. Discharge Current	105A (5s)	
Internal Resistance	Approx 23mΩ	
Operating Temp.Range	Discharge	: -15 - 50°C (5 - 122°F)
	Charge	: 0 - 40°C (32 - 104°F)
	Storage	: -15 - 40°C (5 - 104°F)
Nominal Operating Temp.Range	25±3°C (77±5°F)	
Cycle Use	Initial Charging Current less than 2.1A. Voltage 14.4V - 14.7V at 25°C (77°F) Temp.Coefficient -30mV/°C	
Standby Use	No limit on Initial Charging Current Voltage 13.5V - 13.8V at 25°C (77°F) Temp.Coefficient -20 mV/°C	
Capacity affected by Temperature	40°C (104°F) 103% 25°C (77°F) 100% 0°C (32°F) 86%	
Self Discharge	Sentry AGM series batteries may be stored for up to 6 months at 25°C (77°F) and then a freshening charge is required. For higher temperatures the time interval will be shorter.	



Applications

- All purpose
- Standby Applications
- Recreation Vehicles
- Uninterruptible Power Supply (UPS)
- Electric Power System (EPS)
- Fire & Security
- Generators
- Medical Equipment

Dimensions

F1 Terminal

Unit: mm (inches)

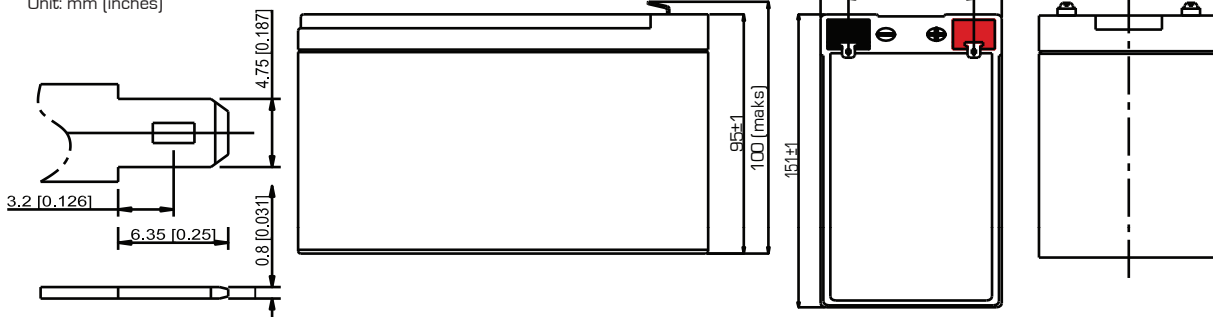

Constant Current Discharge (Amperes) at 25°C (77°F)

F.V./Time	5min	10min	15min	20min	30min	45min	1h	2h	3h	4h	5h	6h	8h	10h	20h
1.85V/cell	18.0	12.8	10.48	8.79	6.53	4.79	3.86	2.29	1.69	1.36	1.14	0.98	0.774	0.640	0.345
1.80V/cell	21.4	14.3	11.4	9.44	6.94	5.05	4.03	2.38	1.74	1.40	1.17	1.01	0.791	0.653	0.350
1.75V/cell	24.2	15.6	12.2	10.0	7.29	5.27	4.18	2.45	1.79	1.43	1.20	1.03	0.805	0.663	0.357
1.70V/cell	26.7	16.7	12.9	10.5	7.59	5.46	4.32	2.51	1.83	1.46	1.22	1.05	0.817	0.672	0.361
1.65V/cell	28.8	17.7	13.5	10.9	7.86	5.62	4.46	2.57	1.86	1.48	1.23	1.06	0.826	0.680	0.365
1.60V/cell	30.6	18.6	14.1	11.3	8.09	5.76	4.55	2.61	1.89	1.50	1.25	1.07	0.834	0.685	0.367

Constant Power Discharge (Watts/Cell) at 25°C (77°F)

F.V./Time	5min	10min	15min	20min	30min	45min	1h	2h	3h	4h	5h	6h	8h	10h	20h
1.85V/cell	34.2	24.5	20.2	17.1	12.8	9.44	7.64	4.56	3.37	2.72	2.29	1.99	1.565	1.296	0.701
1.80V/cell	40.2	27.2	21.9	18.3	13.5	9.91	7.96	4.72	3.47	2.79	2.34	2.03	1.593	1.318	0.708
1.75V/cell	45.1	29.5	23.3	19.3	14.2	10.3	8.23	4.85	3.55	2.85	2.39	2.06	1.616	1.344	0.719
1.70V/cell	49.2	31.3	24.5	20.1	14.7	10.6	8.48	4.96	3.62	2.89	2.42	2.09	1.633	1.347	0.725
1.65V/cell	52.6	32.9	25.5	20.8	15.2	10.9	8.73	5.05	3.68	2.93	2.45	2.11	1.649	1.359	0.731
1.60V/cell	55.5	34.3	26.3	21.5	15.5	11.2	8.88	5.12	3.72	2.96	2.47	2.13	1.660	1.367	0.734

Discharge Characteristics

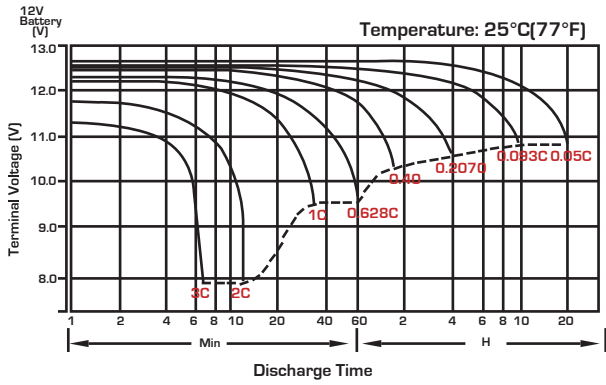

Float Charging Characteristics

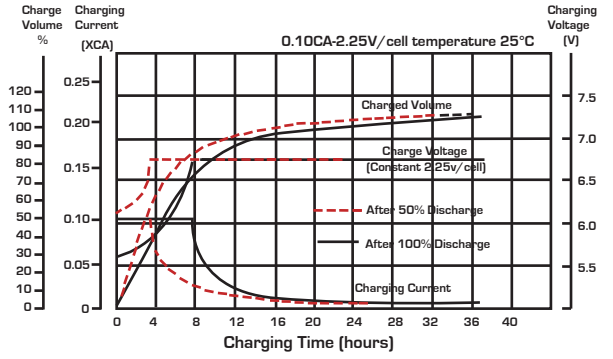

Temperature Effects in Relation to Battery Capacity

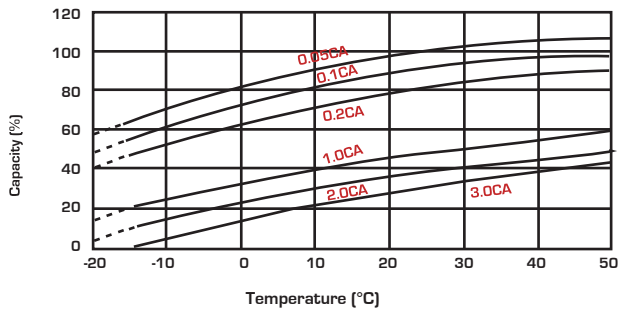

Effect of Temperature on Long Term Float Life

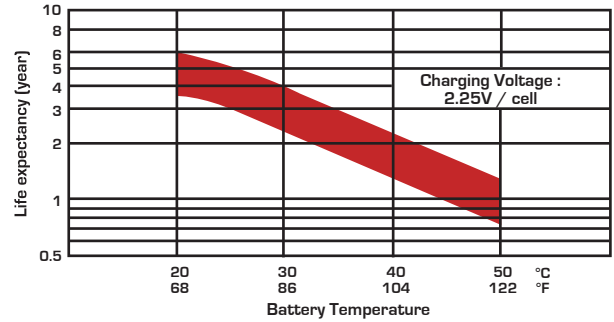

Cycle Life in Relation to Depth of Discharge

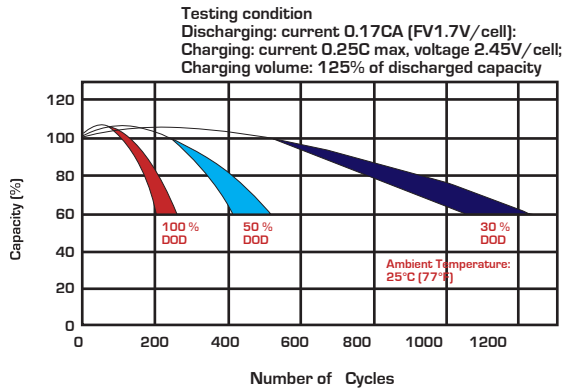

Self Discharge Characteristics

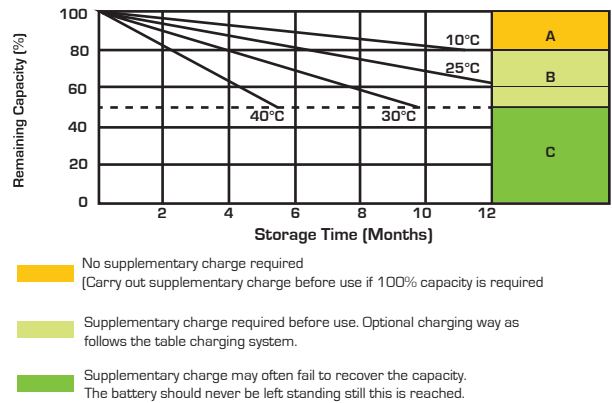

Charging System

DOD	Current Limit (A)	Constant Voltage (V)	Fully Charged Time (h)
20	0.15C ₁₀	13.5-13.8 vpc (12V)	10
	0.20C ₁₀	6.75-6.9 vpc (6V)	8
50	0.15C ₁₀	13.5-13.8 vpc (12V)	15
	0.20C ₁₀	6.75-6.9 vpc (6V)	12
80	0.15C ₁₀	13.5-13.8 vpc (12V)	16
	0.20C ₁₀	6.75-6.9 vpc (6V)	14
100	0.15C ₁₀	13.5-13.8 vpc (12V)	20
	0.20C ₁₀	6.75-6.9 vpc (6V)	18

State of Charge (SOC)

Open Circuit Voltage (V/cell)	Open Circuit Voltage (12V/cell)	Open Circuit Voltage (6V/cell)	State of Charge (% of full charge capacity)
2.14-2.15	12.84-12.90	6.42-6.46	100
2.12-2.13	12.72-12.78	6.36-6.39	90
2.11	12.66	6.33	80
2.09	12.54	6.27	70
2.07	12.42	6.21	60
2.05	12.30	6.15	50



Sealed Performance Batteries

Domestic Sales | Ph: +61 (0)7 3386 1102 | Fax: +61 (0)7 3102 9913

sales@spb.net.au | www.sealedperformance.com.au

National Warehouse | 1 Ant Road | Yatala, Brisbane QLD 4207

Melbourne Office | 2/9 Compark Circuit | Mulgrave, Melbourne VIC 3170

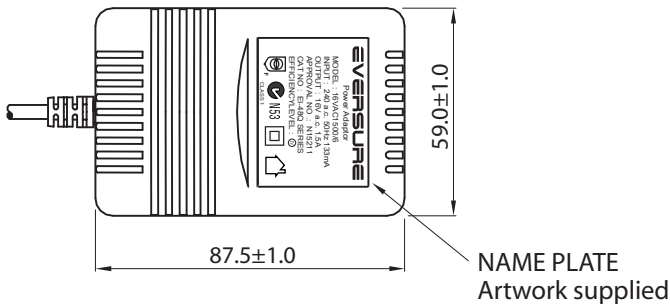
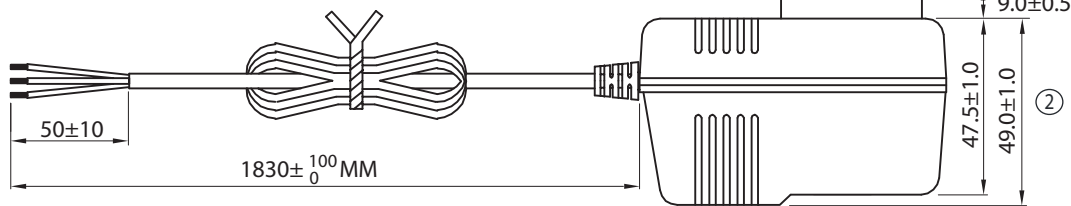
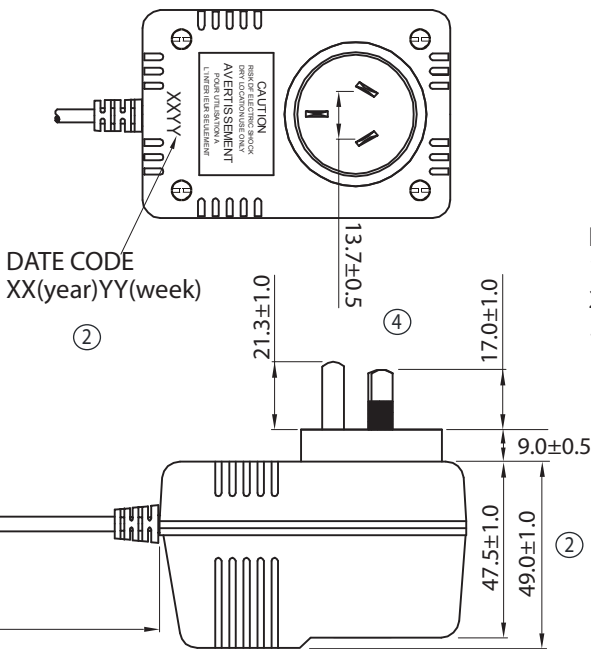
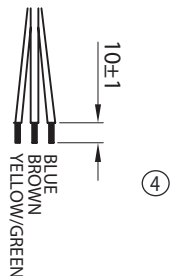

	REVISED	DRAWN	APPROVED
①	AMENDED PACKING QTY AND CARTON SIZE	JACKY 10/08/09	GARY 10/08/09
②	ADDED DATE CODE ON CASE AND DIMENSIONS	JACKY 07/12/09	GARY 07/12/09
③	ADDED PASSED LABEL ON CARTON	TODD 22/12/10	JACKY 22/12/10
④	AMENDED AC PINS DIMENSION & ADDED WIRES COLORS	ANLEI 01/11/12	ANLEI 01/11/12
⑤	CHANGED CROSS-SHAPED SCREW TO SHAPE SCREW ON CASE	MARK 31/08/15	FREDERICK 31/08/15

- NOTES:
1. OUTPUT CORD: 20AWGX3C 1.83M Lead Free GREY (RAL7035)
 2. CASE: GREY (RAL7035)
 3. SECURITY SCREW IS AN ESSENTIAL REQUIREMENT, BOTH "⊥" AND "△" SHAPE ARE ACCEPTABLE

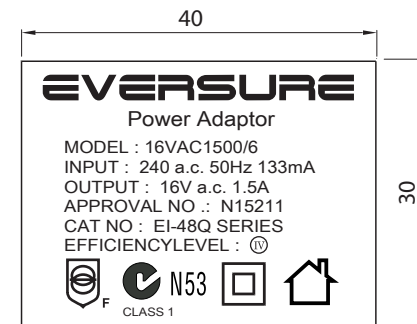

LABEL ARTWORK
Black word on Silver base label

TE DRAWING NO: TE40-0001 R5					PART NO: 16VAC1500MPS/6				
DESCRIPTION: AC ADAPTOR EI-48Q, 16VAC1500mA, 3 WIRE - MEPS									
SIZE	A4	DATE	30/04/09	CHECKED	KEVIN 30/04/09		ORDER REF: 0420	SHEET 1 OF 3	TOLERANCES UNLESS OTHERWISE STATED X.= +/- .X.= +/-0.5 .XX.= +/-0.2
UNIT	MM	DRAWN	KEVIN	APPROVED	FRANK 30/04/09	CUSTOMER: TE			
SCALE	NTS	MANU:				DATE:			



THIS DRAWING AND SPECIFICATIONS ARE THE PROPERTY OF TELEPHONE EQUIPMENT (NSW) Pty Ltd AND SHALL NOT BE REPRODUCED OR USED IN ANY MANNER WITHOUT THE PRIOR WRITTEN CONSENT OF TELEPHONE EQUIPMENT (NSW) Pty Ltd

ITEM	SPECIFICATION	
1. Primary rated input voltage	AC240V 50Hz 133mA	
2. Secondary rated output voltage and current	Unloaded voltage: AC 18 V ± 5% Loaded Voltage : AC 16 V ± 5% AT 1500 mA	
3. Ripple voltage	*** mV (RMS) MAX. AT Rated Loading	
4. Insulation resistance	Primary - secondary: DC 500 V 100 MΩ Min	
5. Dielectric withstand test	Primary - secondary: AC 3.64 KV 1 seconds	
6. Temperature rise	At rated loading 90°C max. For input coil (By resistance method) and 55°C max. on case surface (By use of thermometer)	
7. EFFICIENCY	≥ 79%	
8. Leadout	Primary	SAA PLUG IN TYPE
	Secondary	PVC cable length: 1.8 Meter Colour : GREY (RAL7035) Wire size: AWG#20/3C Plug : STRIPPED AND TINNED
9. Test circuit		
10. Case	SAA48 colour = GREY (RAL7035)	

	REVISED	DRAWN	APPROVED
①	AMENDED PACKING QTY AND CARTON SIZE	JACKY 10/08/09	GARY 10/08/09
②	ADDED DATE CODE ON CASE AND DIMENSIONS	JACKY 07/12/09	GARY 07/12/09
③	ADDED PASSED LABEL ON CARTON	TODD 22/12/10	JACKY 22/12/10
④	AMENDED AC PINS DIMENSION & ADDED WIRES COLORS	ANLEI 01/11/12	ANLEI 01/11/12
⑤	CHANGED CROSS-SHAPED SCREW TO SHAPE SCREW ON CASE	MARK 31/08/15	FREDERICK 31/08/15

TE DRAWING NO: TE40-0001 R5

PART NO: 16VAC1500MPS/6

DESCRIPTION: AC ADAPTOR EI-48Q,16VAC1500mA, 3 WIRE - MEPS



THIS DRAWING AND SPECIFICATIONS ARE THE PROPERTY OF TELEPHONE EQUIPMENT (NSW) Pty Ltd AND SHALL NOT BE REPRODUCED OR USED IN ANY MANNER WITHOUT THE PRIOR WRITTEN CONSENT OF TELEPHONE EQUIPMENT (NSW) Pty Ltd

SIZE	A4	DATE	30/04/09	CHECKED	KEVIN 30/04/09		ORDER REF:	0420	SHEET 2 OF 3	TOLERANCES UNLESS OTHERWISE STATED X.= +/- .X= +/-0.5 .XX= +/-0.2
UNIT	MM	DRAWN	KEVIN	APPROVED	FRANK 30/04/09		CUSTOMER:	TE		
SCALE	NTS	MANU:				DATE:				

	REVISED	DRAWN	APPROVED
①	AMENDED PACKING QTY AND CARTON SIZE	JACKY 10/08/09	GARY 10/08/09
②	ADDED DATE CODE ON CASE AND DIMENSIONS	JACKY 07/12/09	GARY 07/12/09
③	ADDED PASSED LABEL ON CARTON	TODD 22/12/10	JACKY 22/12/10
④	AMENDED AC PINS DIMENSION & ADDED WIRES COLORS	ANLEI 01/11/12	ANLEI 01/11/12
⑤	CHANGED CROSS-SHAPPED SCREW TO SHAPE  SCREW ON CASE	MARK 31/08/15	FREDERICK 31/08/15

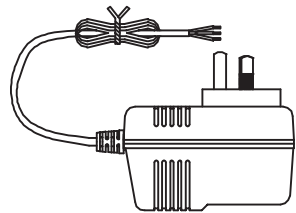

1 PC/WHITE BOX

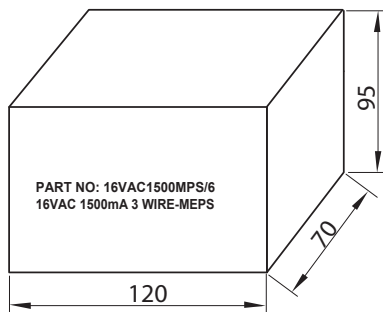
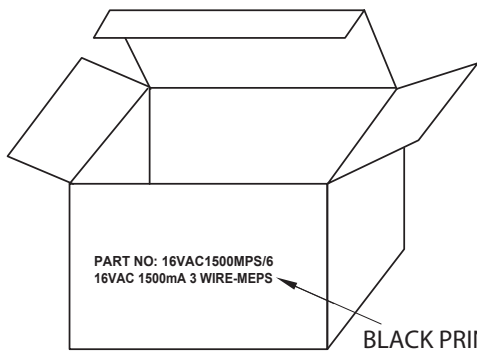

20 BOXES/CARTON ①

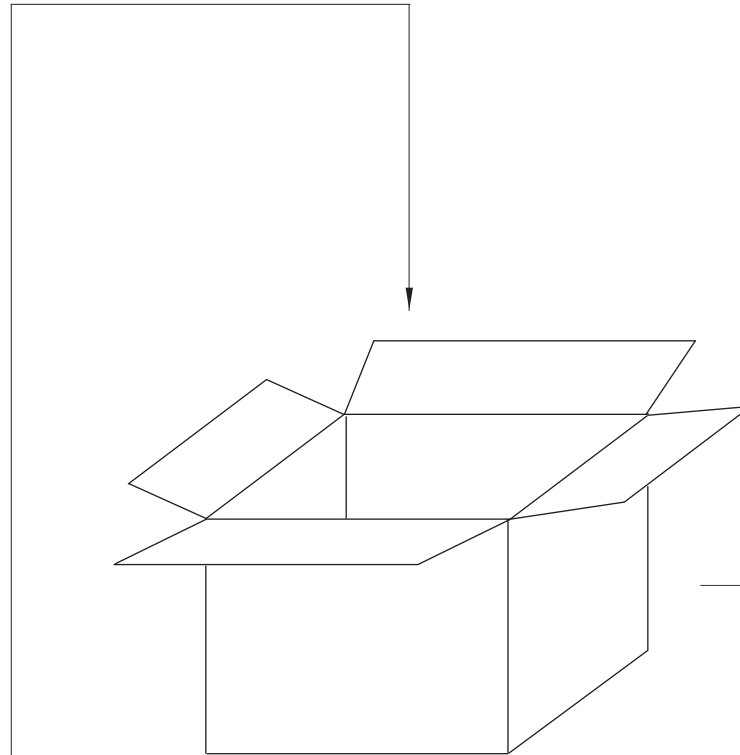

SHIPPING CARTON
PLEASE FOLLOW ORDER TO PRINT SHIPPING MARKS.

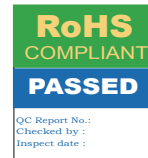
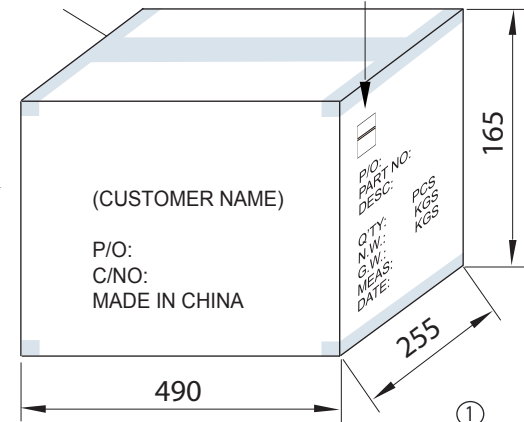

③

ONLY ONE RoHS+PASSED LABEL ON CARTON
RoHS LABEL(5X25MM)
GREEN GROUNDING YELLOW TEXT
PASSED LABEL(5X36MM)
BLUE GROUNDING WHITE TEXT
WHITE GROUNDING BLUE TEXT

TE DRAWING NO: TE40-0001 R5 PART NO: 16VAC1500MPS/6

DESCRIPTION: AC ADAPTOR EI-48Q,16VAC1500mA, 3 WIRE - MEPS



THIS DRAWING AND SPECIFICATIONS ARE THE PROPERTY OF TELEPHONE EQUIPMENT (NSW) Pty Ltd AND SHALL NOT BE REPRODUCED OR USED IN ANY MANNER WITHOUT THE PRIOR WRITTEN CONSENT OF TELEPHONE EQUIPMENT (NSW) Pty Ltd

SIZE	A4	DATE	30/04/09	CHECKED	KEVIN 30/04/09		ORDER REF:	0420	SHEET 3 OF 3	TOLERANCES UNLESS OTHERWISE STATED X.= +/-1 .X.= +/-0.5 .XX.= +/-0.2
UNIT	MM	DRAWN	KEVIN	APPROVED	FRANK 30/04/09		CUSTOMER:	TE		
SCALE	NTS	MANU:					DATE:			



Specifications TELLC0280

The TELLC0280 is the telephone lead with 606 Socket and 2 Meter length of Telephone Cord.

Colour: Ivory.

