



Specifications PRXMG5050+-V74

The PRXMG5050+-V74 is a Magellan 32-Zone Wireless Transceiver Control Panel.

Features:

- 2 serial outputs master/slave
- M2 two-way FSK hardware ready
- 8 on-board zones (16 with ATZ)
- Built-in transceiver (433 MHz)
- Expandable to 32 zones, 2 partitions, 32 users and 32 remotes
- 4-wire communication bus (connect up to 15 modules)
- Supports IP and cellular IP reporting
- Supports 16 PGMs (any of which can be wireless)
- App-based system control via BlueEye
- In-field firmware upgrade via 307USB And BabyWare remote or local
- Menu-driven programming for the Installer, Master and Maintenance codes
- Multiple telephone numbers for event reporting: 3 monitoring and 5 for Personal Dialing
- Calendar with Daylight savings Time
- StayD Mode
- Sleep arming method
- RF Jamming Supervision
- 512 events buffered.

P ▲ R ▲ D O X™



Specifications PRX278000033-P2C

The PRX278000033-P2C is a metal box enclosure for provision multiple module and panel mounting.

Features:

- Many punch-out holes for simple wiring
- Easy door removal
- Sizes: 28cm X 28cm X 7.6cm (11" x11" x 3")

P ▲ R ▲ D O X™



Specifications PRXK-TK278

The PRXK-TK278 is a BOM Kit for 1x tamper switch PRX2502302000-P2C and 1x tamper bracket PRX2781030000-P2C to suit with Paradox Metal Box Enclosure PRX2780000033-P2C; to protect against tampering (opening door or removal from wall).

P ▲ R ▲ D O X™

SP5500+ / SP6000+ / SP7000+ User Guide

4 to 32-Zone Expandable Security Systems



P ▲ R ▲ D O X™

TM50 (5") / TM70 (7")

Touch Screen Keypads



TM50 / TM70

The TM50 / TM70 are touch screen input keypads designed to communicate with Paradox control panels, and offer user friendly interface. Both offer vivid colors and two sizes to select, 7" – TM70 or 5" – TM50.

The TM70 due to its larger screen allows for more information to be displayed on one screen and is more convenient in comparison to the TM50.

Both touch screen displays are compatible with Spectra, Magellan and EVO Paradox systems, and both support Paradox next generation Swan panels with RS-485 fast encrypted bus, and features like complete menu programming, remote keypad firmware upgrade and screen saver images download from the Insite GOLD application.

The TM70 / TM50 have screen savers with auto mode, adjustable brightness with auto dim mode and full dark sleep mode, indoor temperature display, bus voltage monitoring and easy multi-partition control.

The TM70 LCD color display resolution is 800 x 400 pixels while the TM50 resolution is 472 x 272 pixels. Both come with an external SD media card (4 GB), 2 GB free space for uploading jpegs for screen savers.

The TM70 is offered in white and the TM50 in white or black colors, other colors may be custom ordered.

Features

- ▶ 7" (TM70) / 5" (TM50) with vivid color display
- ▶ Compatible with Swan, EVO, Spectra and Magellan
- ▶ Built-in zone input
- ▶ Customizable labels (zones, partitions, users, doors and PGMs)
- ▶ External SD Media Card slot (4 GB with 2 GB of free space) for uploading photos; acts like a digital picture frame
- ▶ Firmware upgradable via SD card
- ▶ Indoor temperature reading
- ▶ In-wall bracket (optional)



TM70 installed with in-wall optional bracket

Technical Specifications

	TM70	TM50
Power Input	9 to 15 VDC	
Consumption	250 mA at max brightness + 80 mA sounder	150 mA at max brightness, +80 mA sounder
Wire Connection	18 Gauge	22 Gauge, 18 Gauge recommended
Display	7" 800 x 480	5" 480 x 272
Dimensions	17.7 x 11.4 x 1.5 cm (7 x 4.5 x 0.6 in.)	14.2 x 9.5 x 1.4 cm (5.6 x 3.75 x 0.56 in.)
Humidity	5-90%	
Indoor Temperature	Yes	
SD Card	4 GB; 2 GB free	
Input	Zone, configurable	
Tamper	Built-in, cover and wall	
Compatibility	Swan, EVO, Spectra, Magellan	
Remote Upgrade	Swan only	
Jpeg Download	Swan via Bus, EVO/Spectra SD Card	
Auto Dim	Yes	
Chime	Yes	



P ▲ R ▲ D O X™

TTM70-G2K rev.04 - Printed in Canada 04/2019.
 Specifications may change without prior notice. US, Canadian and international patents may apply. Paradox is a trademark or registered trademark of Paradox Security Systems (Bahamas) Ltd. or its affiliates in Canada, the United States and/or other countries. © 2019 Paradox Security Systems Ltd. All rights reserved.



www.paradox.com



Specifications DFMSC03/CO/TOP

The DFMSC03/CO/TOP is the siren cover kit.

This siren cover kit comes with:

- UV treated plastic cover
- Combo Siren/Horn, 8 Ω /15W
- LED Strobe (Water-proof), 50mA
- Reed tamper switch
- Top hat piezo, 90mA @ 105dB
- 7-Way terminal block (pre-wired)

Total current draw for DFMSC03/CO/TOP is 590mA.

Operating voltage is 12VDC.

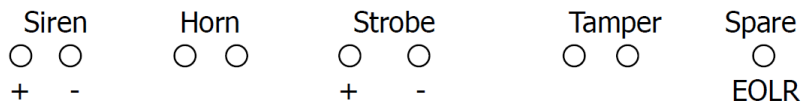



VRLA 12V7AH

SA12V7

Specifications

Nominal Voltage	12 V	
Nominal Capacity 20HR	7.0 AH	
Dimensions	Length	151±1mm (5.94 inches)
	Width	65±1mm (2.56 inches)
	Container Height	95±1mm (3.74 inches)
	Total Height (with terminal)	100±1mm (3.94 inches)
Approx Weight	Approx 2.10 kg (4.63 lbs)	
Terminal	F1	
Container Material	ABS Plastic	
Lead Material	Purity Lead 99.995%	
Sulfuric Acid	Distilled Sulfuric Acid (Zero metal content)	
Separator	AGM	
Rated Capacity	7.00 AH/0.350A	(20hr, 1.80V/cell, 25°C/77°F)
	6.53 AH/0.653A	(10hr, 1.80V/cell, 25°C/77°F)
	6.00 AH/1.20A	(5hr, 1.75V/cell, 25°C/77°F)
	5.37 AH/1.79A	(3hr, 1.75V/cell, 25°C/77°F)
	4.55 AH/4.55A	(1hr, 1.60V/cell, 25°C/77°F)
Max. Discharge Current	105A (5s)	
Internal Resistance	Approx 23mΩ	
Operating Temp.Range	Discharge	: -15 - 50°C (5 - 122°F)
	Charge	: 0 - 40°C (32 - 104°F)
	Storage	: -15 - 40°C (5 - 104°F)
Nominal Operating Temp.Range	25±3°C (77±5°F)	
Cycle Use	Initial Charging Current less than 2.1A. Voltage 14.4V - 14.7V at 25°C (77°F) Temp.Coefficient -30mV/°C	
Standby Use	No limit on Initial Charging Current Voltage 13.5V - 13.8V at 25°C (77°F) Temp.Coefficient -20 mV/°C	
Capacity affected by Temperature	40°C (104°F) 103% 25°C (77°F) 100% 0°C (32°F) 86%	
Self Discharge	Sentry AGM series batteries may be stored for up to 6 months at 25°C (77°F) and then a freshening charge is required. For higher temperatures the time interval will be shorter.	



Applications

- All purpose
- Standby Applications
- Recreation Vehicles
- Uninterruptible Power Supply (UPS)
- Electric Power System (EPS)
- Fire & Security
- Generators
- Medical Equipment

Dimensions

F1 Terminal

Unit: mm (inches)

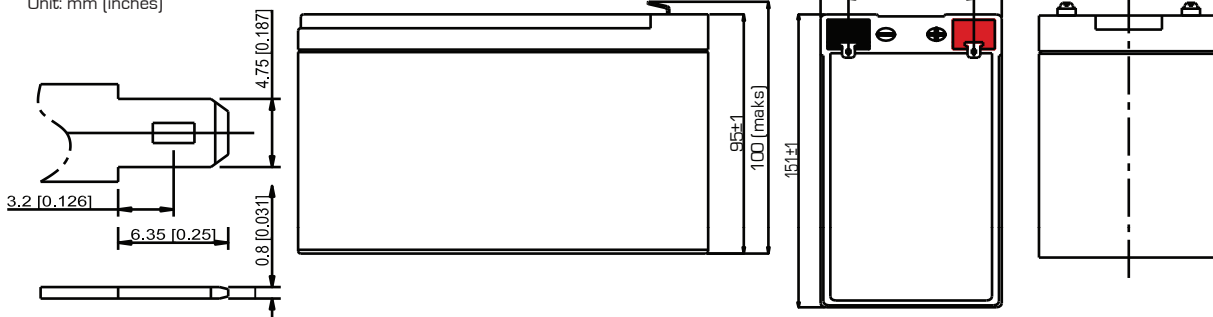

Constant Current Discharge (Amperes) at 25°C (77°F)

F.V./Time	5min	10min	15min	20min	30min	45min	1h	2h	3h	4h	5h	6h	8h	10h	20h
1.85V/cell	18.0	12.8	10.48	8.79	6.53	4.79	3.86	2.29	1.69	1.36	1.14	0.98	0.774	0.640	0.345
1.80V/cell	21.4	14.3	11.4	9.44	6.94	5.05	4.03	2.38	1.74	1.40	1.17	1.01	0.791	0.653	0.350
1.75V/cell	24.2	15.6	12.2	10.0	7.29	5.27	4.18	2.45	1.79	1.43	1.20	1.03	0.805	0.663	0.357
1.70V/cell	26.7	16.7	12.9	10.5	7.59	5.46	4.32	2.51	1.83	1.46	1.22	1.05	0.817	0.672	0.361
1.65V/cell	28.8	17.7	13.5	10.9	7.86	5.62	4.46	2.57	1.86	1.48	1.23	1.06	0.826	0.680	0.365
1.60V/cell	30.6	18.6	14.1	11.3	8.09	5.76	4.55	2.61	1.89	1.50	1.25	1.07	0.834	0.685	0.367

Constant Power Discharge (Watts/Cell) at 25°C (77°F)

F.V./Time	5min	10min	15min	20min	30min	45min	1h	2h	3h	4h	5h	6h	8h	10h	20h
1.85V/cell	34.2	24.5	20.2	17.1	12.8	9.44	7.64	4.56	3.37	2.72	2.29	1.99	1.565	1.296	0.701
1.80V/cell	40.2	27.2	21.9	18.3	13.5	9.91	7.96	4.72	3.47	2.79	2.34	2.03	1.593	1.318	0.708
1.75V/cell	45.1	29.5	23.3	19.3	14.2	10.3	8.23	4.85	3.55	2.85	2.39	2.06	1.616	1.344	0.719
1.70V/cell	49.2	31.3	24.5	20.1	14.7	10.6	8.48	4.96	3.62	2.89	2.42	2.09	1.633	1.347	0.725
1.65V/cell	52.6	32.9	25.5	20.8	15.2	10.9	8.73	5.05	3.68	2.93	2.45	2.11	1.649	1.359	0.731
1.60V/cell	55.5	34.3	26.3	21.5	15.5	11.2	8.88	5.12	3.72	2.96	2.47	2.13	1.660	1.367	0.734

Discharge Characteristics

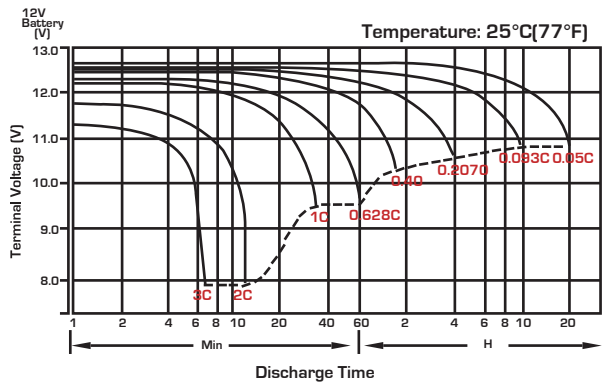

Float Charging Characteristics

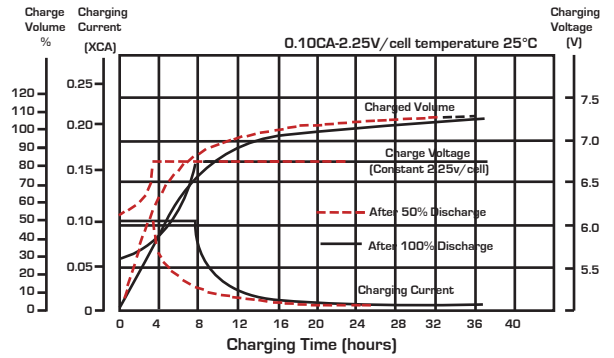

Temperature Effects in Relation to Battery Capacity

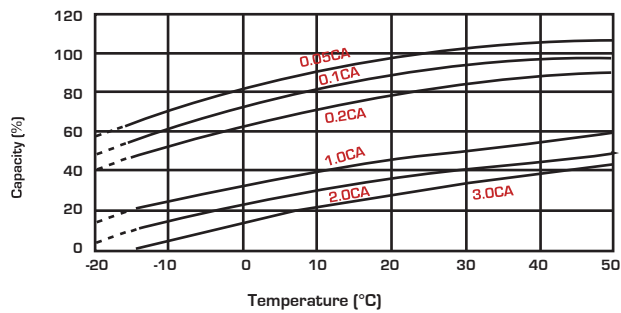

Effect of Temperature on Long Term Float Life

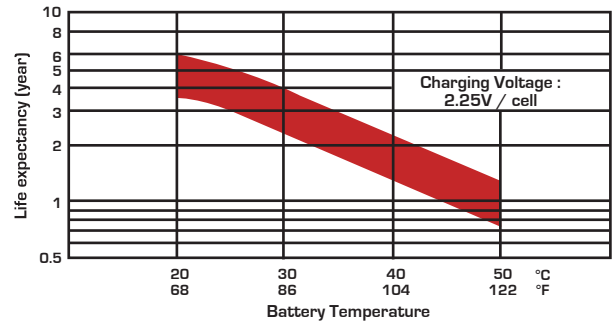

Cycle Life in Relation to Depth of Discharge

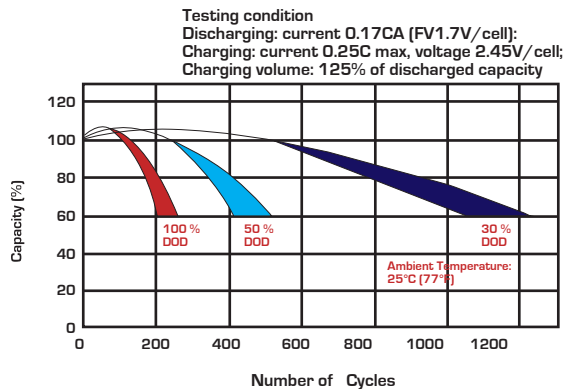

Self Discharge Characteristics

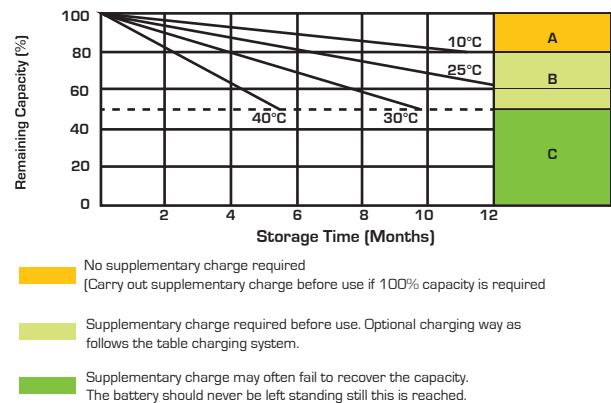

Charging System

DOD	Current Limit (A)	Constant Voltage (V)	Fully Charged Time (h)
20	0.15C ₁₀	13.5-13.8 vpc (12V)	10
	0.20C ₁₀	6.75-6.9 vpc (6V)	8
50	0.15C ₁₀	13.5-13.8 vpc (12V)	15
	0.20C ₁₀	6.75-6.9 vpc (6V)	12
80	0.15C ₁₀	13.5-13.8 vpc (12V)	16
	0.20C ₁₀	6.75-6.9 vpc (6V)	14
100	0.15C ₁₀	13.5-13.8 vpc (12V)	20
	0.20C ₁₀	6.75-6.9 vpc (6V)	18

State of Charge (SOC)

Open Circuit Voltage (V/cell)	Open Circuit Voltage (12V/cell)	Open Circuit Voltage (6V/cell)	State of Charge (% of full charge capacity)
2.14-2.15	12.84-12.90	6.42-6.46	100
2.12-2.13	12.72-12.78	6.36-6.39	90
2.11	12.66	6.33	80
2.09	12.54	6.27	70
2.07	12.42	6.21	60
2.05	12.30	6.15	50



Sealed Performance Batteries

Domestic Sales | Ph: +61 (0)7 3386 1102 | Fax: +61 (0)7 3102 9913

sales@spb.net.au | www.sealedperformance.com.au

National Warehouse | 1 Ant Road | Yatala, Brisbane QLD 4207

Melbourne Office | 2/9 Compark Circuit | Mulgrave, Melbourne VIC 3170

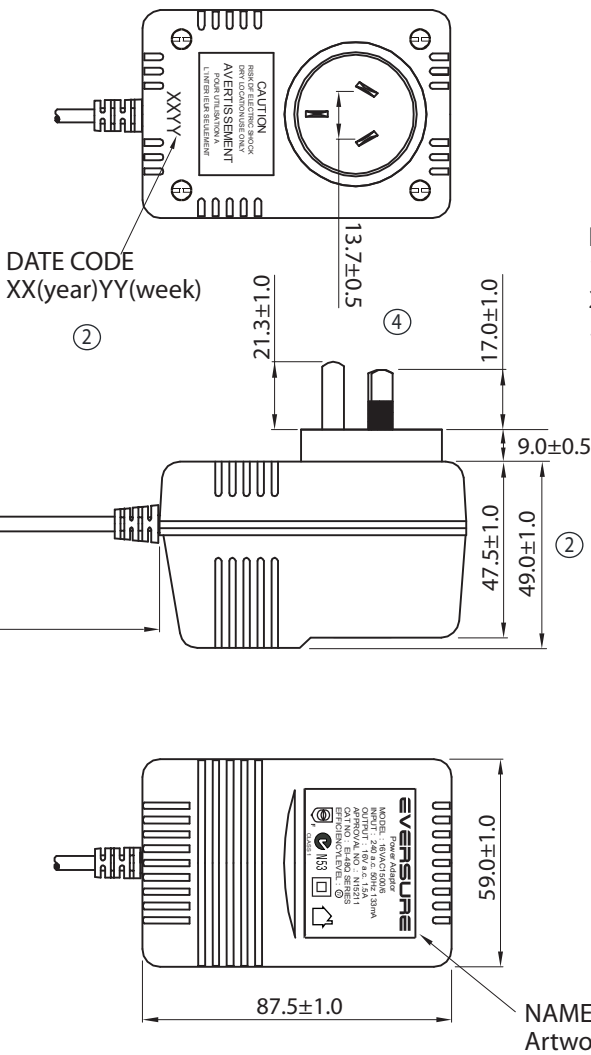
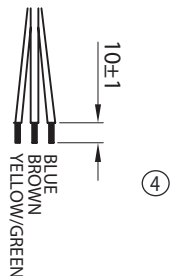

	REVISED	DRAWN	APPROVED
①	AMENDED PACKING QTY AND CARTON SIZE	JACKY 10/08/09	GARY 10/08/09
②	ADDED DATE CODE ON CASE AND DIMENSIONS	JACKY 07/12/09	GARY 07/12/09
③	ADDED PASSED LABEL ON CARTON	TODD 22/12/10	JACKY 22/12/10
④	AMENDED AC PINS DIMENSION & ADDED WIRES COLORS	ANLEI 01/11/12	ANLEI 01/11/12
⑤	CHANGED CROSS-SHAPED SCREW TO SHAPE SCREW ON CASE	MARK 31/08/15	FREDERICK 31/08/15

- NOTES:
1. OUTPUT CORD: 20AWGX3C 1.83M Lead Free GREY (RAL7035)
 2. CASE: GREY (RAL7035)
 3. SECURITY SCREW IS AN ESSENTIAL REQUIREMENT, BOTH "" AND "" SHAPE ARE ACCEPTABLE

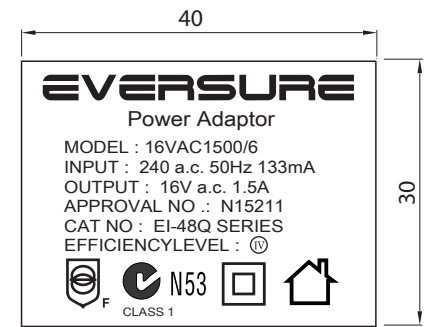

LABEL ARTWORK
Black word on Silver base label

TE DRAWING NO: TE40-0001 R5 PART NO: 16VAC1500MPS/6

DESCRIPTION: AC ADAPTOR EI-48Q, 16VAC1500mA, 3 WIRE - MEPS

SIZE	A4	DATE	30/04/09	CHECKED	KEVIN 30/04/09	ORDER REF:	0420	SHEET 1 OF 3	TOLERANCES UNLESS OTHERWISE STATED X.= +/- .X.= +/-0.5 .XX.= +/-0.2
UNIT	MM	DRAWN	KEVIN	APPROVED	FRANK 30/04/09	CUSTOMER:	TE		
SCALE	NTS	MANU:		DATE:					



THIS DRAWING AND SPECIFICATIONS ARE THE PROPERTY OF TELEPHONE EQUIPMENT (NSW) Pty Ltd AND SHALL NOT BE REPRODUCED OR USED IN ANY MANNER WITHOUT THE PRIOR WRITTEN CONSENT OF TELEPHONE EQUIPMENT (NSW) Pty Ltd

ITEM	SPECIFICATION	
1. Primary rated input voltage	AC240V 50Hz 133mA	
2. Secondary rated output voltage and current	Unloaded voltage: AC 18 V ± 5% Loaded Voltage : AC 16 V ± 5% AT 1500 mA	
3. Ripple voltage	*** mV (RMS) MAX. AT Rated Loading	
4. Insulation resistance	Primary - secondary: DC 500 V 100 MΩ Min	
5. Dielectric withstand test	Primary - secondary: AC 3.64 KV 1 seconds	
6. Temperature rise	At rated loading 90°C max. For input coil (By resistance method) and 55°C max. on case surface (By use of thermometer)	
7. EFFICIENCY	≥ 79%	
8. Leadout	Primary	SAA PLUG IN TYPE
	Secondary	PVC cable length: 1.8 Meter Colour : GREY (RAL7035) Wire size: AWG#20/3C Plug : STRIPPED AND TINNED
9. Test circuit		
10. Case	SAA48 colour = GREY (RAL7035)	

	REVISED	DRAWN	APPROVED
①	AMENDED PACKING QTY AND CARTON SIZE	JACKY 10/08/09	GARY 10/08/09
②	ADDED DATE CODE ON CASE AND DIMENSIONS	JACKY 07/12/09	GARY 07/12/09
③	ADDED PASSED LABEL ON CARTON	TODD 22/12/10	JACKY 22/12/10
④	AMENDED AC PINS DIMENSION & ADDED WIRES COLORS	ANLEI 01/11/12	ANLEI 01/11/12
⑤	CHANGED CROSS-SHAPED SCREW TO SHAPE SCREW ON CASE	MARK 31/08/15	FREDERICK 31/08/15

TE DRAWING NO: TE40-0001 R5

PART NO: 16VAC1500MPS/6

DESCRIPTION: AC ADAPTOR EI-48Q,16VAC1500mA, 3 WIRE - MEPS



THIS DRAWING AND SPECIFICATIONS ARE THE PROPERTY OF TELEPHONE EQUIPMENT (NSW) Pty Ltd AND SHALL NOT BE REPRODUCED OR USED IN ANY MANNER WITHOUT THE PRIOR WRITTEN CONSENT OF TELEPHONE EQUIPMENT (NSW) Pty Ltd

SIZE	A4	DATE	30/04/09	CHECKED	KEVIN 30/04/09		ORDER REF:	0420	SHEET 2 OF 3	TOLERANCES UNLESS OTHERWISE STATED X.= +/- .X=+/-0.5 .XX=+/-0.2
UNIT	MM	DRAWN	KEVIN	APPROVED	FRANK 30/04/09		CUSTOMER:	TE		
SCALE	NTS	MANU:				DATE:				

	REVISED	DRAWN	APPROVED
①	AMENDED PACKING QTY AND CARTON SIZE	JACKY 10/08/09	GARY 10/08/09
②	ADDED DATE CODE ON CASE AND DIMENSIONS	JACKY 07/12/09	GARY 07/12/09
③	ADDED PASSED LABEL ON CARTON	TODD 22/12/10	JACKY 22/12/10
④	AMENDED AC PINS DIMENSION & ADDED WIRES COLORS	ANLEI 01/11/12	ANLEI 01/11/12
⑤	CHANGED CROSS-SHAPPED SCREW TO SHAPE  SCREW ON CASE	MARK 31/08/15	FREDERICK 31/08/15

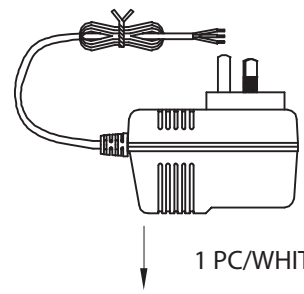

1 PC/WHITE BOX

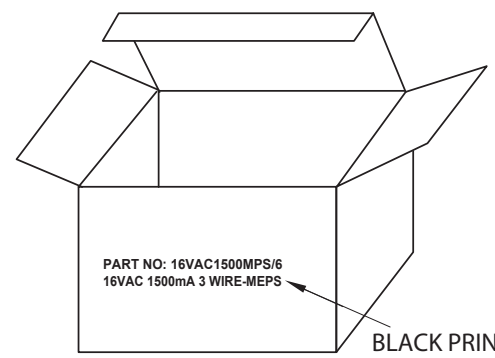

PART NO: 16VAC1500MPS/6
16VAC 1500mA 3 WIRE-MEPS

BLACK PRINTING

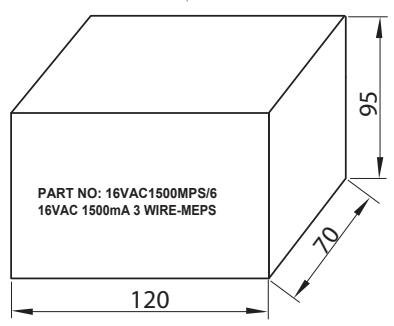

20 BOXES/CARTON ①

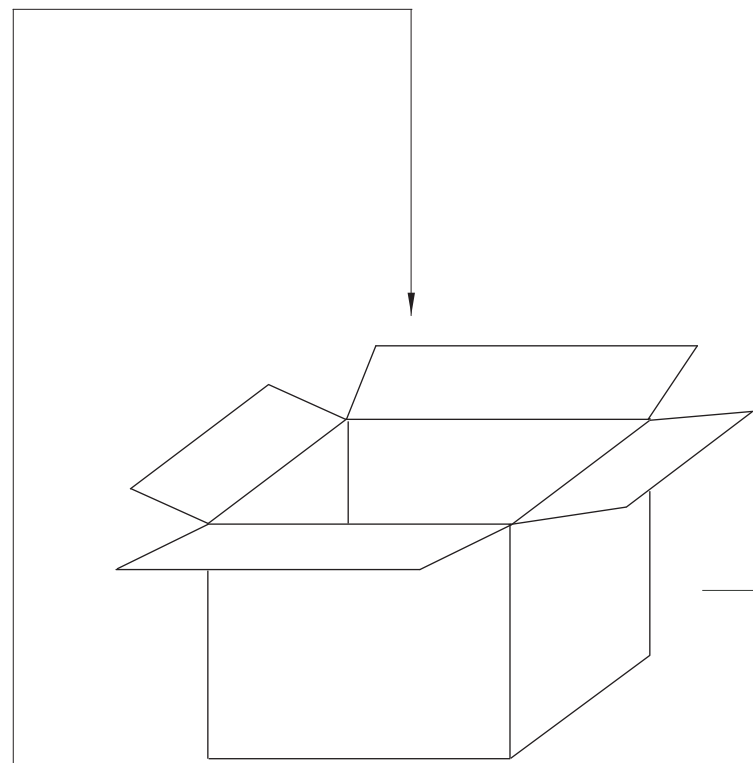

SHIPPING CARTON
PLEASE FOLLOW ORDER TO PRINT SHIPPING MARKS.

ADHESIVE TAPE

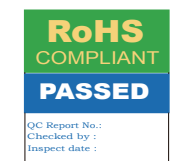
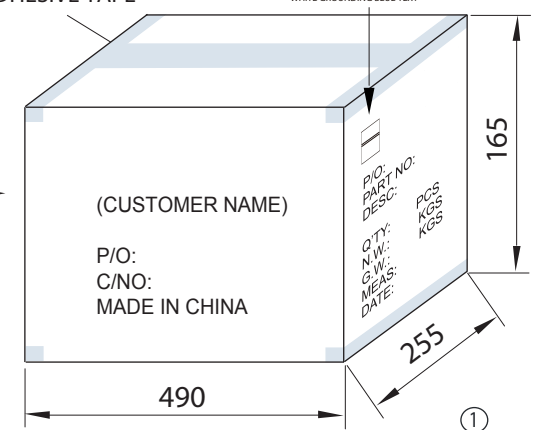

③

ONLY ONE RoHS+PASSED LABEL ON CARTON
RoHS LABEL(5X25MM)
GREEN GROUNDING YELLOW TEXT
PASSED LABEL(5X36MM)
BLUE GROUNDING WHITE TEXT
WHITE GROUNDING BLUE TEXT

①

TE DRAWING NO: TE40-0001 R5 PART NO: 16VAC1500MPS/6

DESCRIPTION: AC ADAPTOR EI-48Q,16VAC1500mA, 3 WIRE - MEPS



THIS DRAWING AND SPECIFICATIONS ARE THE PROPERTY OF TELEPHONE EQUIPMENT (NSW) Pty Ltd AND SHALL NOT BE REPRODUCED OR USED IN ANY MANNER WITHOUT THE PRIOR WRITTEN CONSENT OF TELEPHONE EQUIPMENT (NSW) Pty Ltd

SIZE	A4	DATE	30/04/09	CHECKED	KEVIN 30/04/09		ORDER REF:	0420	SHEET 3 OF 3	TOLERANCES UNLESS OTHERWISE STATED X.= +/-1 .X.= +/-0.5 .XX.= +/-0.2
UNIT	MM	DRAWN	KEVIN	APPROVED	FRANK 30/04/09		CUSTOMER:	TE		
SCALE	NTS	MANU:					DATE:			



Specifications TELLC0280

The TELLC0280 is the telephone lead with 606 Socket and 2 Meter length of Telephone Cord.

Colour: Ivory.

