

Spectra SP Series

4 to 32-Zone Expandable Security Systems

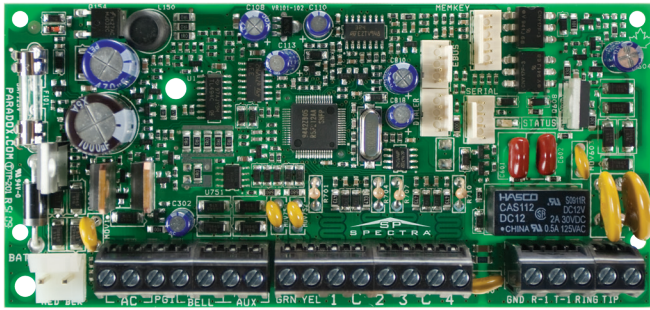

Description

Spectra SP control panels (SP4000, SP5500, SP6000, SP65, and SP7000) offer a combination of innovative features and an advanced communication bus for a uniquely expandable security system. Through its communication bus, all Spectra SP panels can be expanded via wireless and hardwired expansion modules and a variety of accessory modules. With their in-field firmware upgrade capability, the Spectra SP series allows installers to upgrade their system without hassle – quickly, easily, and on-site. To further facilitate installation, every Spectra SP panel can be configured using easy-to-follow, menu-driven programming.

Spectra SP also features multipath communication; this enables your system to communicate through multiple channels, including telephony with its built-in landline dialer, IP with the IP150 Internet Module, IP/GPRS/GSM with the PCS series module, and voice with the VDMP3 Plug-In Voice Module.

With its reliable communication technology, flexible expansion and user-friendly keypads, Spectra SP is the complete residential or commercial security solution.

Features

- Supports StayD mode
- 4-wire expansion bus
- Wireless expansion (via RTX3 / RX1)
- Expandable to 32 zones
- Expandable to 16 PGMs
- 2 partitions
- 32 user codes
- Supports PCS series modules
- Supports IP150 Internet Module
- Supports VDMP3 Plug-in Voice Module
- Supports REM3 Hand-held Remote Keypad
- Supports SR150 Wireless Siren
- Landline dialer (except SP65)
- In-field firmware upgradable

System Overview

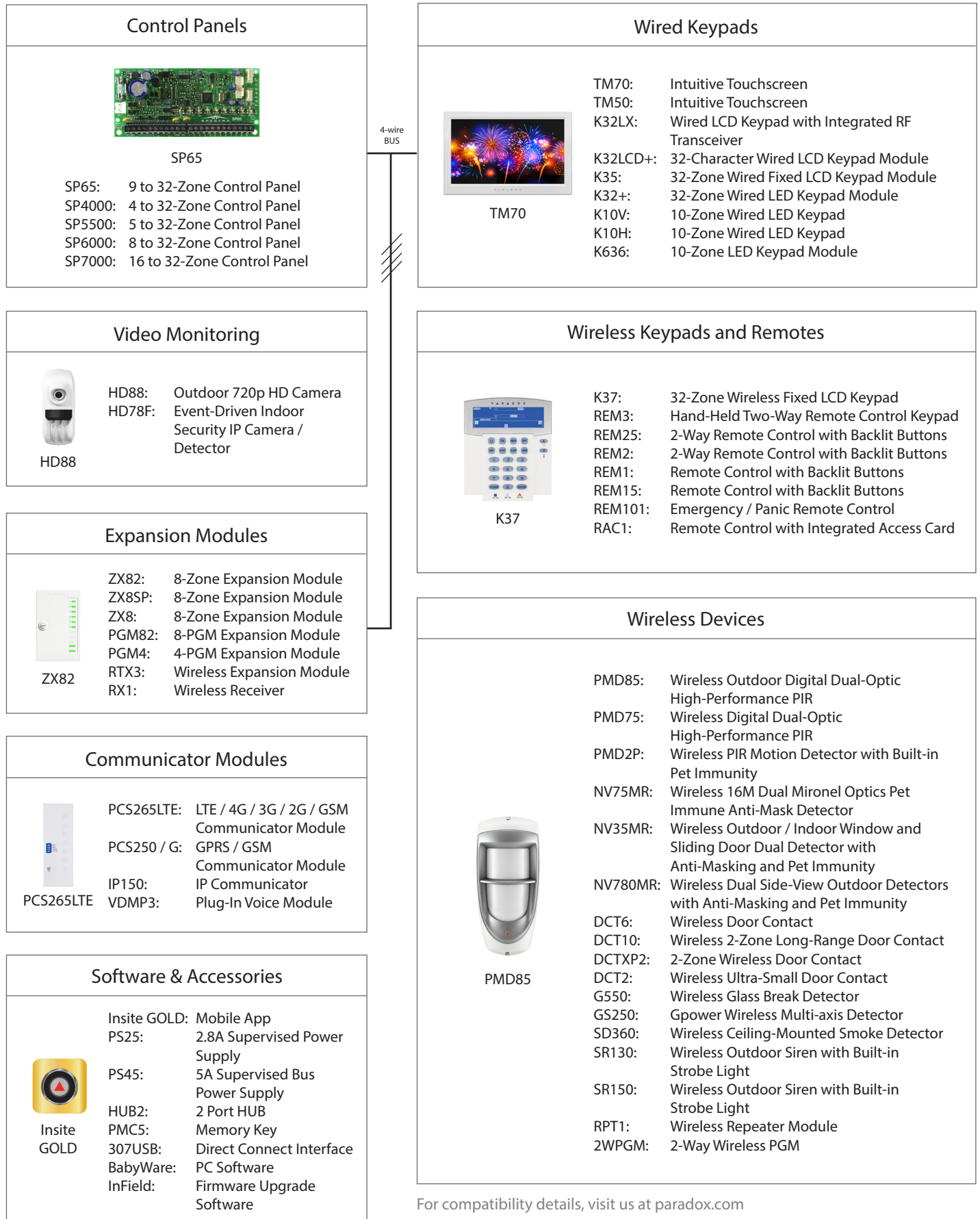

Feature Details



Internet Communication (IP150)

The IP150 Internet Module allows you to control and monitor your security system remotely through any web browser. It allows for email notifications of important system events such as alarms, arm/disarm events, and troubles. For example, receive an email at work when your kids get back from school. Also, view the live status of your system and arm/disarm it. For instance, you have just left your office for the weekend but are unsure whether you armed the system. Simply check the status of your system from a laptop and arm it.



Wireless Communication (PCS Series)

The PCS series modules provide the Spectra SP control panels with wireless communication capabilities to report system events via IP, GPRS, and/or GSM. Whether it be uploading/downloading via IP or GPRS, receiving system status and events by voice or text message, or reporting to the monitoring station via IP, GPRS, or GSM, the PCS series enhances the communication capabilities of any Spectra SP installation.



Voice Communication (VDMP3)

The VDMP3 is a plug-in, voice-assisted module that can be programmed to call up to five telephone numbers in the event of an alarm. For example, when an alarm occurs at your store during off-hours, every employee can receive notification via telephone. You can also call the VDMP3 from an outside line, enabling you to arm or disarm the system as well as activate PGMs. The VDMP3 essentially turns any outside telephone into a keypad. The VDMP3 is easy to install; plug it in directly onto the panel, set the phone numbers, and select the activation event.



StayD

StayD resolves all issues with common security systems and represents the only solution for secure living. The revolutionary StayD feature represents a completely reversed philosophy compared to all other security systems made today. Traditional systems share the same principle - in order to provide security, users must remember to arm the system; otherwise the system is disarmed and does not provide security. A StayD system is always armed, and needs only to be partly disarmed when an entry or exit is needed. With StayD, you can truly have peace of mind knowing, that you are always protected.



In-field Upgradable

Spectra SP is not only easy to install, but is also fully in-field upgradable, allowing for simple on-site updates. The process is effortless; connect the PC to the panel and you are a few clicks away from performing a complete system upgrade within minutes. No need to change panels or hardware; all the updates are performed using Paradox's InField Firmware Upgrade Software.



App-based System Control

The Insite GOLD app enables you to remotely access your Paradox security system and view your system cameras. Insite GOLD provides lots of functionality and information at one's fingertip. It has an intuitive user-interface which enables you to easily connect to your security system and edit settings. Now you can control your Paradox security system from any Android / iOS smartphone.

TM70 Overview



TM70: Intuitive Touchscreen

- ## SpotOn Locator™

Upload photos, images, or schematics to eliminate the need for deciphering LED zone lights. These images display any door, window, or motion detector that are active. Since the images are uploaded by the user, they are truly customized, and can be unique to each installation. SpotOn Locator™ is integrated in the original firmware, and when purchased, is unlocked with an authorization code.

- ## OneScreen Monitoring™

Provides a real-time visual display of the system's status on one screen. It allows the user to choose which partitions will be displayed showing arming level, alarm, ready, and troubles. It also displays zone statuses; open, close, bypass, alarm, and tamper. OneScreen Monitoring™ also features Solo Test™ mode, which allows installers and users to easily test all system zone's via the TM70 Touch's screen. OneScreen Monitoring™ is integrated in the original firmware, and when purchased, is unlocked with an authorization code.

Specifications

Display	16-bit, color LCD; 8.6 x 15.4 cm (3.1 x 5.9 in.), 800 x 480 pixels
Input Voltage	9 to 15 Vdc
Current Consumption	250 mA at max brightness + 80 mA sounder
Keypad Zone Input	1 for a detector or external temperature sensor
Tamper	Built-in, cover and wall
Humidity	5 to 90%
Operating Temperature	-10 to 55 °C (14 to 131 °F)
Compatibility	Swan, EVO, Spectra, Magellan

Note: All control panel outputs are rated to operate between 11.4 Vdc and 12.5 Vdc.



Specifications PRX278000033-P2C

The PRX278000033-P2C is a metal box enclosure for provision multiple module and panel mounting.

Features:

- Many punch-out holes for simple wiring
- Easy door removal
- Sizes: 28cm X 28cm X 7.6cm (11" x11" x 3")

P ▲ R ▲ D O X™



Specifications PRXK-TK278

The PRXK-TK278 is a BOM Kit for 1x tamper switch PRX2502302000-P2C and 1x tamper bracket PRX2781030000-P2C to suit with Paradox Metal Box Enclosure PRX2780000033-P2C; to protects against tampering (opening door or removal from wall).

P ▲ R ▲ D O X™

SP5500+ / SP6000+ / SP7000+ User Guide

4 to 32-Zone Expandable Security Systems



P ▲ R ▲ D O X™

525DM: Microwave and Infrared Digital Anti-mask Motion Detector V2.4 P ▲ R ▲ D O X™

Description

The 525DM is a microwave and infrared digital motion detector featuring anti-masking detection. It features both a microwave sensor and a passive infrared sensor, and includes Paradox's powerful signal processing algorithms for triggering an anti-masking alarm when certain conditions occur.



With the anti-masking feature, the 525DM will detect attempts to blind the detector by placing objects in its field of view or spraying it with paint etc., enhancing the level of your site's security.

Installation

There are two mounting methods that can be used for the 525DM; corner mount and flat surface mount. To install the 525DM:

- 1) Select the detector's location. Avoid placing the detector in proximity to the following sources of interference: reflective surfaces, direct air flow, sources of steam/oil vapor, infrared light sources and objects causing temperature changes. Digital microwave detection will be hampered if installed close to vibrating metal surfaces, rotating fans, water flow in plumbing pipes or electromagnetic sources. Also note, microwave frequencies can penetrate walls, therefore, avoid installing the unit where it can respond to motion on the other side of the protected area's walls. Using a Paradox standard lens at the recommended installation height of 2.1m (7ft) ±10%, the 525DM detector will provide full coverage from 1.5m (5ft) to 12m (40ft) without any dead zones (see Figure 1: *Beam Pattern*).
- 2) Remove the front cover screw holding the cover in place; open the cover.
- 3) Loosen the screw holding the PCB in place and gently slide and lift from back cover.
- 4) Drill or punch out the selected knockout holes from the 525DM back cover (as shown in Figure 2: *Installation*) and mount the back cover using the appropriate screws.
- 5) Wire the unit as shown in Figure 3: *PCB Connection*.
- 6) Perform a walk-test to verify detector coverage (see *Walk-testing*).

WARNING: Do not touch the sensor surface as this could result in a detector malfunction. If necessary, clean the sensor surface using a soft cloth with pure alcohol.

Features

- Digital microwave/infrared detection
- Anti-mask feature allows for the detection of close proximity movements (less than 0.75m / 2.5ft) within the detector range
- Adjustable microwave range
- Two auto pulse settings; one for typical environment (normal), and one for high false alarm rejection (high)
- Installer Test Mode: test microwave and infrared detection individually
- 12m (40ft) X 12m (40ft); 90° viewing angle

Figure 1: Beam Pattern

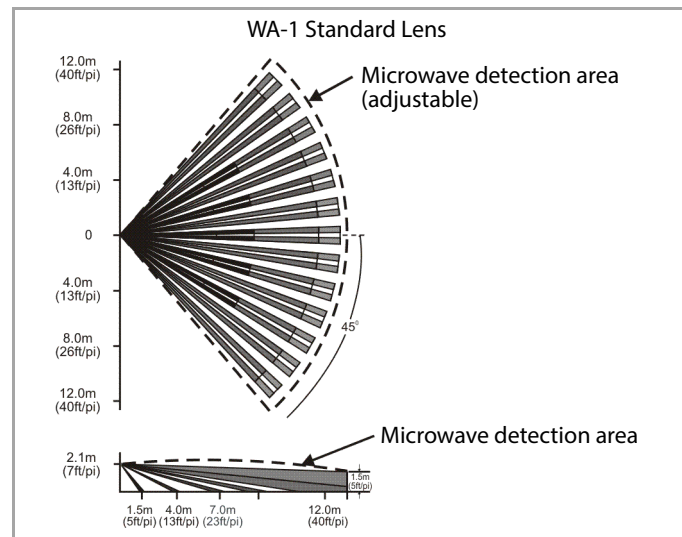

Figure 2: Installation

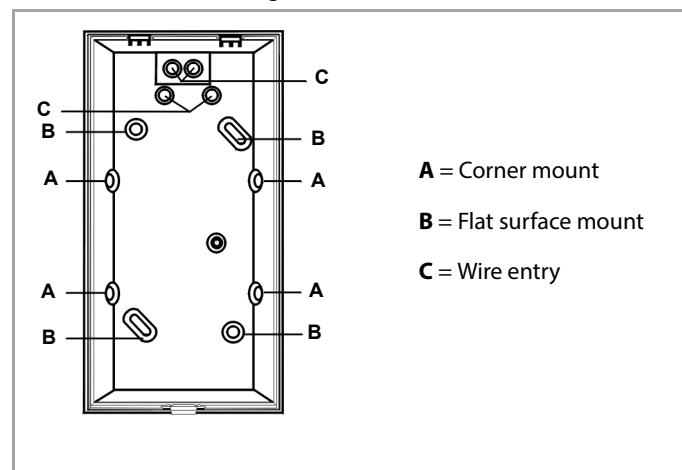
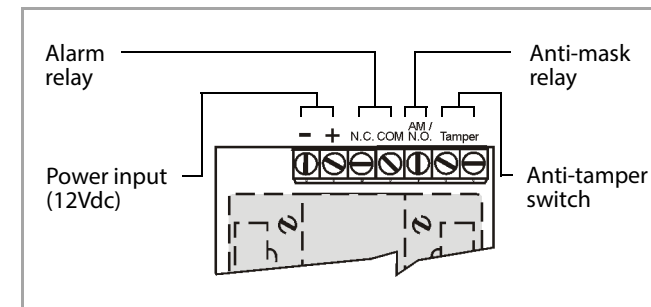

Figure 3: PCB Connection



Turning on the 525DM

Turning on the detector initiates a self-testing program for the signal processor and memory. The LEDs will flash for 16 seconds. When the LEDs are no longer flashing, the detector is ready and fully operational.

Walk-testing

At 20°C (68°F), at the highest sensitivity level, with APSP set to *normal*, and in dual-edge processing mode, you should be detected crossing at least one complete zone (consisting of 2 beams, left and right sensor detecting elements) in the coverage area with any kind of movement; slow/normal walking or running.

With APSP set to *high*, the amount of movement required to generate an alarm is doubled, and you should be detected within crossing 2 complete zones. The approximate width of a full beam at 12m (40ft) from the detector is 1.8m (6ft). To walk-test, move across the detection path, not toward the detector.

Anti-mask Detection Details

Anti-masking is active only if a valid movement detection occurred during the 10 minutes prior to the anti-mask detection. When a moving object gets near the detector, the blue LED starts flashing for 90 seconds (AM relay not activated yet). If an alarm occurs during that period, the LED stops flashing and no anti-mask trouble occurs. If no alarm occurs within that 90 seconds, anti-mask trouble occurs – AM relay is activated and the LED turns steady blue ON. The anti-mask trouble is cleared by an alarm event.

Relay Operation Details

When anti-masking is enabled, both the alarm and anti-mask relay are independent. When anti-masking is disabled, both relays are activated by an alarm, where the anti-mask relay functions as N.O., and the alarm relay functions as N.C. In *Installer Test Mode* (see reverse page), the alarm relay is continuously activated, and the anti-mask relay is activated upon an alarm. For connection details, see Figure 4: *AM Relay Output Connection*.

Figure 4: AM Relay Output Connection

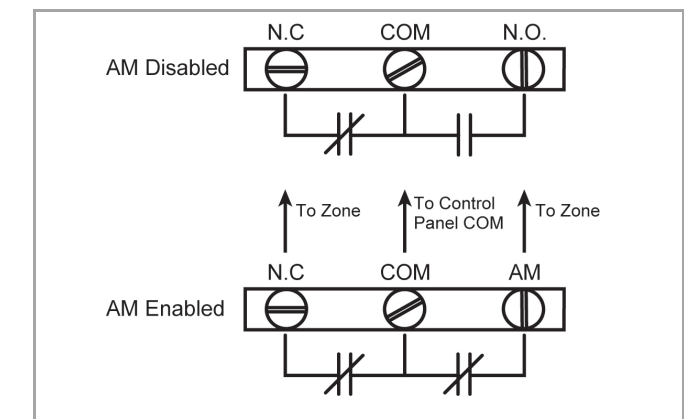

LED Indicator (Normal Operation)

LED State	Description
Red - 4 seconds	Alarm (movement detection)
Blue - Flashing 90 sec.	Anti-mask detection pending*
Blue - ON	Anti-mask detection*
Green - 0.5 seconds	Microwave detection
Yellow - 0.5 seconds	Infrared detection

*See Anti-mask Detection Details for more information.

LED Indicator (Installer Test Mode)

LED State	Description
Yellow - 4 seconds	Infrared detection
Green - 4 seconds	Microwave detection



Detector Settings

The following detector settings can be modified using the unit's DIP switches (see Figure 5: Overview). Any changes that are made to DIP switch settings are ignored during a movement alarm or an anti-mask detection. To ensure that new DIP switch settings have been registered, ensure that the unit is not in anti-mask alarm, then move out of the unit's detection path and wait for the LED to turn OFF.

Step	DIP / Trimpot	Details
1 Operational Mode		The 525DM uses both infrared and microwave detection. Setting DIP switch 1 to OFF will allow you to test each detection method individually. This feature is used in conjunction with DIP switch 3 Installer Test Mode
	DIP Switch 1	DIP switch 1 OFF = installer test mode (see step 3) DIP switch 1 ON = operational mode Δ
2 LED Settings		If DIP switch 2 is turned ON, the LED will indicate detections as per the <i>LED Indicator</i> table.
	DIP Switch 2	DIP switch 2 OFF = LED disabled DIP switch 2 ON = LED enabled Δ
3 Anti-Mask		When DIP switch 3 is turned ON, the anti-mask feature will detect close proximity movements (less than 0.75m / 2.5ft) within the detector range. NOTE: For the anti-mask feature to be enabled, DIP switch 1 must be ON.
	DIP Switch 3	DIP switch 3 OFF = anti-mask disabled DIP switch 3 ON = anti-mask enabled Δ
Installer Test Mode	DIP Switch 3	DIP switch 3 OFF = test infrared only DIP switch 3 ON = test microwave only For test mode LED feedback, see LED Indicator (Installer Test Mode) . NOTE: In installer test mode, relay functions and anti-mask are deactivated or altered.
	(with DIP1 OFF)	
4 Edge Processing Mode		Preferably, dual edge processing should be used at all times. Dual edge processing requires balanced detection from both sensor's elements and requires that a beam must be fully crossed even at close range. This setting provides better false alarm rejection. Single edge setting allows for faster detection of close range movements. Use this setting only in normal environments with minimal sources of interference. Never use single edge setting if the detector is placed near sources of interference that could adversely affect it.
	DIP Switch 4	DIP switch 4 OFF = single edge DIP switch 4 ON = dual edge Δ
5 Auto Pulse Signal Processing Level		APSP measures the energy from each detected signal and stores it in memory. To generate an alarm, the memory must reach a required minimum level. APSP can be set to <i>normal level</i> or <i>high level</i> . When APSP is set to <i>normal level</i> , the unit is calibrated to detect the energy level which is typical to crossing one full single beam at the maximum detection distance. When APSP is set to <i>high level</i> , the unit is calibrated to detect the energy level which is typical to crossing two full beams at the maximum detection distance. Set APSP to <i>high level</i> when the detector is installed in high-risk environments (potential interference) and to provide greatly increased false alarm immunity.
	DIP Switch 5	DIP switch 5 OFF = APSP - normal level Δ DIP switch 5 ON = APSP - high level
8 Microwave Range Trimpot		Microwaves generated by the unit can pass through walls and have the potential to interfere with the performance of other 525DM units. The range of the microwaves emitted by the detector can be adjusted using the trimpot (see Figure 5: Figure 5: Overview). Microwave trimpot adjustment can be verified using <i>microwave only</i> test mode.
	Trimpot	Turn clockwise = increase microwave range Turn counterclockwise = decrease microwave range WARNING: The trimpot is fragile. Do not over-torque.

Δ = default settings

Figure 5: Overview

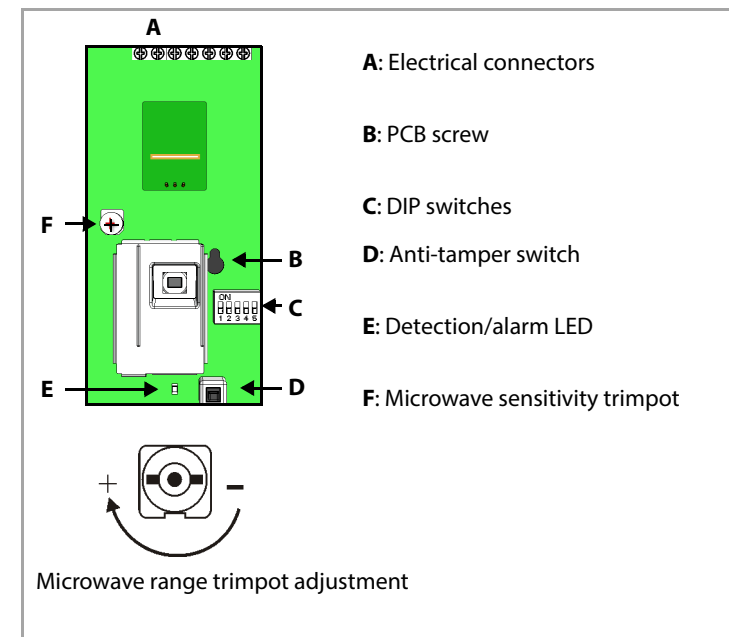

Technical Specifications

Motion detector type	PIR + Microwave
PIR sensor element type	Dual elements
PIR sensor geometry	Rectangular
Range (90° standard lens)	12m x 12m (40ft x 40ft)
Microwave antenna type	Flat strip microwave antenna with FET oscillator
Frequency	FCC & DOC - 10.525GHZ (other frequencies available)
Operating temperature	-20° to +50°C (-4° to +122°F)
Voltage	10 - 16Vdc
Current consumption	30mA (approximately)
Alarm form A output	Standard 100mA, 28Vdc
Alarm solid-state output	N.C. 150mA, 28Vdc
Tamper form C output	N.C. 150mA
Alarm period	4 seconds
Detection speed	0.2m to 3.5m/s (0.6ft to 11.5ft/s)

Warranty

© 2020 Paradox Ltd. All rights reserved. Specifications may change without prior notice. One or more of the following US patents may apply: 7046142, 6215399, 6111256, 6104319, 5920259, 5886632, and RE39406 and other pending patents may apply. Canadian and international patents may also apply. LODIFF® lens: patent #4,787,722 (U.S.). Digital Vision is a trademark or registered trademark of Paradox Ltd. or its affiliates in Canada, the United States and/or other countries. LODIFF® is a registered trademark of Fresnel Technologies Inc. For the latest information on products approvals, such as UL and CE, please visit www.paradox.com.

Warranty: For complete warranty information on this product please refer to the Limited Warranty Statement found on the website www.paradox.com/terms. Your use of the Paradox product signifies your acceptance of all warranty terms and conditions.



Specifications DFMSC03/CO/TOP

The DFMSC03/CO/TOP is the siren cover kit.

This siren cover kit comes with:

- UV treated plastic cover
- Combo Siren/Horn, 8 Ω /15W
- LED Strobe (Water-proof), 50mA
- Reed tamper switch
- Top hat piezo, 90mA @ 105dB
- 7-Way terminal block (pre-wired)

Total current draw for DFMSC03/CO/TOP is 590mA.

Operating voltage is 12VDC.

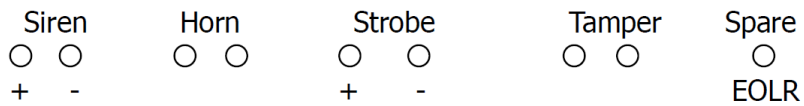



VRLA 12V7AH

SA12V7

Specifications

Nominal Voltage	12 V	
Nominal Capacity 20HR	7.0 AH	
Dimensions	Length	151±1mm (5.94 inches)
	Width	65±1mm (2.56 inches)
	Container Height	95±1mm (3.74 inches)
	Total Height (with terminal)	100±1mm (3.94 inches)
Approx Weight	Approx 2.10 kg (4.63 lbs)	
Terminal	F1	
Container Material	ABS Plastic	
Lead Material	Purity Lead 99.995%	
Sulfuric Acid	Distilled Sulfuric Acid (Zero metal content)	
Separator	AGM	
Rated Capacity	7.00 AH/0.350A	(20hr, 1.80V/cell, 25°C/77°F)
	6.53 AH/0.653A	(10hr, 1.80V/cell, 25°C/77°F)
	6.00 AH/1.20A	(5hr, 1.75V/cell, 25°C/77°F)
	5.37 AH/1.79A	(3hr, 1.75V/cell, 25°C/77°F)
	4.55 AH/4.55A	(1hr, 1.60V/cell, 25°C/77°F)
Max. Discharge Current	105A (5s)	
Internal Resistance	Approx 23mΩ	
Operating Temp.Range	Discharge	: -15 - 50°C (5 - 122°F)
	Charge	: 0 - 40°C (32 - 104°F)
	Storage	: -15 - 40°C (5 - 104°F)
Nominal Operating Temp.Range	25±3°C (77±5°F)	
Cycle Use	Initial Charging Current less than 2.1A. Voltage 14.4V - 14.7V at 25°C (77°F) Temp.Coefficient -30mV/°C	
Standby Use	No limit on Initial Charging Current Voltage 13.5V - 13.8V at 25°C (77°F) Temp.Coefficient -20 mV/°C	
Capacity affected by Temperature	40°C (104°F) 103% 25°C (77°F) 100% 0°C (32°F) 86%	
Self Discharge	Sentry AGM series batteries may be stored for up to 6 months at 25°C (77°F) and then a freshening charge is required. For higher temperatures the time interval will be shorter.	



Applications

- All purpose
- Standby Applications
- Recreation Vehicles
- Uninterruptible Power Supply (UPS)
- Electric Power System (EPS)
- Fire & Security
- Generators
- Medical Equipment

Dimensions

F1 Terminal

Unit: mm (inches)

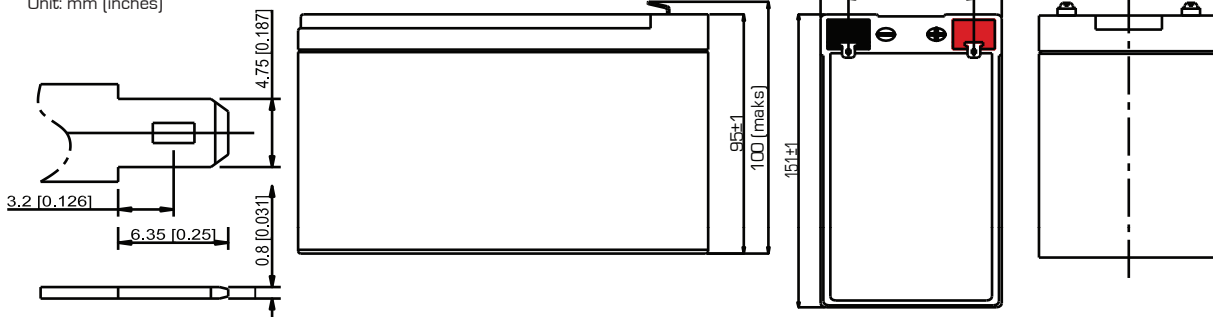

Constant Current Discharge (Amperes) at 25°C (77°F)

F.V./Time	5min	10min	15min	20min	30min	45min	1h	2h	3h	4h	5h	6h	8h	10h	20h
1.85V/cell	18.0	12.8	10.48	8.79	6.53	4.79	3.86	2.29	1.69	1.36	1.14	0.98	0.774	0.640	0.345
1.80V/cell	21.4	14.3	11.4	9.44	6.94	5.05	4.03	2.38	1.74	1.40	1.17	1.01	0.791	0.653	0.350
1.75V/cell	24.2	15.6	12.2	10.0	7.29	5.27	4.18	2.45	1.79	1.43	1.20	1.03	0.805	0.663	0.357
1.70V/cell	26.7	16.7	12.9	10.5	7.59	5.46	4.32	2.51	1.83	1.46	1.22	1.05	0.817	0.672	0.361
1.65V/cell	28.8	17.7	13.5	10.9	7.86	5.62	4.46	2.57	1.86	1.48	1.23	1.06	0.826	0.680	0.365
1.60V/cell	30.6	18.6	14.1	11.3	8.09	5.76	4.55	2.61	1.89	1.50	1.25	1.07	0.834	0.685	0.367

Constant Power Discharge (Watts/Cell) at 25°C (77°F)

F.V./Time	5min	10min	15min	20min	30min	45min	1h	2h	3h	4h	5h	6h	8h	10h	20h
1.85V/cell	34.2	24.5	20.2	17.1	12.8	9.44	7.64	4.56	3.37	2.72	2.29	1.99	1.565	1.296	0.701
1.80V/cell	40.2	27.2	21.9	18.3	13.5	9.91	7.96	4.72	3.47	2.79	2.34	2.03	1.593	1.318	0.708
1.75V/cell	45.1	29.5	23.3	19.3	14.2	10.3	8.23	4.85	3.55	2.85	2.39	2.06	1.616	1.344	0.719
1.70V/cell	49.2	31.3	24.5	20.1	14.7	10.6	8.48	4.96	3.62	2.89	2.42	2.09	1.633	1.347	0.725
1.65V/cell	52.6	32.9	25.5	20.8	15.2	10.9	8.73	5.05	3.68	2.93	2.45	2.11	1.649	1.359	0.731
1.60V/cell	55.5	34.3	26.3	21.5	15.5	11.2	8.88	5.12	3.72	2.96	2.47	2.13	1.660	1.367	0.734

Discharge Characteristics

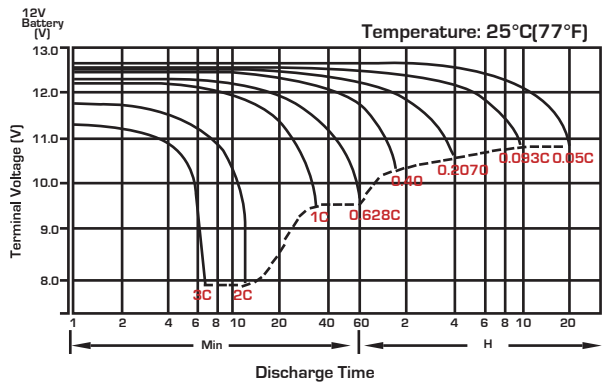

Float Charging Characteristics

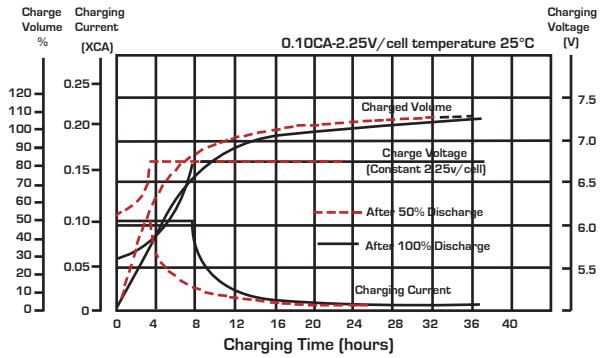

Temperature Effects in Relation to Battery Capacity

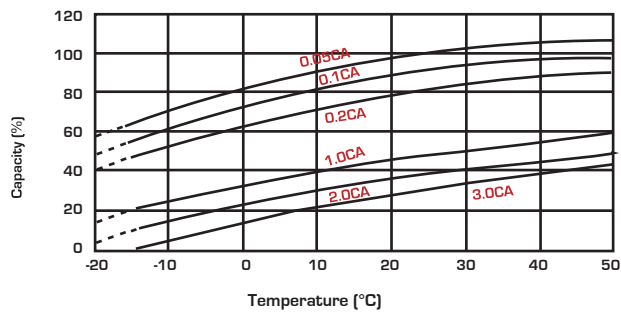

Effect of Temperature on Long Term Float Life

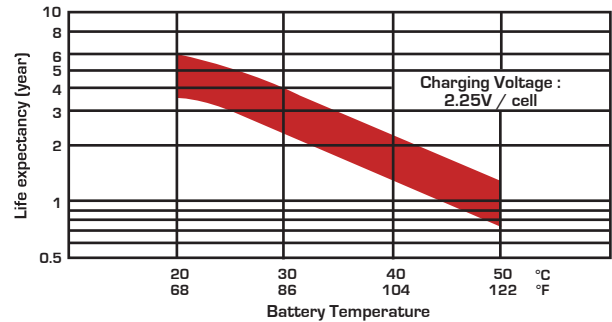

Cycle Life in Relation to Depth of Discharge

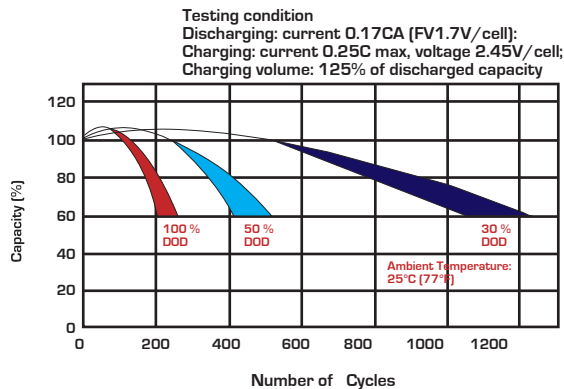

Self Discharge Characteristics

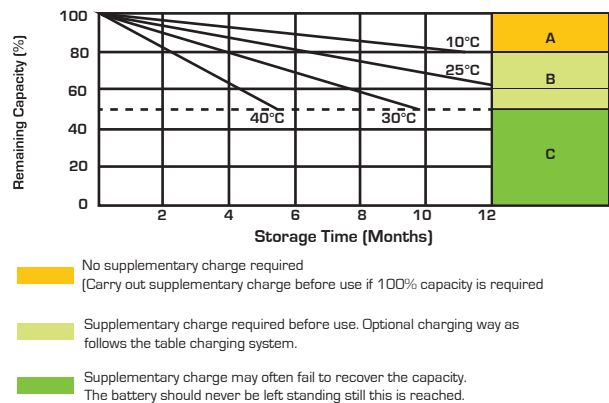

Charging System

DOD	Current Limit (A)	Constant Voltage (V)	Fully Charged Time (h)
20	0.15C ₁₀	13.5-13.8 vpc (12V)	10
	0.20C ₁₀	6.75-6.9 vpc (6V)	8
50	0.15C ₁₀	13.5-13.8 vpc (12V)	15
	0.20C ₁₀	6.75-6.9 vpc (6V)	12
80	0.15C ₁₀	13.5-13.8 vpc (12V)	16
	0.20C ₁₀	6.75-6.9 vpc (6V)	14
100	0.15C ₁₀	13.5-13.8 vpc (12V)	20
	0.20C ₁₀	6.75-6.9 vpc (6V)	18

State of Charge (SOC)

Open Circuit Voltage (V/cell)	Open Circuit Voltage (12V/cell)	Open Circuit Voltage (6V/cell)	State of Charge (% of full charge capacity)
2.14-2.15	12.84-12.90	6.42-6.46	100
2.12-2.13	12.72-12.78	6.36-6.39	90
2.11	12.66	6.33	80
2.09	12.54	6.27	70
2.07	12.42	6.21	60
2.05	12.30	6.15	50



Sealed Performance Batteries

Domestic Sales | Ph: +61 (0)7 3386 1102 | Fax: +61 (0)7 3102 9913

sales@spb.net.au | www.sealedperformance.com.au

National Warehouse | 1 Ant Road | Yatala, Brisbane QLD 4207

Melbourne Office | 2/9 Compark Circuit | Mulgrave, Melbourne VIC 3170

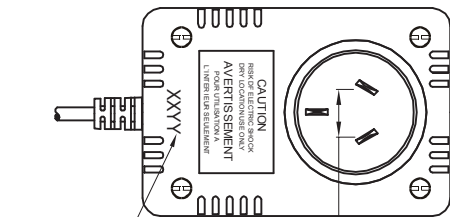
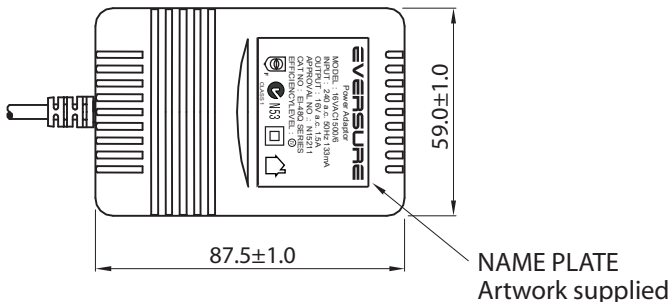
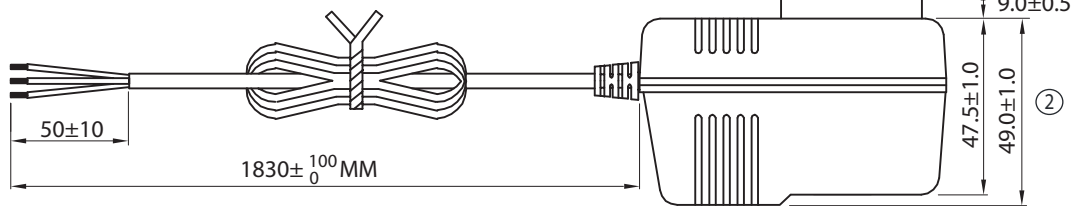
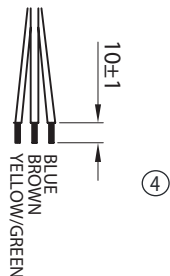

	REVISED	DRAWN	APPROVED
①	AMENDED PACKING QTY AND CARTON SIZE	JACKY 10/08/09	GARY 10/08/09
②	ADDED DATE CODE ON CASE AND DIMENSIONS	JACKY 07/12/09	GARY 07/12/09
③	ADDED PASSED LABEL ON CARTON	TODD 22/12/10	JACKY 22/12/10
④	AMENDED AC PINS DIMENSION & ADDED WIRES COLORS	ANLEI 01/11/12	ANLEI 01/11/12
⑤	CHANGED CROSS-SHAPED SCREW TO SHAPE SCREW ON CASE	MARK 31/08/15	FREDERICK 31/08/15

- NOTES:
1. OUTPUT CORD: 20AWGX3C 1.83M Lead Free GREY (RAL7035)
 2. CASE: GREY (RAL7035)
 3. SECURITY SCREW IS AN ESSENTIAL REQUIREMENT, BOTH "" AND "" SHAPE ARE ACCEPTABLE

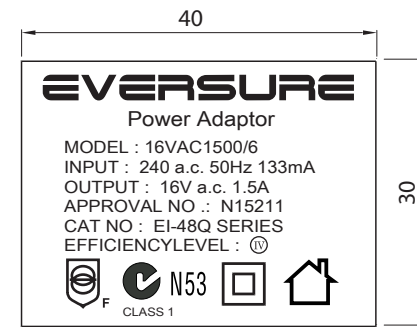

LABEL ARTWORK
Black word on Silver base label

TE DRAWING NO: TE40-0001 R5 PART NO: 16VAC1500MPS/6

DESCRIPTION: AC ADAPTOR EI-48Q, 16VAC1500mA, 3 WIRE - MEPS

SIZE	A4	DATE	30/04/09	CHECKED	KEVIN 30/04/09	ORDER REF:	0420	SHEET 1 OF 3	TOLERANCES UNLESS OTHERWISE STATED X.= +/- .X.= +/-0.5 .XX.= +/-0.2
UNIT	MM	DRAWN	KEVIN	APPROVED	FRANK 30/04/09	CUSTOMER:	TE		
SCALE	NTS	MANU:		DATE:					



THIS DRAWING AND SPECIFICATIONS ARE THE PROPERTY OF TELEPHONE EQUIPMENT (NSW) Pty Ltd AND SHALL NOT BE REPRODUCED OR USED IN ANY MANNER WITHOUT THE PRIOR WRITTEN CONSENT OF TELEPHONE EQUIPMENT (NSW) Pty Ltd

ITEM	SPECIFICATION	
1. Primary rated input voltage	AC240V 50Hz 133mA	
2. Secondary rated output voltage and current	Unloaded voltage: AC 18 V ± 5% Loaded Voltage : AC 16 V ± 5% AT 1500 mA	
3. Ripple voltage	*** mV (RMS) MAX. AT Rated Loading	
4. Insulation resistance	Primary - secondary: DC 500 V 100 MΩ Min	
5. Dielectric withstand test	Primary - secondary: AC 3.64 KV 1 seconds	
6. Temperature rise	At rated loading 90°C max. For input coil (By resistance method) and 55°C max. on case surface (By use of thermometer)	
7. EFFICIENCY	≥ 79%	
8. Leadout	Primary	SAA PLUG IN TYPE
	Secondary	PVC cable length: 1.8 Meter Colour : GREY (RAL7035) Wire size: AWG#20/3C Plug : STRIPPED AND TINNED
9. Test circuit		
10. Case	SAA48 colour = GREY (RAL7035)	

	REVISED	DRAWN	APPROVED
①	AMENDED PACKING QTY AND CARTON SIZE	JACKY 10/08/09	GARY 10/08/09
②	ADDED DATE CODE ON CASE AND DIMENSIONS	JACKY 07/12/09	GARY 07/12/09
③	ADDED PASSED LABEL ON CARTON	TODD 22/12/10	JACKY 22/12/10
④	AMENDED AC PINS DIMENSION & ADDED WIRES COLORS	ANLEI 01/11/12	ANLEI 01/11/12
⑤	CHANGED CROSS-SHAPED SCREW TO SHAPE SCREW ON CASE	MARK 31/08/15	FREDERICK 31/08/15

TE DRAWING NO: TE40-0001 R5

PART NO: 16VAC1500MPS/6

DESCRIPTION: AC ADAPTOR EI-48Q, 16VAC1500mA, 3 WIRE - MEPS



THIS DRAWING AND SPECIFICATIONS ARE THE PROPERTY OF TELEPHONE EQUIPMENT (NSW) Pty Ltd AND SHALL NOT BE REPRODUCED OR USED IN ANY MANNER WITHOUT THE PRIOR WRITTEN CONSENT OF TELEPHONE EQUIPMENT (NSW) Pty Ltd

SIZE	A4	DATE	30/04/09	CHECKED	KEVIN 30/04/09		ORDER REF:	0420	SHEET 2 OF 3	TOLERANCES UNLESS OTHERWISE STATED X.= +/- .X= +/-0.5 .XX= +/-0.2
UNIT	MM	DRAWN	KEVIN	APPROVED	FRANK 30/04/09		CUSTOMER:	TE		
SCALE	NTS	MANU:				DATE:				

	REVISED	DRAWN	APPROVED
①	AMENDED PACKING QTY AND CARTON SIZE	JACKY 10/08/09	GARY 10/08/09
②	ADDED DATE CODE ON CASE AND DIMENSIONS	JACKY 07/12/09	GARY 07/12/09
③	ADDED PASSED LABEL ON CARTON	TODD 22/12/10	JACKY 22/12/10
④	AMENDED AC PINS DIMENSION & ADDED WIRES COLORS	ANLEI 01/11/12	ANLEI 01/11/12
⑤	CHANGED CROSS-SHAPPED SCREW TO SHAPE \perp . SCREW ON CASE	MARK 31/08/15	FREDERICK 31/08/15

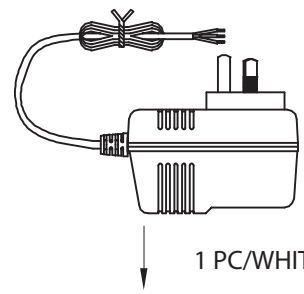

1 PC/WHITE BOX

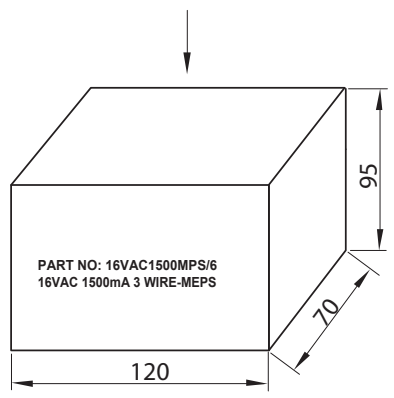
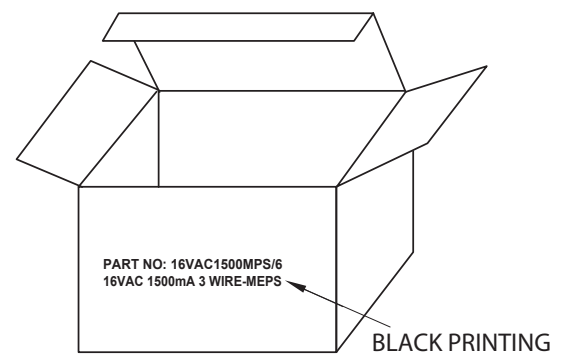

20 BOXES/CARTON ①

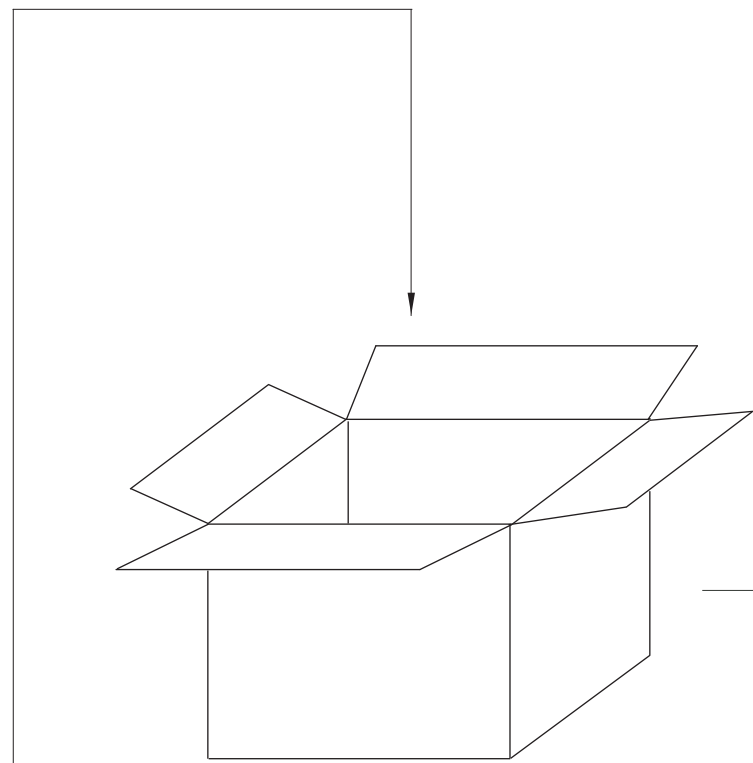

ADHESIVE TAPE

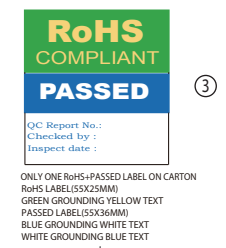
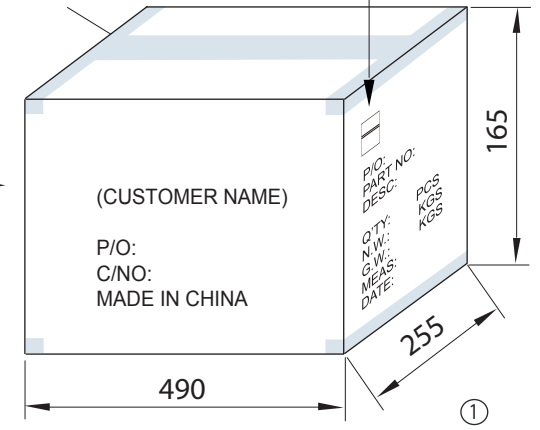

TE DRAWING NO: TE40-0001 R5 PART NO: 16VAC1500MPS/6

DESCRIPTION: AC ADAPTOR EI-48Q,16VAC1500mA, 3 WIRE - MEPS



THIS DRAWING AND SPECIFICATIONS ARE THE PROPERTY OF TELEPHONE EQUIPMENT (NSW) Pty Ltd AND SHALL NOT BE REPRODUCED OR USED IN ANY MANNER WITHOUT THE PRIOR WRITTEN CONSENT OF TELEPHONE EQUIPMENT (NSW) Pty Ltd

SIZE	A4	DATE	30/04/09	CHECKED	KEVIN 30/04/09		ORDER REF:	0420	SHEET 3 OF 3	TOLERANCES UNLESS OTHERWISE STATED X.= +/-1 .X.= +/-0.5 .XX.= +/-0.2
UNIT	MM	DRAWN	KEVIN	APPROVED	FRANK 30/04/09		CUSTOMER:	TE		
SCALE	NTS	MANU:					DATE:			



Specifications TELLC0280

The TELLC0280 is the telephone lead with 606 Socket and 2 Meter length of Telephone Cord.

Colour: Ivory.

