

Spectra SP Series

4 to 32-Zone Expandable Security Systems

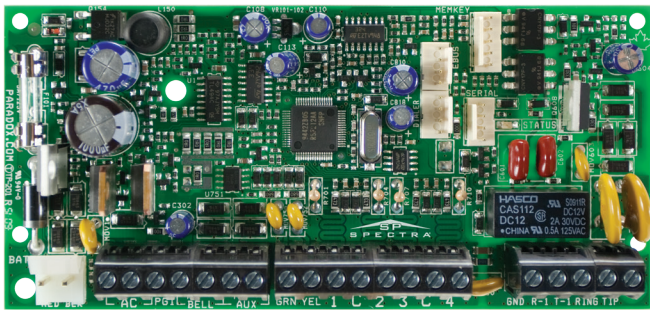

Description

Spectra SP control panels (SP4000, SP5500, SP6000, SP65, and SP7000) offer a combination of innovative features and an advanced communication bus for a uniquely expandable security system. Through its communication bus, all Spectra SP panels can be expanded via wireless and hardwired expansion modules and a variety of accessory modules. With their in-field firmware upgrade capability, the Spectra SP series allows installers to upgrade their system without hassle – quickly, easily, and on-site. To further facilitate installation, every Spectra SP panel can be configured using easy-to-follow, menu-driven programming.

Spectra SP also features multipath communication; this enables your system to communicate through multiple channels, including telephony with its built-in landline dialer, IP with the IP150 Internet Module, IP/GPRS/GSM with the PCS series module, and voice with the VDMP3 Plug-In Voice Module.

With its reliable communication technology, flexible expansion and user-friendly keypads, Spectra SP is the complete residential or commercial security solution.

Features

- Supports StayD mode
- 4-wire expansion bus
- Wireless expansion (via RTX3 / RX1)
- Expandable to 32 zones
- Expandable to 16 PGMs
- 2 partitions
- 32 user codes
- Supports PCS series modules
- Supports IP150 Internet Module
- Supports VDMP3 Plug-in Voice Module
- Supports REM3 Hand-held Remote Keypad
- Supports SR150 Wireless Siren
- Landline dialer (except SP65)
- In-field firmware upgradable

System Overview



For compatibility details, visit us at paradox.com

Feature Details



Internet Communication (IP150)

The IP150 Internet Module allows you to control and monitor your security system remotely through any web browser. It allows for email notifications of important system events such as alarms, arm/disarm events, and troubles. For example, receive an email at work when your kids get back from school. Also, view the live status of your system and arm/disarm it. For instance, you have just left your office for the weekend but are unsure whether you armed the system. Simply check the status of your system from a laptop and arm it.



Wireless Communication (PCS Series)

The PCS series modules provide the Spectra SP control panels with wireless communication capabilities to report system events via IP, GPRS, and/or GSM. Whether it be uploading/downloading via IP or GPRS, receiving system status and events by voice or text message, or reporting to the monitoring station via IP, GPRS, or GSM, the PCS series enhances the communication capabilities of any Spectra SP installation.



Voice Communication (VDMP3)

The VDMP3 is a plug-in, voice-assisted module that can be programmed to call up to five telephone numbers in the event of an alarm. For example, when an alarm occurs at your store during off-hours, every employee can receive notification via telephone. You can also call the VDMP3 from an outside line, enabling you to arm or disarm the system as well as activate PGMs. The VDMP3 essentially turns any outside telephone into a keypad. The VDMP3 is easy to install; plug it in directly onto the panel, set the phone numbers, and select the activation event.



StayD

StayD resolves all issues with common security systems and represents the only solution for secure living. The revolutionary StayD feature represents a completely reversed philosophy compared to all other security systems made today. Traditional systems share the same principle - in order to provide security, users must remember to arm the system; otherwise the system is disarmed and does not provide security. A StayD system is always armed, and needs only to be partly disarmed when an entry or exit is needed. With StayD, you can truly have peace of mind knowing, that you are always protected.



In-field Upgradable

Spectra SP is not only easy to install, but is also fully in-field upgradable, allowing for simple on-site updates. The process is effortless; connect the PC to the panel and you are a few clicks away from performing a complete system upgrade within minutes. No need to change panels or hardware; all the updates are performed using Paradox's InField Firmware Upgrade Software.



App-based System Control

The Insite GOLD app enables you to remotely access your Paradox security system and view your system cameras. Insite GOLD provides lots of functionality and information at one's fingertip. It has an intuitive user-interface which enables you to easily connect to your security system and edit settings. Now you can control your Paradox security system from any Android / iOS smartphone.

TM70 Overview



TM70: Intuitive Touchscreen

- ## SpotOn Locator™

Upload photos, images, or schematics to eliminate the need for deciphering LED zone lights. These images display any door, window, or motion detector that are active. Since the images are uploaded by the user, they are truly customized, and can be unique to each installation. SpotOn Locator™ is integrated in the original firmware, and when purchased, is unlocked with an authorization code.

- ## OneScreen Monitoring™

Provides a real-time visual display of the system's status on one screen. It allows the user to choose which partitions will be displayed showing arming level, alarm, ready, and troubles. It also displays zone statuses; open, close, bypass, alarm, and tamper. OneScreen Monitoring™ also features Solo Test™ mode, which allows installers and users to easily test all system zone's via the TM70 Touch's screen. OneScreen Monitoring™ is integrated in the original firmware, and when purchased, is unlocked with an authorization code.

Specifications

Display	16-bit, color LCD; 8.6 x 15.4 cm (3.1 x 5.9 in.), 800 x 480 pixels
Input Voltage	9 to 15 Vdc
Current Consumption	250 mA at max brightness + 80 mA sounder
Keypad Zone Input	1 for a detector or external temperature sensor
Tamper	Built-in, cover and wall
Humidity	5 to 90%
Operating Temperature	-10 to 55 °C (14 to 131 °F)
Compatibility	Swan, EVO, Spectra, Magellan

Note: All control panel outputs are rated to operate between 11.4 Vdc and 12.5 Vdc.



Specifications PRX278000033-P2C

The PRX278000033-P2C is a metal box enclosure for provision multiple module and panel mounting.

Features:

- Many punch-out holes for simple wiring
- Easy door removal
- Sizes: 28cm X 28cm X 7.6cm (11" x11" x 3")

P ▲ R ▲ D O X™



Specifications PRXK-TK278

The PRXK-TK278 is a BOM Kit for 1x tamper switch PRX2502302000-P2C and 1x tamper bracket PRX2781030000-P2C to suit with Paradox Metal Box Enclosure PRX2780000033-P2C; to protect against tampering (opening door or removal from wall).

P ▲ R ▲ D O X™

SP5500+ / SP6000+ / SP7000+ User Guide

4 to 32-Zone Expandable Security Systems



P ▲ R ▲ D O X™

AVERTISSEMENT : Un mauvais ajustement de la hauteur pourrait compromettre l'efficacité du détecteur.

Essai de marche

À 20 °C (68 °F), en mode de protection normale et en mode de traitement simple, un humain ne devrait pas pouvoir traverser plus d'une zone complète (composé de 2 faisceaux, détecteurs gauche et droit du capteur) dans la zone de couverture, et ce peu importe le mouvement effectué : marche lente, rapide ou course. En mode de protection élevée, la quantité de mouvement nécessaire à la génération d'une alarme est doublée. La largeur approximative d'un faisceau maximal à 11 m (35 pi) du détecteur est de 1,8 m (6 pi). Lors de l'essai de marche, s'assurer de toujours marcher d'un côté à l'autre de la trajectoire de détection, et non en direction du détecteur.

Diagramme de faisceau

Le DG75+ offre une portée de détection de 11 m x 11 m (35 pi x 35 pi) avec angle de prise de vue de 90°. Pour aider à la sélection du lieu d'installation et à l'exécution des essais de marche, voir la Figure 2 au verso.

Figure/Figura 1 Overview / Vista General / Vue d'ensemble

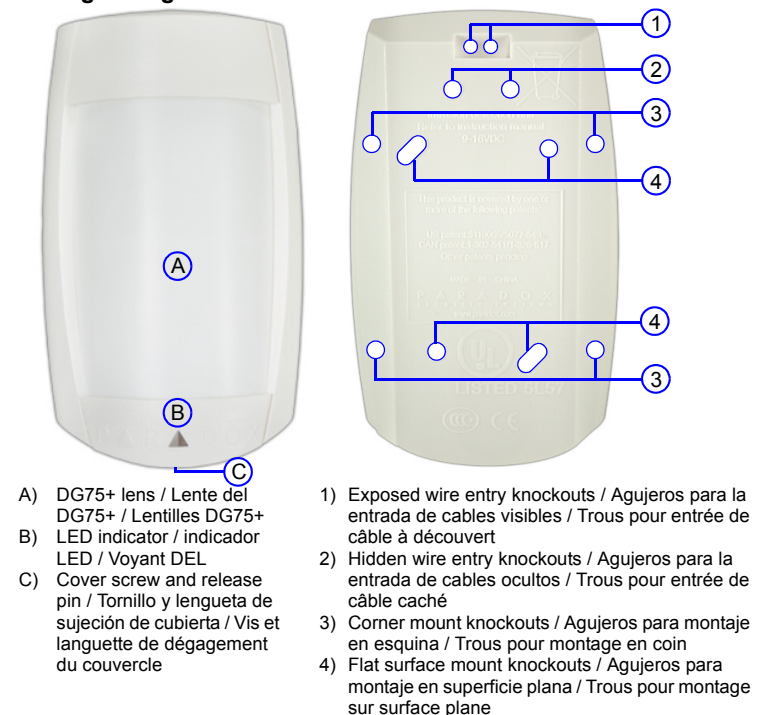

Figure/Figura 2 DG75+ Pet Array Beam Pattern / Estructura de Hacces / Diagramme de faisceau

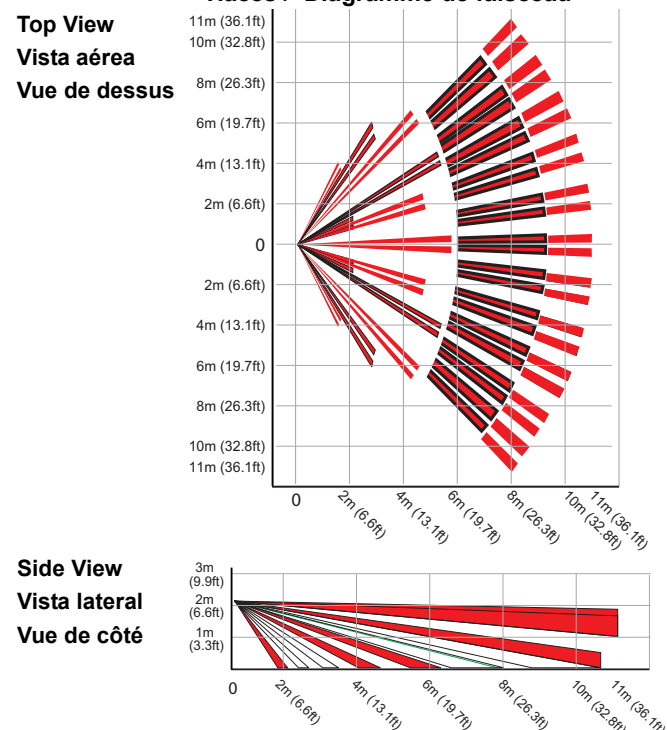

Figure/Figura 3 Wiring / Cableado / Câblage

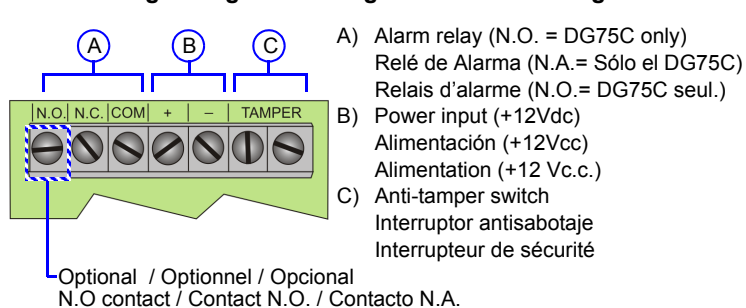

Figure/Figura 4 PCB Overview / Vista General / Vue d'ensemble

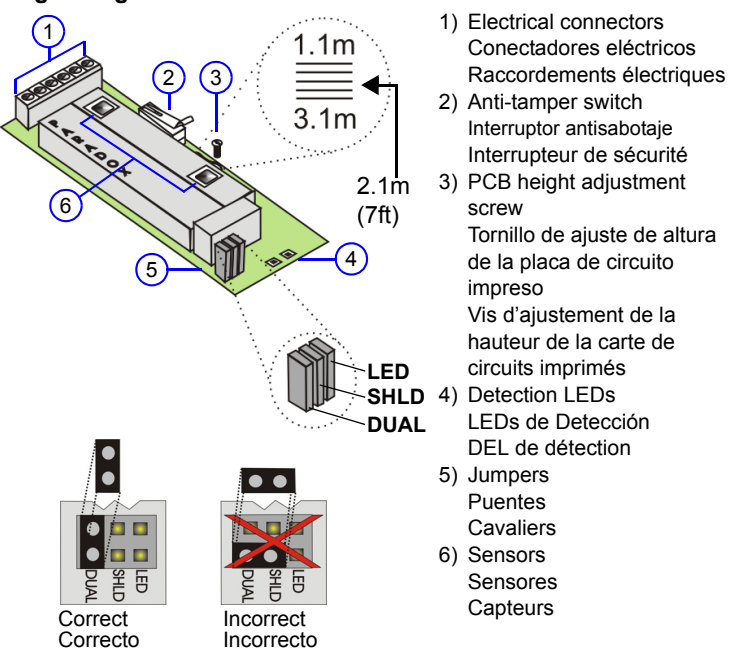

Table/Tableau/Tabla 1

Jumper Settings / Ajuste de los Puentes / Réglages des cavaliers

LED	LED Indicator(s) Indicadores LED Voyant(s) DEL(s)
	OFF = Disabled / Deshabilitado / Désactivé ON = Enabled / Habilitado / Activé Δ
SHLD	Digital Shield (Sensitivity) Blindaje Shield Digital (Sensibilidad) Algorithme numérique Shield (Sensibilité)
	OFF = High Shield / Blindaje Superior / Protection élevée ON = Normal Shield / Blindaje Normal / Protection normale Δ
DUAL	Processing Type Tipo de Procesamiento Type de traitement
	OFF = Dual Edge / Polaridad Doble / Divisé ON = Single Edge / Polaridad Simple / Simple Δ

Δ=default, de fábrica, par défaut

Figure/Figura 5 PCB Height / Altura de la PCI / Hauteur du PCB

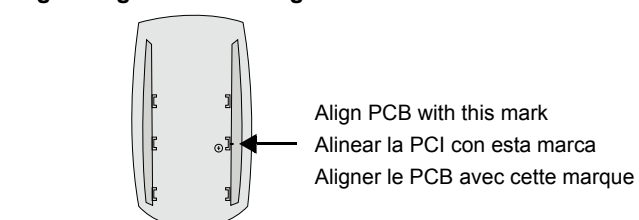

LED Feedback / LED de Confirmación / Rétroaction DEL

Legend / Legend / Légende	
R = Red / Rojo / Rouge G = Green / Verde / Verte	
△ = Off / Désact. ▲ = On / Act. ⚡ = Flashing / Parpadeo / Clignote	
LED State	Condition
▲ R	On 3 seconds = Alarm signal generated Encendido 3 segundos = Se generó señal de alarma Allumée 3 secondes = Signal d'alarme généré
⚡ R	Flash = Movement signal does not reach required energy for an alarm Parpadeo = Señal de movimiento no alcanza la energía necesaria para generar una alarma Clignote = Signal de mouvement n'atteint pas l'énergie requise pour une alarme
▲ R	Flash 5 seconds = Power-up self-test Parpadeo 5 segundos = Prueba automática en encendido Clignote 5 secondes = Test automatique de mise sous tension
⚡ R	Flash = Signal does not match the characteristics of an alarm (non-movement signal) Parpadeo = La señal no reúne las características de una alarma (señal de sin movimiento) Clignote = Signal ne correspond pas aux caractéristiques d'une alarme (signal de non-mouvement)
▲ G	

Specifications

Pet immunity	Up to 40kg (90lbs)
Sensor type	Dual Element Infrared x 2
Coverage -90° (standard)	11m (35ft) X 11m (35ft)
Installation Height	2.1m to 2.7m (7ft to 9ft)
RFI / EMI rejection	10V/m rejection from 10MHz to 1GHz
Sensor geometry	Rectangular
Voltage input	Typically 11 to 16Vdc
Current consumption	15mA max. / 6mA min. (LED disabled)
Anti-tamper switch	150mA / 28Vdc, N.C.
Lens	2nd generation Fresnel lens, LODIFF®, segments
Alarm output*	DG75+ = Form A relay 100mA/28Vdc, N.C. DG75C = Form C relay 200mA/ 28Vdc, N.C./N.O.
Detection speed	0.2m/s to 3.5m/s (0.6ft/s to 11.5ft/s) Ingress
Operating temperature	-10°C to +50°C (14°F to +122°F)
Environmental Standards	Complies with EN 50131 Security Grade 2 / Environmental Class I

* Form C relay has not been investigated for compliance to EN 50131.

Patents: One or more of the following US patents may apply: 7046142, 6215399, 6111256, 6104319, 5920259, 5886632, 5721542, 5287111, and RE39406 and other pending patents may apply. Canadian and international patents may also apply. LODIFF® lens: patent #4,787,722 (U.S.). Canadian and international patents may also apply. LODIFF® a registered trademark of Fresnel Technologies Inc.

Trademarks: Digigard and Shield are trademarks or registered trademarks of Paradox Ltd. or its affiliates in Canada, the United States and/or other countries.
Certification: For the latest information on products approvals, such as UL and CE, please visit www.paradox.com.

Warranty: For complete warranty information on this product please refer to the Limited Warranty Statement found on the website www.paradox.com/terms. Your use of the Paradox product signifies your acceptance of all warranty terms and conditions.

© 2015 Paradox Ltd. All rights reserved. Specifications may change without prior notice.

Especificaciones

Inmune a mascotas	De hasta 40kg (90lbs)
Tipo de Sensor	Infrarrojo de Dos Elemento (x 2)
Cobertura -90° (estándar)	11m (35ft) X 11m (35ft)
Altura de Instalación	2.1m a 2.7m (7ft a 9ft)
Rechazo a interferencias electromagnéticas y de radiofrecuencia	10V/m de rechazo entre 10MHz a 1GHz
Geometría del Sensor	Rectangular
Tensión de entrada	Típico de 11 a 16Vcc
Consumo de corriente	15mA máx. / 6mA mín. (LED deshabilitado)
Interruptor antisabotaje	150mA/28Vcc, N.C.

Lente	Lente Fresnel de 2da generación, LODIFF®, segmentos
Salida de alarma*	DG75+ = Relé de Forma A de 100mA/28Vcc, N.C. DG75C = Relé de Forma C de 200mA/28Vcc, N.C./N.A.
Velocidad de detección	Ingreso 0.2m/s a 3.5m/s (0.6ft/s a 11.5ft/s)
Temperatura de funcionamiento	-10°C a +50°C (14°F a +122°F)
Estándares Ambientales	Cumple con EN 50131 Security Grade 2 / Environmental Class I

* El relé de Forma C no ha sido examinado respecto a su conformidad con EN 50131.

Patentes: Una o más de las siguientes patentes EE.UU. podría aplicarse: 7046142, 6215399, 6111256, 6104319, 5920259, 5886632, 5721542, 5287111, y RE39406 y otras patentes pendientes podrían aplicarse. Patentes canadienses e internacionales también podrían aplicarse. Lente LODIFF®: patente #4,787,722 (EE.UU.). Patentes canadienses e internacionales también podrían aplicarse. LODIFF® es una marca registrada de Fresnel Technologies Inc.

Marcas de comercio: Digigard y Shield son marcas de comercio o marcas registradas de Paradox Ltd. o de sus afiliados en Canadá, Estados Unidos y/o otros países.

Certificación: Para información actualizada respecto a la homologación de productos, como UL y CE, sírvase visitar nuestro sitio Web en www.paradox.com.

Garantía: Para una información detallada acerca de la garantía de este producto consultar la Declaración de Garantía Limitada (en inglés) que se encuentra en el sitio web de paradox: www.paradox.com/terms. El uso de este producto Paradox significa la aceptación de todos los términos y condiciones de la garantía.

© 2015 Paradox Ltd. Todos los derechos reservados. Las especificaciones pueden cambiar sin previo aviso.

Spécifications

Insensibilité aux animaux	Jusqu'à 40 kg (90 lb)
Type de capteur	Élément double infrarouge x 2
Couverture -90° (standard)	11 m (35 pi) X 11 m (35 pi)
Hauteur d'installation	2,1 m à 2,7 m (7 pi à 9 pi)
Protection contre les perturbations électromagnétiques et les interférences radiofréquences	Réjection de 10 V/m entre 10 MHz et 1GHz
Géométrie du capteur	Rectangulaire
Tension d'entrée	Généralement 11 à 16 Vc.c.
Consommation de courant	15 mA max. / 6 mA min. (DEL désact.)
Interrupteur de sécurité	150 mA / 28 Vc.c., N.F.
Lentilles	Lentilles Fresnel 2ème génération, segments LODIFF®
Sortie d'alarme*	DG75+ = Relais de forme A de 100 mA / 28 Vc.c., N.F. DG75C = Relais de forme C de 200 mA / 28 Vc.c., N.F./N.O.
Vitesse de détection	Ingress 0,2 m/s à 3,5 m/s (0,6 pi/s à 11,5 pi/s)
Température de fonctionnement	-10°C à +50°C (14°F à +122°F)
Standards environnementaux	Conforme EN 50131 Security Grade 2 / Environmental Class I

* Le relais de forme C n'a pas encore été examiné pour la conformité avec EN 50131.

Brevets: Un ou plusieurs des brevets suivants peuvent s'appliquer : 7046142, 6215399, 6111256, 6104319, 5920259, 5886632, 5721542, 5287111, et RE39406 et d'autres brevets en instance. Des brevets canadiens et internationaux peuvent aussi s'appliquer. Lentilles LODIFF® : brevet #4,787,722 (U.S.). LODIFF® est une marque déposée de Fresnel Technologies Inc.

Marques de commerce: Digigard et Shield sont des marques de commerce ou des marques de commerce déposées de Paradox Ltée ou de ses sociétés affiliées au Canada, aux États-Unis et/ou dans d'autres pays.

Certification: Pour les renseignements les plus récents concernant l'approbation UL et CE des produits, veuillez visiter le www.paradox.com.

Garantie: Pour tous les renseignements sur la garantie de ce produit, veuillez vous référer à la Déclaration de garantie limitée qui se trouve sur le site Web au www.paradox.com/terms. L'utilisation des produits Paradox signifie l'acceptation de toutes les modalités et conditions de la garantie.

© Paradox Ltée, 2015. Tous droits réservés. Spécifications sujettes à changement sans préavis.



Specifications DFMSC03/CO/TOP

The DFMSC03/CO/TOP is the siren cover kit.

This siren cover kit comes with:

- UV treated plastic cover
- Combo Siren/Horn, 8 Ω /15W
- LED Strobe (Water-proof), 50mA
- Reed tamper switch
- Top hat piezo, 90mA @ 105dB
- 7-Way terminal block (pre-wired)

Total current draw for DFMSC03/CO/TOP is 590mA.

Operating voltage is 12VDC.

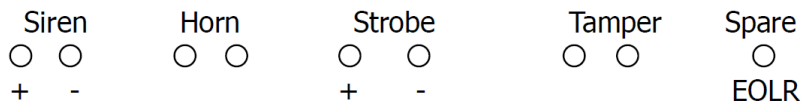



VRLA 12V7AH

SA12V7

Specifications

Nominal Voltage	12 V	
Nominal Capacity 20HR	7.0 AH	
Dimensions	Length	151±1mm (5.94 inches)
	Width	65±1mm (2.56 inches)
	Container Height	95±1mm (3.74 inches)
	Total Height (with terminal)	100±1mm (3.94 inches)
Approx Weight	Approx 2.10 kg (4.63 lbs)	
Terminal	F1	
Container Material	ABS Plastic	
Lead Material	Purity Lead 99.995%	
Sulfuric Acid	Distilled Sulfuric Acid (Zero metal content)	
Separator	AGM	
Rated Capacity	7.00 AH/0.350A	(20hr, 1.80V/cell, 25°C/77°F)
	6.53 AH/0.653A	(10hr, 1.80V/cell, 25°C/77°F)
	6.00 AH/1.20A	(5hr, 1.75V/cell, 25°C/77°F)
	5.37 AH/1.79A	(3hr, 1.75V/cell, 25°C/77°F)
	4.55 AH/4.55A	(1hr, 1.60V/cell, 25°C/77°F)
Max. Discharge Current	105A (5s)	
Internal Resistance	Approx 23mΩ	
Operating Temp.Range	Discharge	: -15 - 50°C (5 - 122°F)
	Charge	: 0 - 40°C (32 - 104°F)
	Storage	: -15 - 40°C (5 - 104°F)
Nominal Operating Temp.Range	25±3°C (77±5°F)	
Cycle Use	Initial Charging Current less than 2.1A. Voltage 14.4V - 14.7V at 25°C (77°F) Temp.Coefficient -30mV/°C	
Standby Use	No limit on Initial Charging Current Voltage 13.5V - 13.8V at 25°C (77°F) Temp.Coefficient -20 mV/°C	
Capacity affected by Temperature	40°C (104°F) 103% 25°C (77°F) 100% 0°C (32°F) 86%	
Self Discharge	Sentry AGM series batteries may be stored for up to 6 months at 25°C (77°F) and then a freshening charge is required. For higher temperatures the time interval will be shorter.	



Applications

- All purpose
- Standby Applications
- Recreation Vehicles
- Uninterruptible Power Supply (UPS)
- Electric Power System (EPS)
- Fire & Security
- Generators
- Medical Equipment

Dimensions

F1 Terminal

Unit: mm (inches)

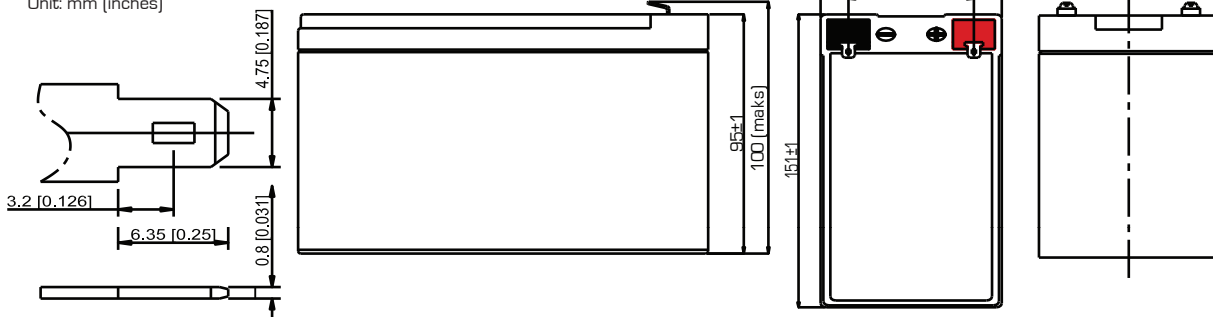

Constant Current Discharge (Amperes) at 25°C (77°F)

F.V./Time	5min	10min	15min	20min	30min	45min	1h	2h	3h	4h	5h	6h	8h	10h	20h
1.85V/cell	18.0	12.8	10.48	8.79	6.53	4.79	3.86	2.29	1.69	1.36	1.14	0.98	0.774	0.640	0.345
1.80V/cell	21.4	14.3	11.4	9.44	6.94	5.05	4.03	2.38	1.74	1.40	1.17	1.01	0.791	0.653	0.350
1.75V/cell	24.2	15.6	12.2	10.0	7.29	5.27	4.18	2.45	1.79	1.43	1.20	1.03	0.805	0.663	0.357
1.70V/cell	26.7	16.7	12.9	10.5	7.59	5.46	4.32	2.51	1.83	1.46	1.22	1.05	0.817	0.672	0.361
1.65V/cell	28.8	17.7	13.5	10.9	7.86	5.62	4.46	2.57	1.86	1.48	1.23	1.06	0.826	0.680	0.365
1.60V/cell	30.6	18.6	14.1	11.3	8.09	5.76	4.55	2.61	1.89	1.50	1.25	1.07	0.834	0.685	0.367

Constant Power Discharge (Watts/Cell) at 25°C (77°F)

F.V./Time	5min	10min	15min	20min	30min	45min	1h	2h	3h	4h	5h	6h	8h	10h	20h
1.85V/cell	34.2	24.5	20.2	17.1	12.8	9.44	7.64	4.56	3.37	2.72	2.29	1.99	1.565	1.296	0.701
1.80V/cell	40.2	27.2	21.9	18.3	13.5	9.91	7.96	4.72	3.47	2.79	2.34	2.03	1.593	1.318	0.708
1.75V/cell	45.1	29.5	23.3	19.3	14.2	10.3	8.23	4.85	3.55	2.85	2.39	2.06	1.616	1.344	0.719
1.70V/cell	49.2	31.3	24.5	20.1	14.7	10.6	8.48	4.96	3.62	2.89	2.42	2.09	1.633	1.347	0.725
1.65V/cell	52.6	32.9	25.5	20.8	15.2	10.9	8.73	5.05	3.68	2.93	2.45	2.11	1.649	1.359	0.731
1.60V/cell	55.5	34.3	26.3	21.5	15.5	11.2	8.88	5.12	3.72	2.96	2.47	2.13	1.660	1.367	0.734

Discharge Characteristics

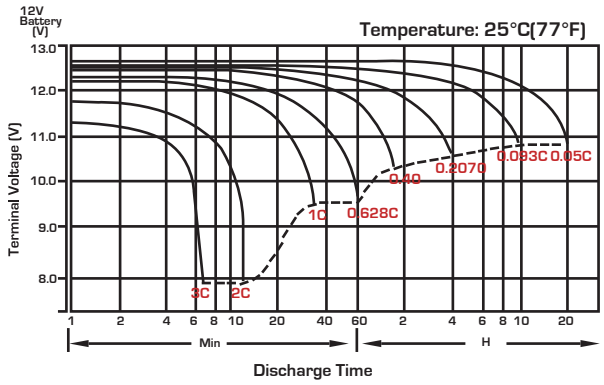

Float Charging Characteristics

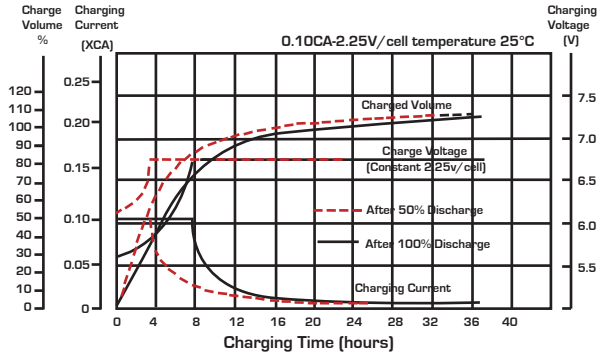

Temperature Effects in Relation to Battery Capacity

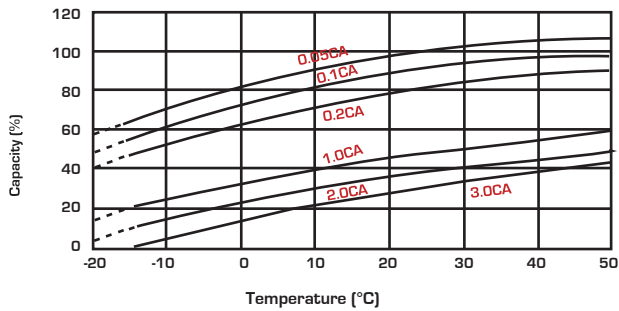

Effect of Temperature on Long Term Float Life

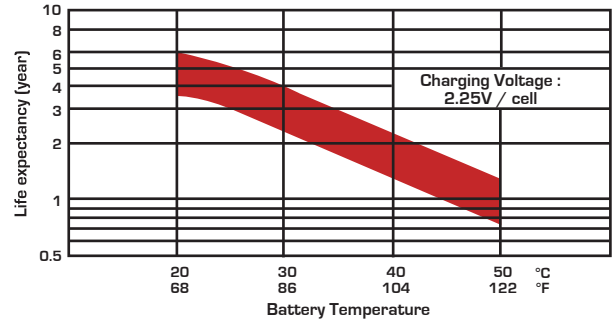

Cycle Life in Relation to Depth of Discharge

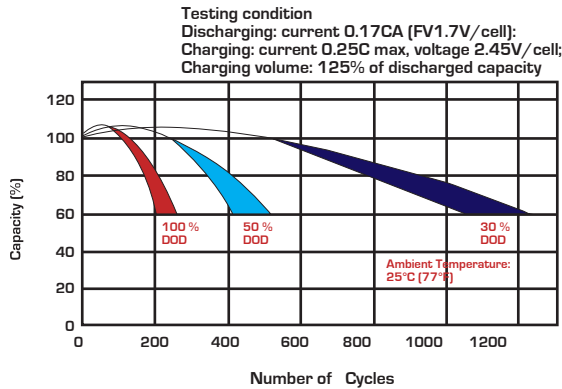

Self Discharge Characteristics

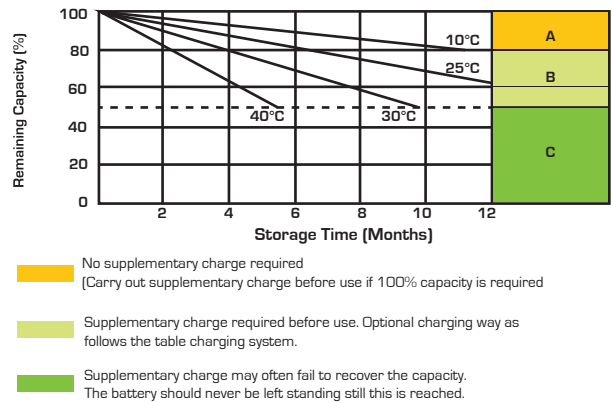

Charging System

DOD	Current Limit (A)	Constant Voltage (V)	Fully Charged Time (h)
20	0.15C ₁₀	13.5-13.8 vpc (12V)	10
	0.20C ₁₀	6.75-6.9 vpc (6V)	8
50	0.15C ₁₀	13.5-13.8 vpc (12V)	15
	0.20C ₁₀	6.75-6.9 vpc (6V)	12
80	0.15C ₁₀	13.5-13.8 vpc (12V)	16
	0.20C ₁₀	6.75-6.9 vpc (6V)	14
100	0.15C ₁₀	13.5-13.8 vpc (12V)	20
	0.20C ₁₀	6.75-6.9 vpc (6V)	18

State of Charge (SOC)

Open Circuit Voltage (V/cell)	Open Circuit Voltage (12V/cell)	Open Circuit Voltage (6V/cell)	State of Charge (% of full charge capacity)
2.14-2.15	12.84-12.90	6.42-6.46	100
2.12-2.13	12.72-12.78	6.36-6.39	90
2.11	12.66	6.33	80
2.09	12.54	6.27	70
2.07	12.42	6.21	60
2.05	12.30	6.15	50



Sealed Performance Batteries

Domestic Sales | Ph: +61 (0)7 3386 1102 | Fax: +61 (0)7 3102 9913
 sales@spb.net.au | www.sealedperformance.com.au
 National Warehouse | 1 Ant Road | Yatala, Brisbane QLD 4207
 Melbourne Office | 2/9 Compark Circuit | Mulgrave, Melbourne VIC 3170

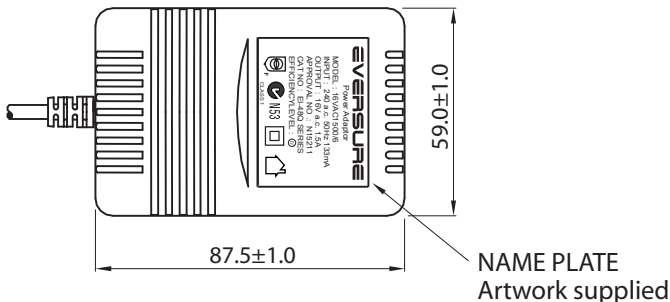
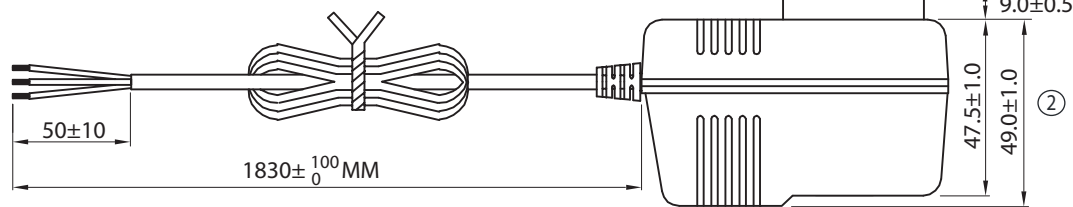
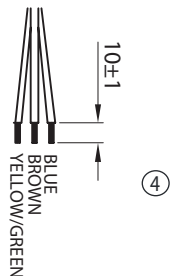

	REVISED	DRAWN	APPROVED
①	AMENDED PACKING QTY AND CARTON SIZE	JACKY 10/08/09	GARY 10/08/09
②	ADDED DATE CODE ON CASE AND DIMENSIONS	JACKY 07/12/09	GARY 07/12/09
③	ADDED PASSED LABEL ON CARTON	TODD 22/12/10	JACKY 22/12/10
④	AMENDED AC PINS DIMENSION & ADDED WIRES COLORS	ANLEI 01/11/12	ANLEI 01/11/12
⑤	CHANGED CROSS-SHAPED SCREW TO SHAPE SCREW ON CASE	MARK 31/08/15	FREDERICK 31/08/15

- NOTES:
1. OUTPUT CORD: 20AWGX3C 1.83M Lead Free GREY (RAL7035)
 2. CASE: GREY (RAL7035)
 3. SECURITY SCREW IS AN ESSENTIAL REQUIREMENT, BOTH "" AND "" SHAPE ARE ACCEPTABLE

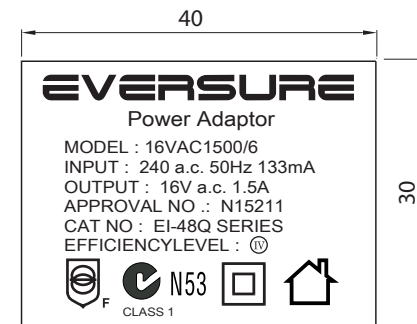

LABEL ARTWORK
Black word on Silver base label

TE DRAWING NO: TE40-0001 R5					PART NO: 16VAC1500MPS/6					
DESCRIPTION: AC ADAPTOR EI-48Q, 16VAC1500mA, 3 WIRE - MEPS										
SIZE	A4	DATE	30/04/09	CHECKED	KEVIN 30/04/09		ORDER REF:	0420	SHEET 1 OF 3	TOLERANCES UNLESS OTHERWISE STATED X.= +/- .X.= +/-0.5 .XX.= +/-0.2
UNIT	MM	DRAWN	KEVIN	APPROVED	FRANK 30/04/09		CUSTOMER: TE			
SCALE	NTS	MANU:				DATE:				



THIS DRAWING AND SPECIFICATIONS ARE THE PROPERTY OF TELEPHONE EQUIPMENT (NSW) Pty Ltd AND SHALL NOT BE REPRODUCED OR USED IN ANY MANNER WITHOUT THE PRIOR WRITTEN CONSENT OF TELEPHONE EQUIPMENT (NSW) Pty Ltd

ITEM	SPECIFICATION	
1. Primary rated input voltage	AC240V 50Hz 133mA	
2. Secondary rated output voltage and current	Unloaded voltage: AC 18 V ± 5% Loaded Voltage : AC 16 V ± 5% AT 1500 mA	
3. Ripple voltage	*** mV (RMS) MAX. AT Rated Loading	
4. Insulation resistance	Primary - secondary: DC 500 V 100 MΩ Min	
5. Dielectric withstand test	Primary - secondary: AC 3.64 KV 1 seconds	
6. Temperature rise	At rated loading 90°C max. For input coil (By resistance method) and 55°C max. on case surface (By use of thermometer)	
7. EFFICIENCY	≥ 79%	
8. Leadout	Primary	SAA PLUG IN TYPE
	Secondary	PVC cable length: 1.8 Meter Colour : GREY (RAL7035) Wire size: AWG#20/3C Plug : STRIPPED AND TINNED
9. Test circuit		
10. Case	SAA48 colour = GREY (RAL7035)	

	REVISED	DRAWN	APPROVED
①	AMENDED PACKING QTY AND CARTON SIZE	JACKY 10/08/09	GARY 10/08/09
②	ADDED DATE CODE ON CASE AND DIMENSIONS	JACKY 07/12/09	GARY 07/12/09
③	ADDED PASSED LABEL ON CARTON	TODD 22/12/10	JACKY 22/12/10
④	AMENDED AC PINS DIMENSION & ADDED WIRES COLORS	ANLEI 01/11/12	ANLEI 01/11/12
⑤	CHANGED CROSS-SHAPED SCREW TO SHAPE SCREW ON CASE	MARK 31/08/15	FREDERICK 31/08/15

TE DRAWING NO: TE40-0001 R5

PART NO: 16VAC1500MPS/6

DESCRIPTION: AC ADAPTOR EI-48Q,16VAC1500mA, 3 WIRE - MEPS



THIS DRAWING AND SPECIFICATIONS ARE THE PROPERTY OF TELEPHONE EQUIPMENT (NSW) Pty Ltd AND SHALL NOT BE REPRODUCED OR USED IN ANY MANNER WITHOUT THE PRIOR WRITTEN CONSENT OF TELEPHONE EQUIPMENT (NSW) Pty Ltd

SIZE	A4	DATE	30/04/09	CHECKED	KEVIN 30/04/09		ORDER REF:	0420	SHEET 2 OF 3	TOLERANCES UNLESS OTHERWISE STATED X.= +/- .X= +/-0.5 .XX= +/-0.2
UNIT	MM	DRAWN	KEVIN	APPROVED	FRANK 30/04/09		CUSTOMER:	TE		
SCALE	NTS	MANU:				DATE:				

	REVISED	DRAWN	APPROVED
①	AMENDED PACKING QTY AND CARTON SIZE	JACKY 10/08/09	GARY 10/08/09
②	ADDED DATE CODE ON CASE AND DIMENSIONS	JACKY 07/12/09	GARY 07/12/09
③	ADDED PASSED LABEL ON CARTON	TODD 22/12/10	JACKY 22/12/10
④	AMENDED AC PINS DIMENSION & ADDED WIRES COLORS	ANLEI 01/11/12	ANLEI 01/11/12
⑤	CHANGED CROSS-SHAPPED SCREW TO SHAPE  SCREW ON CASE	MARK 31/08/15	FREDERICK 31/08/15

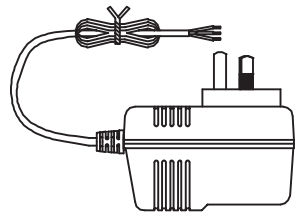

1 PC/WHITE BOX

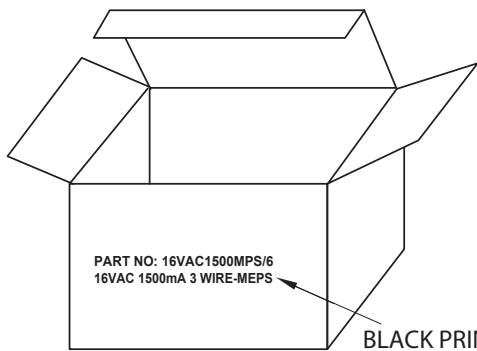

BLACK PRINTING

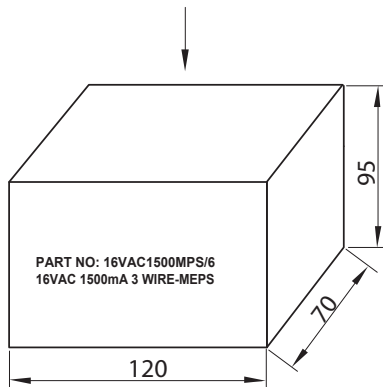

20 BOXES/CARTON ①

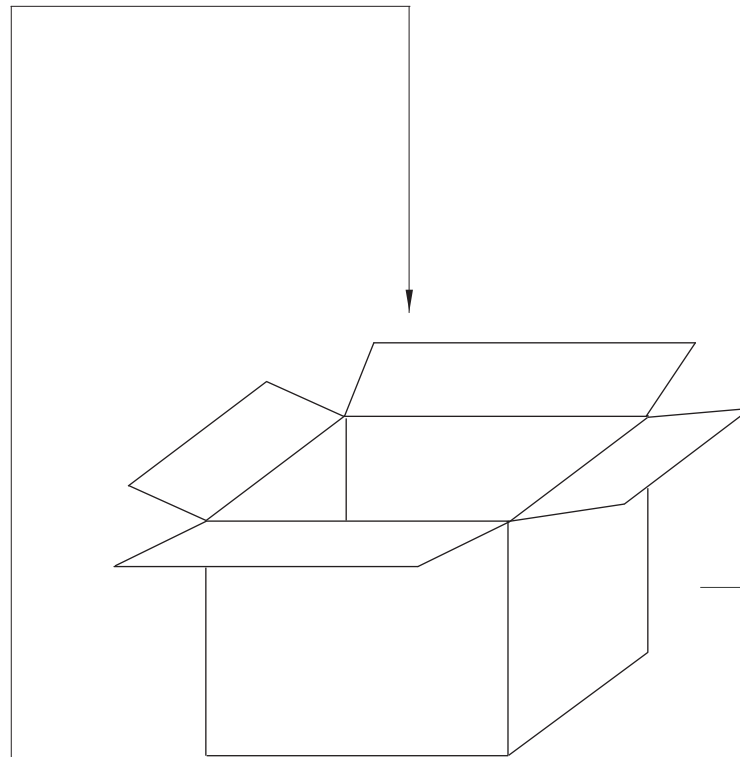

SHIPPING CARTON
PLEASE FOLLOW ORDER TO PRINT SHIPPING MARKS.

ADHESIVE TAPE

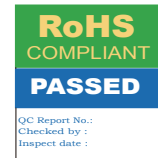
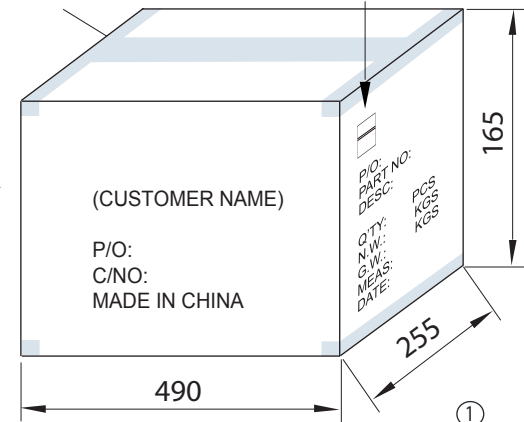

③

ONLY ONE RoHS+PASSED LABEL ON CARTON
RoHS LABEL(5X25MM)
GREEN GROUNDING YELLOW TEXT
PASSED LABEL(5X36MM)
BLUE GROUNDING WHITE TEXT
WHITE GROUNDING BLUE TEXT

①

TE DRAWING NO: TE40-0001 R5

PART NO: 16VAC1500MPS/6

DESCRIPTION: AC ADAPTOR EI-48Q,16VAC1500mA, 3 WIRE - MEPS



THIS DRAWING AND SPECIFICATIONS ARE THE PROPERTY OF TELEPHONE EQUIPMENT (NSW) Pty Ltd AND SHALL NOT BE REPRODUCED OR USED IN ANY MANNER WITHOUT THE PRIOR WRITTEN CONSENT OF TELEPHONE EQUIPMENT (NSW) Pty Ltd

SIZE	A4	DATE	30/04/09	CHECKED	KEVIN 30/04/09		ORDER REF:	0420	SHEET 3 OF 3	TOLERANCES UNLESS OTHERWISE STATED X.= +/-1 .X.= +/-0.5 .XX.= +/-0.2
UNIT	MM	DRAWN	KEVIN	APPROVED	FRANK 30/04/09		CUSTOMER:	TE		
SCALE	NTS	MANU:					DATE:			



Specifications TELLC0280

The TELLC0280 is the telephone lead with 606 Socket and 2 Meter length of Telephone Cord.

Colour: Ivory.

