

Spectra SP Series

4 to 32-Zone Expandable Security Systems

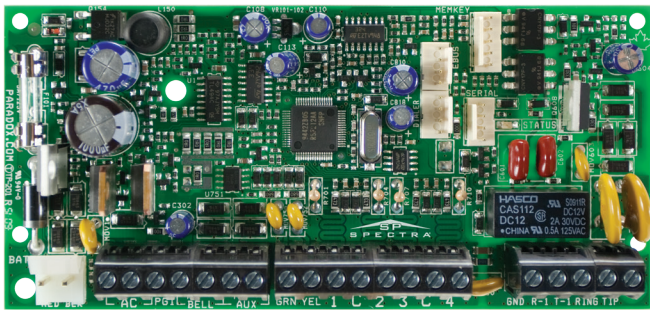

Description

Spectra SP control panels (SP4000, SP5500, SP6000, SP65, and SP7000) offer a combination of innovative features and an advanced communication bus for a uniquely expandable security system. Through its communication bus, all Spectra SP panels can be expanded via wireless and hardwired expansion modules and a variety of accessory modules. With their in-field firmware upgrade capability, the Spectra SP series allows installers to upgrade their system without hassle – quickly, easily, and on-site. To further facilitate installation, every Spectra SP panel can be configured using easy-to-follow, menu-driven programming.

Spectra SP also features multipath communication; this enables your system to communicate through multiple channels, including telephony with its built-in landline dialer, IP with the IP150 Internet Module, IP/GPRS/GSM with the PCS series module, and voice with the VDMP3 Plug-In Voice Module.

With its reliable communication technology, flexible expansion and user-friendly keypads, Spectra SP is the complete residential or commercial security solution.

Features

- Supports StayD mode
- 4-wire expansion bus
- Wireless expansion (via RTX3 / RX1)
- Expandable to 32 zones
- Expandable to 16 PGMs
- 2 partitions
- 32 user codes
- Supports PCS series modules
- Supports IP150 Internet Module
- Supports VDMP3 Plug-in Voice Module
- Supports REM3 Hand-held Remote Keypad
- Supports SR150 Wireless Siren
- Landline dialer (except SP65)
- In-field firmware upgradable

System Overview



Feature Details



Internet Communication (IP150)

The IP150 Internet Module allows you to control and monitor your security system remotely through any web browser. It allows for email notifications of important system events such as alarms, arm/disarm events, and troubles. For example, receive an email at work when your kids get back from school. Also, view the live status of your system and arm/disarm it. For instance, you have just left your office for the weekend but are unsure whether you armed the system. Simply check the status of your system from a laptop and arm it.



Wireless Communication (PCS Series)

The PCS series modules provide the Spectra SP control panels with wireless communication capabilities to report system events via IP, GPRS, and/or GSM. Whether it be uploading/downloading via IP or GPRS, receiving system status and events by voice or text message, or reporting to the monitoring station via IP, GPRS, or GSM, the PCS series enhances the communication capabilities of any Spectra SP installation.



Voice Communication (VDMP3)

The VDMP3 is a plug-in, voice-assisted module that can be programmed to call up to five telephone numbers in the event of an alarm. For example, when an alarm occurs at your store during off-hours, every employee can receive notification via telephone. You can also call the VDMP3 from an outside line, enabling you to arm or disarm the system as well as activate PGMs. The VDMP3 essentially turns any outside telephone into a keypad. The VDMP3 is easy to install; plug it in directly onto the panel, set the phone numbers, and select the activation event.



StayD

StayD resolves all issues with common security systems and represents the only solution for secure living. The revolutionary StayD feature represents a completely reversed philosophy compared to all other security systems made today. Traditional systems share the same principle - in order to provide security, users must remember to arm the system; otherwise the system is disarmed and does not provide security. A StayD system is always armed, and needs only to be partly disarmed when an entry or exit is needed. With StayD, you can truly have peace of mind knowing, that you are always protected.



In-field Upgradable

Spectra SP is not only easy to install, but is also fully in-field upgradable, allowing for simple on-site updates. The process is effortless; connect the PC to the panel and you are a few clicks away from performing a complete system upgrade within minutes. No need to change panels or hardware; all the updates are performed using Paradox's InField Firmware Upgrade Software.



App-based System Control

The Insite GOLD app enables you to remotely access your Paradox security system and view your system cameras. Insite GOLD provides lots of functionality and information at one's fingertip. It has an intuitive user-interface which enables you to easily connect to your security system and edit settings. Now you can control your Paradox security system from any Android / iOS smartphone.

TM70 Overview



TM70: Intuitive Touchscreen

- ## SpotOn Locator™

Upload photos, images, or schematics to eliminate the need for deciphering LED zone lights. These images display any door, window, or motion detector that are active. Since the images are uploaded by the user, they are truly customized, and can be unique to each installation. SpotOn Locator™ is integrated in the original firmware, and when purchased, is unlocked with an authorization code.

- ## OneScreen Monitoring™

Provides a real-time visual display of the system's status on one screen. It allows the user to choose which partitions will be displayed showing arming level, alarm, ready, and troubles. It also displays zone statuses; open, close, bypass, alarm, and tamper. OneScreen Monitoring™ also features Solo Test™ mode, which allows installers and users to easily test all system zone's via the TM70 Touch's screen. OneScreen Monitoring™ is integrated in the original firmware, and when purchased, is unlocked with an authorization code.

Specifications

Display	16-bit, color LCD; 8.6 x 15.4 cm (3.1 x 5.9 in.), 800 x 480 pixels
Input Voltage	9 to 15 Vdc
Current Consumption	250 mA at max brightness + 80 mA sounder
Keypad Zone Input	1 for a detector or external temperature sensor
Tamper	Built-in, cover and wall
Humidity	5 to 90%
Operating Temperature	-10 to 55 °C (14 to 131 °F)
Compatibility	Swan, EVO, Spectra, Magellan

Note: All control panel outputs are rated to operate between 11.4 Vdc and 12.5 Vdc.



Specifications PRX278000033-P2C

The PRX278000033-P2C is a metal box enclosure for provision multiple module and panel mounting.

Features:

- Many punch-out holes for simple wiring
- Easy door removal
- Sizes: 28cm X 28cm X 7.6cm (11" x11" x 3")

P ▲ R ▲ D O X™



Specifications PRXK-TK278

The PRXK-TK278 is a BOM Kit for 1x tamper switch PRX2502302000-P2C and 1x tamper bracket PRX2781030000-P2C to suit with Paradox Metal Box Enclosure PRX2780000033-P2C; to protect against tampering (opening door or removal from wall).

P ▲ R ▲ D O X™

SP5500+ / SP6000+ / SP7000+ User Guide

4 to 32-Zone Expandable Security Systems



P ▲ R ▲ D O X™

NV5

High-Performance Digital Infrared Motion Detector

Description

The NV5 is the entry-level motion detector from Paradox's ENVY line of next generation motion detection. Featuring advanced processing technology, optical technology, and easy installation, the NV5 represents state of the art technology with the most advanced and innovative digital infrared detector of its class.

The NV5 features Paradox's developed optics - a Hybrid Cylindrical / Spherical combination 1.0 inch lens with 3rd generation 3D Lodiff® Fresnel segments- the first and most advanced lens in the detection industry. This combination offers the best detection possible for passive infrared energy reception optimized for far beams (cylindrical) and medium/close beams (spherical). This lens also features Paradox's "Equalized" detection pattern, ensuring equal sensitivity throughout the protected area. Furthermore, the NV5 offers Small Pet Resistance or, alternatively, a Super Creep Zone Mirror add-on optics, which provides superior detection directly below the detector (see Beam Pattern).

The NV5 offers Auto Pulse Signal Processing with two levels of RF rejection, dual or single edge processing, and LED feedback for each setting. With precision and equalized detection, superior detector stability, total area coverage, and complete false alarm protection, the NV5 is the most advanced and innovative digital infrared detector in its class.

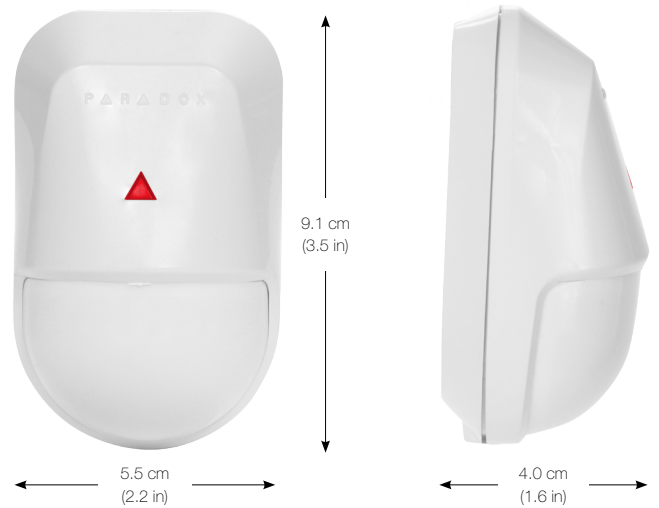

Features

- Infrared motion detector managed by Full Authority Digital Electronics Control (FADEC)
- Paradox's Hybrid Cylindrical-Spherical 1.0 inch lens with 3rd generation 3D Lodiff® Fresnel segments- 10 x 10 m (32.8 x 32.8 ft), 90° viewing angle, and 0.5 m (1.6 ft) to max range (no dead zone beam pattern)
- Paradox's equalized detection pattern - ensures equal sensitivity throughout the protected area
- Paradox Super Creep down-looking beam optic option for straight down detection
- Pet Resistance up to 16 kg (35 lb)
- Dual/Single Edge Processing selection - the only one in its class
- Paradox patented Auto Pulse Signal Processing (APSP) with settings for normal or high interference environments
- Digitally equalized temperature compensation; unit performance specifically tailored to obtain same catch capability at all specified operating temperatures
- Digital Sensitivity trimmer adjustment with five range levels and LED feedback, allows for perfect unit adjustment for all room sizes
- Optional wall/ceiling mount bracket
- Miniature yet easy to install with no PCB removal or adjustment
- CE and EN50131 Grade 2 approved (see PARADOX.com for latest approval updates)
- Interchangeable lenses; 90° standard lens

Advanced Digital Technology (FADEC)

The NV5's digital analysis and algorithms ensure precise and accurate detection performance, managed by Full Authority Digital Electronics Control (FADEC). Depending on the environment application, the NV5 can be easily configured with its unique pre-programmed profile settings (Normal, Moderate, Pet Resistant, and Harsh).

- High-resolution and full-dynamic range digital signal conversion
- High-speed, advanced algorithm, digital signal processing
- Digital EMI / RFI interference rejection
- Five choices of digital range levels (via trimpot)

Advanced Optical Technology

Paradox's Hybrid Cylindrical-Spherical combination offers the best detection possible for passive infrared energy reception for far beams (1. Cylindrical) and medium/close beams (2. Spherical). This lens design allows for ultimate perpendicular beam collection. Superior and uniform energy collection translates to a better image quality of the target which provides unmatched detection accuracy and stability.

- 3rd generation 3D LoDiff® Fresnel segments
- Optically and digitally equalized beam pattern (all beams optimized for generating equal signal level at any distance or angle)
- Optional Super Creep Zone or Pet Resistance up to 16 kg (35 lb)

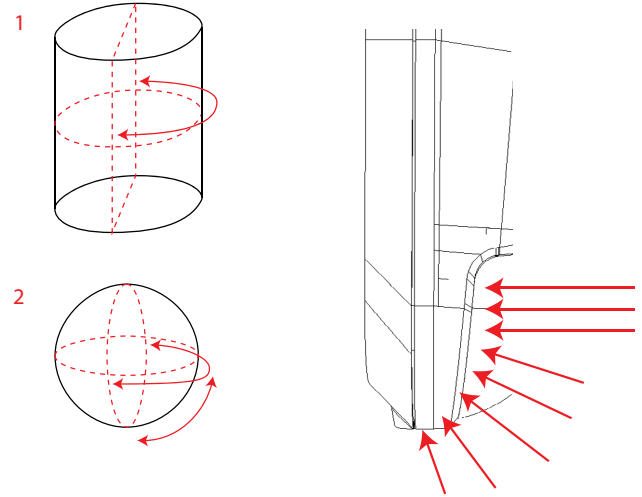

Technical Specifications

Installation height	2.1 m – 3.1 m (7.0 ft – 10.2 ft) For 10 m and above range, unit must be installed at 2.1 m (7.0 ft) height and above
Sensor	Dual rectangular element, low noise, high sensitivity, EMI immunity
Lens	Hybrid Cylindrical Spherical 3 rd gen. Fresnel Lens, equal beam sensitivity (patent pending)
Processing	High resolution digital signal processing. Four profiles (Normal, Medium, Pet Res., Harsh), true digital temperature compensation.
Super Creep Zone	Add on mirror option for enhanced creep zone at 0.1 m from the wall (no Pet Resistance)
Range adjustment	5 level range adjustments (50% to 150%)
Startup time	10 seconds
Detection speed	0.2 m/s to 3 m/s (0.6 ft/s to 9.8 ft/s)
Power input	10 Vdc to 15 Vdc
Current consumption	10.5 mA @ Standby / 11.3 mA @ Alarm
Coverage	10 m (32.8 ft) x 90° 0.5 m (1.6 ft) down looking with optional creep zone
PET Resistance	Up to 16 kg (35 lb)
Alarm indicator	Red LED for 3 seconds
Alarm output	Solid State, N.C. 150 mA
Anti-tamper switch	N.C. 28 Vdc, 0.15 A
Operating temperature	-10°C to 50°C (14°F to 122 °F)
Humidity	95% max.
Dimensions	9.1 x 5.5 x 4 cm (3.5 x 2.2 x 1.6 in.)
RFI Immunity	10 V/m 80 MHz to 2 GHz
Environmental standards	Complies with EN 50131 Security Grade 2 / Environmental Class I

Beam Pattern

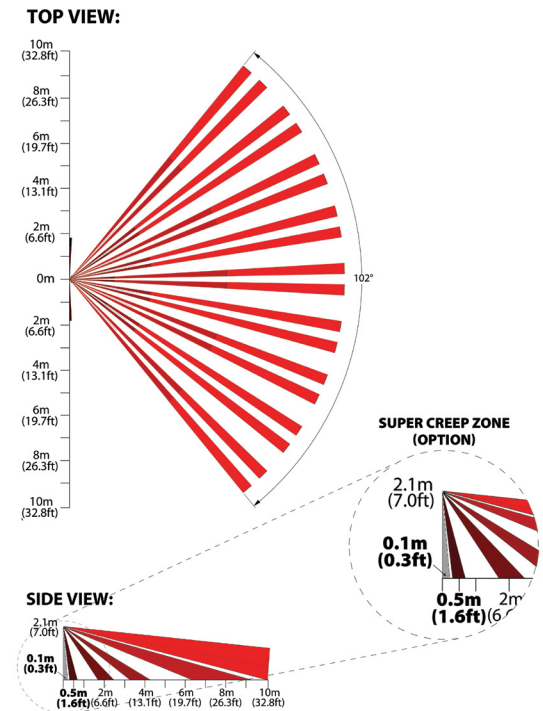

Wall/Ceiling Bracket

Wall Mount Bracket

Ceiling Mount Bracket



TM50 (5") / TM70 (7")

Touch Screen Keypads



TM50 / TM70

The TM50 / TM70 are touch screen input keypads designed to communicate with Paradox control panels, and offer user friendly interface. Both offer vivid colors and two sizes to select, 7" – TM70 or 5" – TM50.

The TM70 due to its larger screen allows for more information to be displayed on one screen and is more convenient in comparison to the TM50.

Both touch screen displays are compatible with Spectra, Magellan and EVO Paradox systems, and both support Paradox next generation Swan panels with RS-485 fast encrypted bus, and features like complete menu programming, remote keypad firmware upgrade and screen saver images download from the Insite GOLD application.

The TM70 / TM50 have screen savers with auto mode, adjustable brightness with auto dim mode and full dark sleep mode, indoor temperature display, bus voltage monitoring and easy multi-partition control.

The TM70 LCD color display resolution is 800 x 400 pixels while the TM50 resolution is 472 x 272 pixels. Both come with an external SD media card (4 GB), 2 GB free space for uploading jpegs for screen savers.

The TM70 is offered in white and the TM50 in white or black colors, other colors may be custom ordered.

Features

- ▶ 7" (TM70) / 5" (TM50) with vivid color display
- ▶ Compatible with Swan, EVO, Spectra and Magellan
- ▶ Built-in zone input
- ▶ Customizable labels (zones, partitions, users, doors and PGMs)
- ▶ External SD Media Card slot (4 GB with 2 GB of free space) for uploading photos; acts like a digital picture frame
- ▶ Firmware upgradable via SD card
- ▶ Indoor temperature reading
- ▶ In-wall bracket (optional)



TM70 installed with in-wall optional bracket

Technical Specifications

	TM70	TM50
Power Input	9 to 15 VDC	
Consumption	250 mA at max brightness + 80 mA sounder	150 mA at max brightness, +80 mA sounder
Wire Connection	18 Gauge	22 Gauge, 18 Gauge recommended
Display	7" 800 x 480	5" 480 x 272
Dimensions	17.7 x 11.4 x 1.5 cm (7 x 4.5 x 0.6 in.)	14.2 x 9.5 x 1.4 cm (5.6 x 3.75 x 0.56 in.)
Humidity	5-90%	
Indoor Temperature	Yes	
SD Card	4 GB; 2 GB free	
Input	Zone, configurable	
Tamper	Built-in, cover and wall	
Compatibility	Swan, EVO, Spectra, Magellan	
Remote Upgrade	Swan only	
Jpeg Download	Swan via Bus, EVO/Spectra SD Card	
Auto Dim	Yes	
Chime	Yes	



P ▲ R ▲ D O X™

TTM70-G2K rev.04 - Printed in Canada 04/2019.
 Specifications may change without prior notice. US, Canadian and international patents may apply. Paradox is a trademark or registered trademark of Paradox Security Systems (Bahamas) Ltd. or its affiliates in Canada, the United States and/or other countries. © 2019 Paradox Security Systems Ltd. All rights reserved.



www.paradox.com



Specifications DFMWP16

The DFMWP16 is combo siren and strobe (slim design).

- New design
- Siren tone selectable for different applications
- Sound volume adjustable: low dB for testing and high dB for normal operation
- Bright: new LED strobe design
- Independent siren and strobe operation
- High quality UV treated case
- Weatherproof
- Front and back tampers
- EOLRs built in, suitable for most major alarm panels

Operating voltage: 9-15VDC

SPL @ 1meter: 110dB

Siren current draw: 150mA

Strobe current draw: 50mA

Siren tone selectable: Tone 1: warble; Tone 2: Hi/Lo

Dimension: 200 x 110 x 40mm





WP16 Combo Siren/Strobe

Voltage: 9-15VDC

Current: Max 150mA @ 12VDC

High Volume: 110±3 dB @ 1meter

Low Volume: 95±3 dB @ 1meter

Tone 1: Warble

Tone 2: Hi/Lo

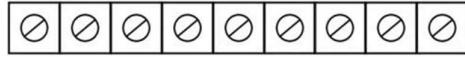
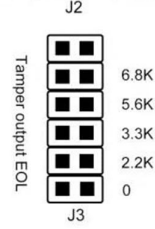
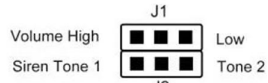

+ Siren - Input + Strobe - Input + LED - Night Comfort Tamper Output Spare





Specifications DFMWP08

The DFMWP08 is indoor top hat piezo.

Input voltage: 12VDC

SPL @ 1meter: 105dB

Current draw: 90mA





VRLA 12V7AH

SA12V7

Specifications

Nominal Voltage	12 V	
Nominal Capacity 20HR	7.0 AH	
Dimensions	Length	151±1mm (5.94 inches)
	Width	65±1mm (2.56 inches)
	Container Height	95±1mm (3.74 inches)
	Total Height (with terminal)	100±1mm (3.94 inches)
Approx Weight	Approx 2.10 kg (4.63 lbs)	
Terminal	F1	
Container Material	ABS Plastic	
Lead Material	Purity Lead 99.995%	
Sulfuric Acid	Distilled Sulfuric Acid (Zero metal content)	
Separator	AGM	
Rated Capacity	7.00 AH/0.350A	(20hr, 1.80V/cell, 25°C/77°F)
	6.53 AH/0.653A	(10hr, 1.80V/cell, 25°C/77°F)
	6.00 AH/1.20A	(5hr, 1.75V/cell, 25°C/77°F)
	5.37 AH/1.79A	(3hr, 1.75V/cell, 25°C/77°F)
	4.55 AH/4.55A	(1hr, 1.60V/cell, 25°C/77°F)
Max. Discharge Current	105A (5s)	
Internal Resistance	Approx 23mΩ	
Operating Temp.Range	Discharge	: -15 - 50°C (5 - 122°F)
	Charge	: 0 - 40°C (32 - 104°F)
	Storage	: -15 - 40°C (5 - 104°F)
Nominal Operating Temp.Range	25±3°C (77±5°F)	
Cycle Use	Initial Charging Current less than 2.1A. Voltage 14.4V - 14.7V at 25°C (77°F) Temp.Coefficient -30mV/°C	
Standby Use	No limit on Initial Charging Current Voltage 13.5V - 13.8V at 25°C (77°F) Temp.Coefficient -20 mV/°C	
Capacity affected by Temperature	40°C (104°F) 103% 25°C (77°F) 100% 0°C (32°F) 86%	
Self Discharge	Sentry AGM series batteries may be stored for up to 6 months at 25°C (77°F) and then a freshening charge is required. For higher temperatures the time interval will be shorter.	



Applications

- All purpose
- Standby Applications
- Recreation Vehicles
- Uninterruptible Power Supply (UPS)
- Electric Power System (EPS)
- Fire & Security
- Generators
- Medical Equipment

Dimensions

F1 Terminal

Unit: mm (inches)

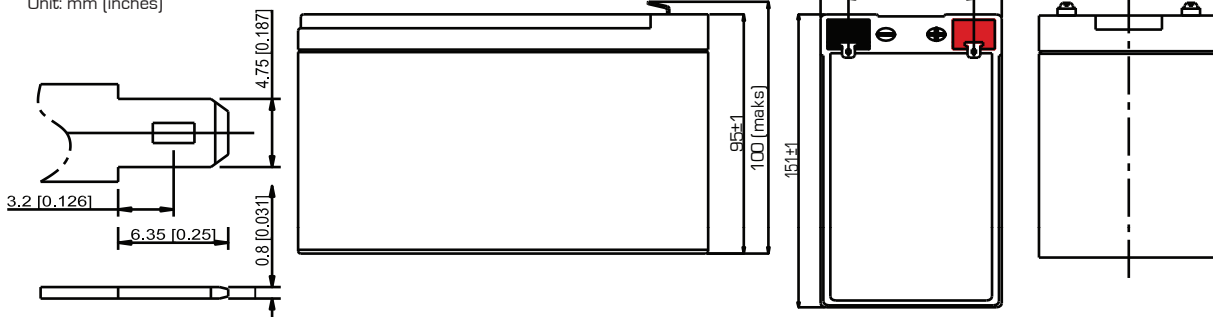

Constant Current Discharge (Amperes) at 25°C (77°F)

F.V./Time	5min	10min	15min	20min	30min	45min	1h	2h	3h	4h	5h	6h	8h	10h	20h
1.85V/cell	18.0	12.8	10.48	8.79	6.53	4.79	3.86	2.29	1.69	1.36	1.14	0.98	0.774	0.640	0.345
1.80V/cell	21.4	14.3	11.4	9.44	6.94	5.05	4.03	2.38	1.74	1.40	1.17	1.01	0.791	0.653	0.350
1.75V/cell	24.2	15.6	12.2	10.0	7.29	5.27	4.18	2.45	1.79	1.43	1.20	1.03	0.805	0.663	0.357
1.70V/cell	26.7	16.7	12.9	10.5	7.59	5.46	4.32	2.51	1.83	1.46	1.22	1.05	0.817	0.672	0.361
1.65V/cell	28.8	17.7	13.5	10.9	7.86	5.62	4.46	2.57	1.86	1.48	1.23	1.06	0.826	0.680	0.365
1.60V/cell	30.6	18.6	14.1	11.3	8.09	5.76	4.55	2.61	1.89	1.50	1.25	1.07	0.834	0.685	0.367

Constant Power Discharge (Watts/Cell) at 25°C (77°F)

F.V./Time	5min	10min	15min	20min	30min	45min	1h	2h	3h	4h	5h	6h	8h	10h	20h
1.85V/cell	34.2	24.5	20.2	17.1	12.8	9.44	7.64	4.56	3.37	2.72	2.29	1.99	1.565	1.296	0.701
1.80V/cell	40.2	27.2	21.9	18.3	13.5	9.91	7.96	4.72	3.47	2.79	2.34	2.03	1.593	1.318	0.708
1.75V/cell	45.1	29.5	23.3	19.3	14.2	10.3	8.23	4.85	3.55	2.85	2.39	2.06	1.616	1.344	0.719
1.70V/cell	49.2	31.3	24.5	20.1	14.7	10.6	8.48	4.96	3.62	2.89	2.42	2.09	1.633	1.347	0.725
1.65V/cell	52.6	32.9	25.5	20.8	15.2	10.9	8.73	5.05	3.68	2.93	2.45	2.11	1.649	1.359	0.731
1.60V/cell	55.5	34.3	26.3	21.5	15.5	11.2	8.88	5.12	3.72	2.96	2.47	2.13	1.660	1.367	0.734

Discharge Characteristics

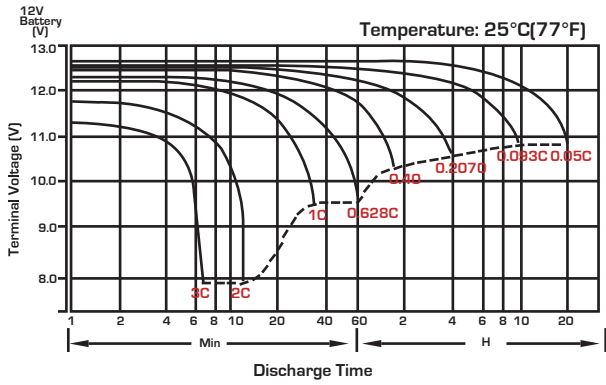

Float Charging Characteristics

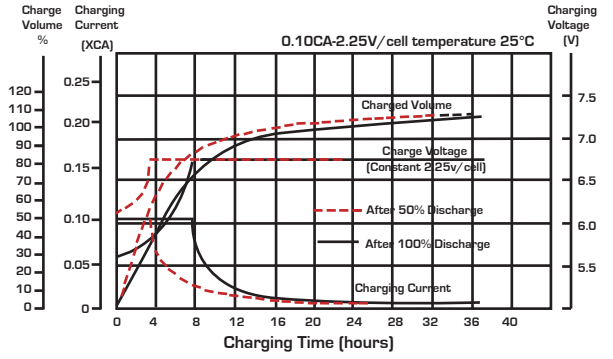

Temperature Effects in Relation to Battery Capacity

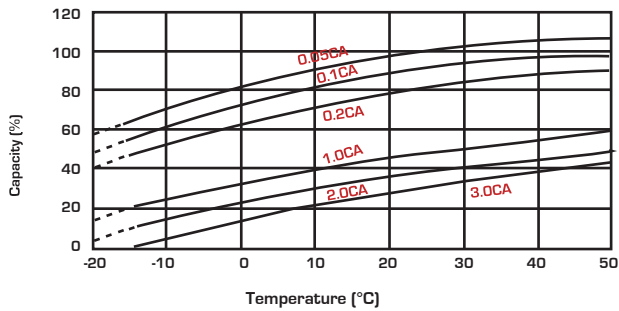

Effect of Temperature on Long Term Float Life

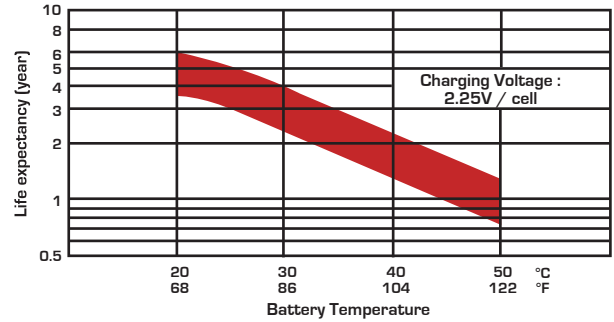

Cycle Life in Relation to Depth of Discharge

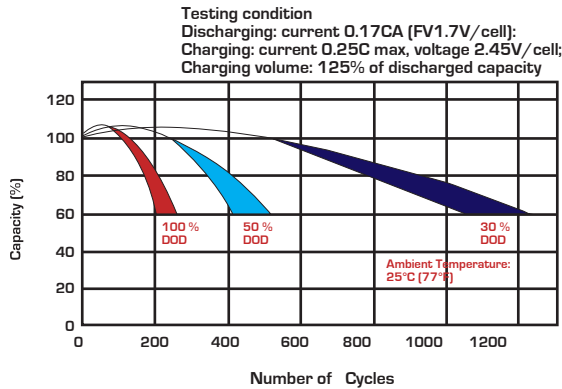

Self Discharge Characteristics

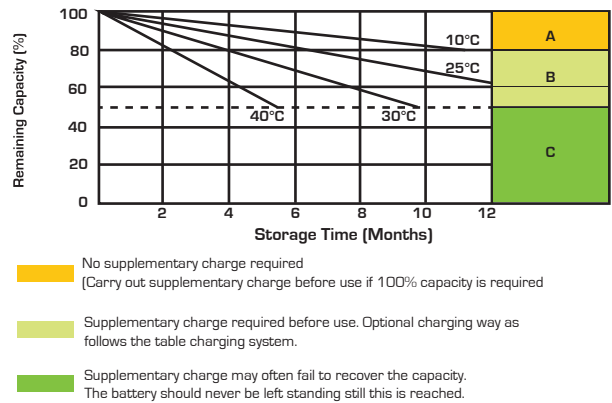

Charging System

DOD	Current Limit (A)	Constant Voltage (V)	Fully Charged Time (h)
20	0.15C ₁₀	13.5-13.8 vpc (12V)	10
	0.20C ₁₀	6.75-6.9 vpc (6V)	8
50	0.15C ₁₀	13.5-13.8 vpc (12V)	15
	0.20C ₁₀	6.75-6.9 vpc (6V)	12
80	0.15C ₁₀	13.5-13.8 vpc (12V)	16
	0.20C ₁₀	6.75-6.9 vpc (6V)	14
100	0.15C ₁₀	13.5-13.8 vpc (12V)	20
	0.20C ₁₀	6.75-6.9 vpc (6V)	18

State of Charge (SOC)

Open Circuit Voltage (V/cell)	Open Circuit Voltage (12V/cell)	Open Circuit Voltage (6V/cell)	State of Charge (% of full charge capacity)
2.14-2.15	12.84-12.90	6.42-6.46	100
2.12-2.13	12.72-12.78	6.36-6.39	90
2.11	12.66	6.33	80
2.09	12.54	6.27	70
2.07	12.42	6.21	60
2.05	12.30	6.15	50



Sealed Performance Batteries

Domestic Sales | Ph: +61 (0)7 3386 1102 | Fax: +61 (0)7 3102 9913
 sales@spb.net.au | www.sealedperformance.com.au
 National Warehouse | 1 Ant Road | Yatala, Brisbane QLD 4207
 Melbourne Office | 2/9 Compark Circuit | Mulgrave, Melbourne VIC 3170

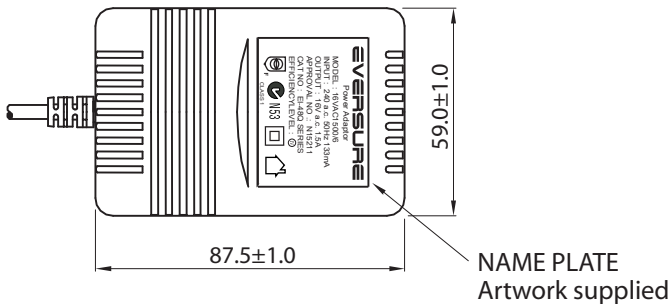
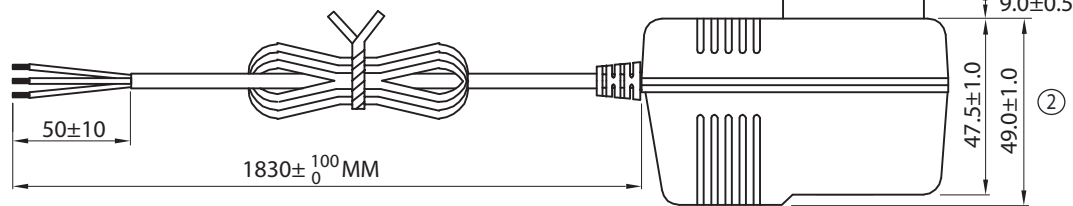
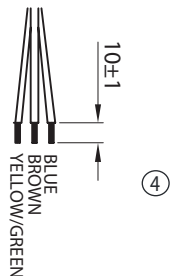

	REVISED	DRAWN	APPROVED
①	AMENDED PACKING QTY AND CARTON SIZE	JACKY 10/08/09	GARY 10/08/09
②	ADDED DATE CODE ON CASE AND DIMENSIONS	JACKY 07/12/09	GARY 07/12/09
③	ADDED PASSED LABEL ON CARTON	TODD 22/12/10	JACKY 22/12/10
④	AMENDED AC PINS DIMENSION & ADDED WIRES COLORS	ANLEI 01/11/12	ANLEI 01/11/12
⑤	CHANGED CROSS-SHAPED SCREW TO SHAPE SCREW ON CASE	MARK 31/08/15	FREDERICK 31/08/15

NOTES:

1. OUTPUT CORD: 20AWGX3C 1.83M Lead Free GREY (RAL7035)
2. CASE: GREY (RAL7035)
3. SECURITY SCREW IS AN ESSENTIAL REQUIREMENT, BOTH "⊥" AND "△" SHAPE ARE ACCEPTABLE

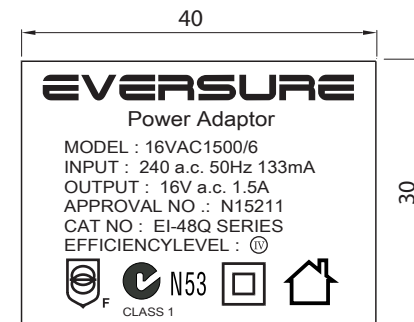

LABEL ARTWORK
Black word on Silver base label

TE DRAWING NO: TE40-0001 R5					PART NO: 16VAC1500MPS/6					
DESCRIPTION: AC ADAPTOR EI-48Q, 16VAC1500mA, 3 WIRE - MEPS										
SIZE	A4	DATE	30/04/09	CHECKED	KEVIN 30/04/09		ORDER REF:	0420	SHEET 1 OF 3	TOLERANCES UNLESS OTHERWISE STATED X.= +/- .X.= +/-0.5 .XX.= +/-0.2
UNIT	MM	DRAWN	KEVIN	APPROVED	FRANK 30/04/09		CUSTOMER:	TE		
SCALE	NTS	MANU:				DATE:				



THIS DRAWING AND SPECIFICATIONS ARE THE PROPERTY OF TELEPHONE EQUIPMENT (NSW) Pty Ltd AND SHALL NOT BE REPRODUCED OR USED IN ANY MANNER WITHOUT THE PRIOR WRITTEN CONSENT OF TELEPHONE EQUIPMENT (NSW) Pty Ltd

ITEM	SPECIFICATION	
1. Primary rated input voltage	AC240V 50Hz 133mA	
2. Secondary rated output voltage and current	Unloaded voltage: AC 18 V ± 5% Loaded Voltage : AC 16 V ± 5% AT 1500 mA	
3. Ripple voltage	*** mV (RMS) MAX. AT Rated Loading	
4. Insulation resistance	Primary - secondary: DC 500 V 100 MΩ Min	
5. Dielectric withstand test	Primary - secondary: AC 3.64 KV 1 seconds	
6. Temperature rise	At rated loading 90°C max. For input coil (By resistance method) and 55°C max. on case surface (By use of thermometer)	
7. EFFICIENCY	≥ 79%	
8. Leadout	Primary	SAA PLUG IN TYPE
	Secondary	PVC cable length: 1.8 Meter Colour : GREY (RAL7035) Wire size: AWG#20/3C Plug : STRIPPED AND TINNED
9. Test circuit	<p>The diagram shows a transformer with a thermal fuse on the primary side. The secondary side is connected to a load circuit containing an ammeter (A), a voltmeter (V), and a variable load resistor.</p>	
10. Case	SAA48 colour = GREY (RAL7035)	

	REVISED	DRAWN	APPROVED
①	AMENDED PACKING QTY AND CARTON SIZE	JACKY 10/08/09	GARY 10/08/09
②	ADDED DATE CODE ON CASE AND DIMENSIONS	JACKY 07/12/09	GARY 07/12/09
③	ADDED PASSED LABEL ON CARTON	TODD 22/12/10	JACKY 22/12/10
④	AMENDED AC PINS DIMENSION & ADDED WIRES COLORS	ANLEI 01/11/12	ANLEI 01/11/12
⑤	CHANGED CROSS-SHAPED SCREW TO SHAPE SCREW ON CASE	MARK 31/08/15	FREDERICK 31/08/15

TE DRAWING NO: TE40-0001 R5

PART NO: 16VAC1500MPS/6

DESCRIPTION: AC ADAPTOR EI-48Q,16VAC1500mA, 3 WIRE - MEPS



THIS DRAWING AND SPECIFICATIONS ARE THE PROPERTY OF TELEPHONE EQUIPMENT (NSW) Pty Ltd AND SHALL NOT BE REPRODUCED OR USED IN ANY MANNER WITHOUT THE PRIOR WRITTEN CONSENT OF TELEPHONE EQUIPMENT (NSW) Pty Ltd

SIZE	A4	DATE	30/04/09	CHECKED	KEVIN 30/04/09		ORDER REF:	0420	SHEET 2 OF 3	TOLERANCES UNLESS OTHERWISE STATED X.= +/- .X.= +/-0.5 .XX.= +/-0.2
UNIT	MM	DRAWN	KEVIN	APPROVED	FRANK 30/04/09		CUSTOMER:	TE		
SCALE	NTS	MANU:				DATE:				

	REVISED	DRAWN	APPROVED
①	AMENDED PACKING QTY AND CARTON SIZE	JACKY 10/08/09	GARY 10/08/09
②	ADDED DATE CODE ON CASE AND DIMENSIONS	JACKY 07/12/09	GARY 07/12/09
③	ADDED PASSED LABEL ON CARTON	TODD 22/12/10	JACKY 22/12/10
④	AMENDED AC PINS DIMENSION & ADDED WIRES COLORS	ANLEI 01/11/12	ANLEI 01/11/12
⑤	CHANGED CROSS-SHAPPED SCREW TO SHAPE  SCREW ON CASE	MARK 31/08/15	FREDERICK 31/08/15

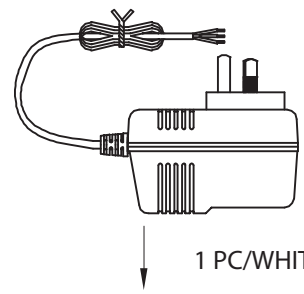

1 PC/WHITE BOX

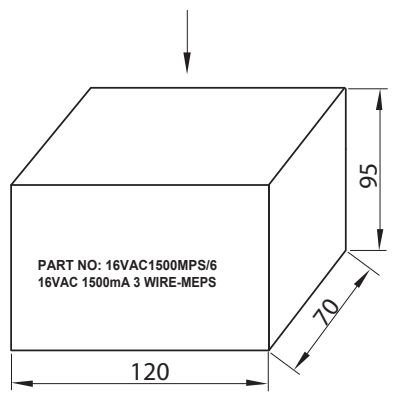
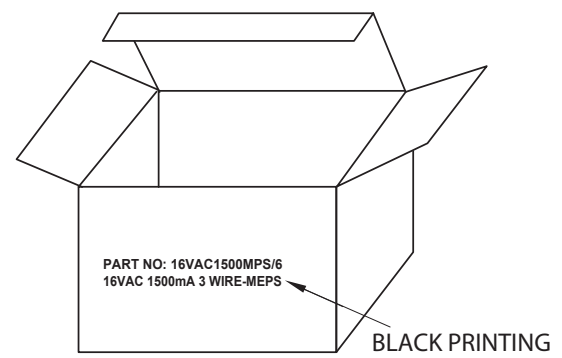

20 BOXES/CARTON ①

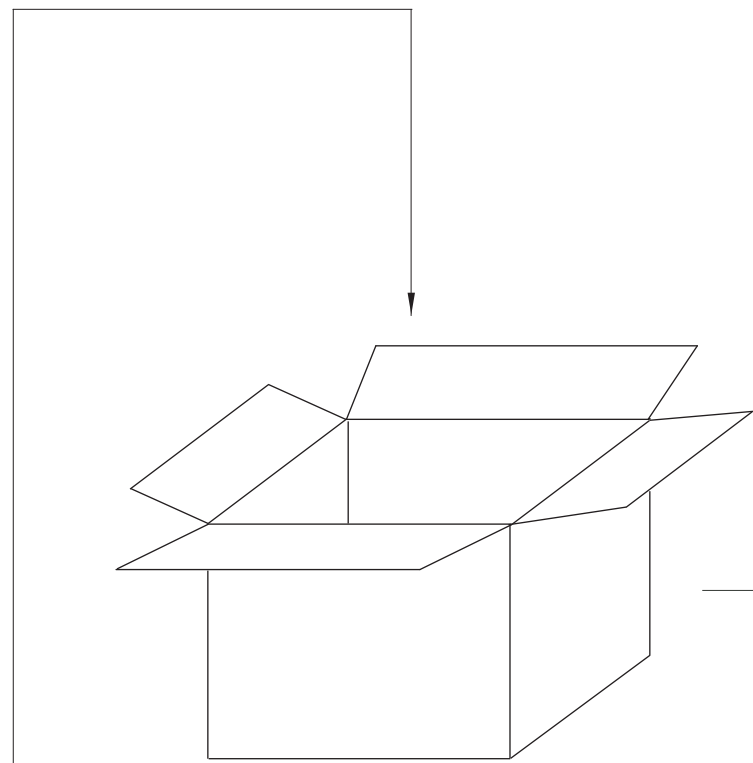

ADHESIVE TAPE

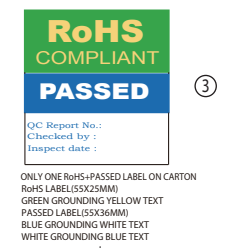
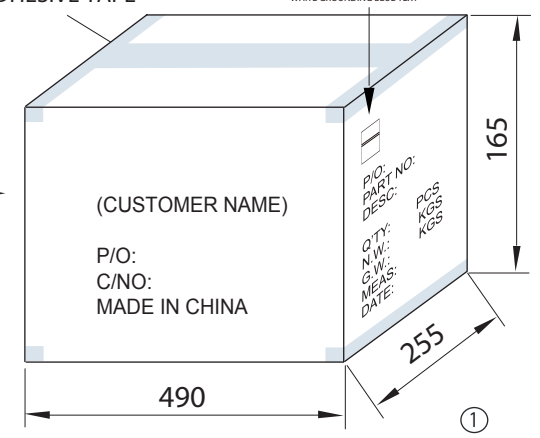

TE DRAWING NO: TE40-0001 R5 PART NO: 16VAC1500MPS/6

DESCRIPTION: AC ADAPTOR EI-48Q,16VAC1500mA, 3 WIRE - MEPS



THIS DRAWING AND SPECIFICATIONS ARE THE PROPERTY OF TELEPHONE EQUIPMENT (NSW) Pty Ltd AND SHALL NOT BE REPRODUCED OR USED IN ANY MANNER WITHOUT THE PRIOR WRITTEN CONSENT OF TELEPHONE EQUIPMENT (NSW) Pty Ltd

SIZE	A4	DATE	30/04/09	CHECKED	KEVIN 30/04/09		ORDER REF:	0420	SHEET 3 OF 3	TOLERANCES UNLESS OTHERWISE STATED X.= +/-1 .X.= +/-0.5 .XX.= +/-0.2
UNIT	MM	DRAWN	KEVIN	APPROVED	FRANK 30/04/09		CUSTOMER:	TE		
SCALE	NTS	MANU:					DATE:			



Specifications TELLC0280

The TELLC0280 is the telephone lead with 606 Socket and 2 Meter length of Telephone Cord.

Colour: Ivory.

