

The new Standard by i-PRO video surveillance

2MP(1080p) IR Indoor Vandal Dome Network Camera with AI Engine

The S-Series network cameras offer a new standard in i-PRO video surveillance with drastically improved image quality with advanced technology. It comes with pre-installed AI analytics applications that detects people and vehicles with accuracy, allowing you to easily start state-of-the-art video surveillance.

The camera can be configured while keeping the unit in the box with the acclaimed "Easy Kitting Packaging", making the installation process smooth and easy.

Key Features

- Drastically improved image quality by advanced technology and AI intelligent Auto
- Pre-installed AI analytics applications to detect human and vehicles. Ready for installing 3rd party applications
- Detecting suspicious sound like Gunshot, Yell, Vehicle horn, and Glass break, with external microphones
- Easy Kitting Package enabling installers to configure cameras easily while keeping the unit in the box
- i-PRO Configuration Tool "iCT" can set up 1024 cameras at the same time.

(iCT page : <https://i-pro.com/global/en/surveillance/tools/ict>)

Key i-PRO Spec.

- 2MP (1080p)
- Intelligent Auto (with AI Engine)
- Super Dynamic 144dB
- Color night vision (0.018 to 0.025 lx)
- Smart Coding (with AI Engine)
- Built-in IR LED
- Vandal Resistant
- ONVIF® Profile G / M / S / T

*ONVIF is a trademark of ONVIF, Inc.

Industry examples

- Airport (Passport control / Security checkpoint / Ticket counter)
- Retail / Bank / Education / Hospital / Building



Specifications

| | | |
|-----------------------------|--|--|
| Camera | Image Sensor | Approx. 1/2.8 type CMOS image sensor |
| | Minimum Illumination | Color : 0.018 lx (30IRE, F1.3, 1/30s) ¹ Color : 0.025 lx (50IRE, F1.3, 1/30s) BW : 0.017 lx (50IRE, F1.3, 1/30s) BW : 0 lx (50IRE, F1.3, 1/30s with IR LED) |
| | White Balance | ATW1 / ATW2 / AWC |
| | Shutter Speed | [60 fps Mode] 1/60 Fix to 1/10000 Fix, [30fps/15fps mode] 1/30 Fix to 1/10000 Fix [50 fps Mode] 1/50 Fix to 1/10000 Fix, [25fps/12.5fps mode] 1/25 Fix to 1/10000 Fix |
| | Intelligent Auto | On / Off |
| | Super Dynamic ² | On / Off, The level can be set in the range of 0 to 31. |
| | Dynamic Range | Max.144 dB (Super Dynamic : On, Level 31) |
| | Adaptive Black Stretch | The level can be set in the range of 0 to 255. |
| | Back light compensation / High light compensation | BLC (Back light compensation) / HLC (High light compensation) / Off (only when Super dynamic / Intelligent Auto : Off) |
| | Fog compensation | On / Off (only when Intelligent auto / auto contrast adjust : Off) |
| | Maximum gain (AGC) | The level can be set in the range of 0 to 11. |
| | Color/BW (ICR) | Off / On (IR Light Off) / On (IR Light On) / Auto1 (IR Light Off) / Auto2 (IR Light On) / Auto3 (SCC) |
| | IR LED Light | High / Middle / Low / Off, Maximum irradiation distance : 50 m (Approx. 164 ft) (50IRE) ¹ 35 m (Approx. 116 ft) (50IRE) |
| | Digital Noise Reduction | The level can be set in the range of 0 to 255. |
| | Video Motion Detection (VMD) | On / Off, 4 areas available |
| | Scene Change Detection (SCD) | On / Off, 1 areas available |
| | Audio Detection | On / Off |
| | AI Sound Classification | Gunshot, Yell, Vehicle horn, Glass break |
| | AI Analytics | Yes |
| | Privacy Zone | On / Off, Up to 8 zones available |
| VIQS | On / Off, Up to 8 zones available | |
| Image rotation ³ | 0 ° / 90 ° / 180 ° / 270 ° | |
| Camera Title (OSD) | On / Off, Up to 40 characters (alphanumeric characters, marks) | |
| Focus Adjustment | Auto focus / Manual | |
| Lens | Optical zoom | 3.1 x (Motorized zoom / Motorized Focus) |
| | Extra zoom | 3.1x - 9.3x (when resolution is 640 x 360) |
| | Focal length | 2.9 - 9 mm [1/8 inches - 11/32 inches] |
| | Angular Field of View | [16:9 mode] Horizontal : 36° (TELE) - 114° (WIDE), Vertical : 20° (TELE) - 60° (WIDE) [4:3 mode] Horizontal : 27° (TELE) - 82° (WIDE), Vertical : 20° (TELE) - 60° (WIDE) |
| | Maximum Aperture Ratio | 1 : 1.3 (WIDE) - 1 : 2.5 (TELE) |
| Focus range | 0.3 m [11-13/16 inches] - ∞ | |
| DORI | Detect (25ppm / 8ppf) | Wide: 24.9 m / 81.8 ft, Tele: 118.2 m / 387.7 ft |
| | Observe (62.5ppm / 19ppf) | Wide: 10.0 m / 32.7 ft, Tele: 47.3 m / 155.1 ft |
| | Recognize (125ppm / 38ppf) | Wide: 5.0 m / 16.4 ft, Tele: 23.6 m / 77.5 ft |
| | Identify (250ppm / 76ppf) | Wide: 2.5 m / 8.2 ft, Tele: 11.8 m / 38.8 ft |
| | Adjusting Angle | Horizontal : -240 to +120°, Vertical : -30 to +85°, Yaw : ±100° |
| Browser GUI | Camera Control | Brightness, AUX On / Off |
| | Audio | Mic (Line) Input : On / Off Volume adjustment : Low / Middle / High Audio Output : On / Off Volume adjustment : Low / Middle / High |
| | GUI / Setup Menu Language | English, Italian, French, German, Spanish, Portuguese, Russian, Chinese, Japanese |
| | Browser ⁴ | Microsoft Edge, Firefox, Google Chrome |
| Network | Network IF | 10Base-T / 100Base-TX, RJ45 connector |
| | Resolution | [16:9 mode (60 fps mode)] ² , [16:9 mode (30 fps mode)], [16:9 mode (50 fps mode)] ² , [16:9 mode (25 fps mode)] 1920x1080, 1280x720, 640x360, 320x180 |
| | H.265/ H.264/ JPEG (MJPEG) | [4:3 mode (30 fps mode)], [4:3 mode (25 fps mode)] 1280x960, VGA, QVGA |
| | H.265/ H.264 ⁶ | [4:3 mode (15 fps mode)], [4:3 mode (12.5 fps mode)] 2048x1536 ⁵ , 1280x960, VGA, QVGA |
| | Transmission Mode | Constant bit rate / VBR / Frame rate / Best effort |
| | Transmission Type | Unicast port (AUTO) / Unicast port (MANUAL) / Multicast |
| | Image Quality | JPEG 10 steps |
| | Smart Coding | GOP (Group of pictures control): Off / Low (Variable GOP 1s-8s) / Mid (Variable GOP 4s-16s) / Advanced (Fixed GOP 60s w/1s key-frame) / Frame rate control (Variable GOP 4s-16s with frame rate control) ⁵ Advanced and Frame rate control are only available with H.265. Smart VIQS: On(High) / On(Low) / Off, Smart P-picture control: On / Off |

| | | |
|----------------------|------------------------------------|---|
| Network | Audio Compression | G.726 (ADPCM) : 16 kbps / 32 kbps G.711 : 64 kbps AAC-LC ⁷ : 64 kbps / 96 kbps / 128 kbps |
| | Audio transmission mode | Off / Mic (Line) input / Audio output / Interactive (Half duplex) / Interactive (Full duplex) |
| Alarm | Supported Protocol | IPv6: TCP/IP, UDP/IP, HTTP, HTTPS, SSL/TLS, SMTP, DNS, NTP, SNMPv1/v2/v3, DHCPv6, RTP, MLD, ICMP, ARP, IEEE 802.1X, DiffServ, SFTP ⁸ , MQTT ⁸ , LLDP ⁸ IPv4: TCP/IP, UDP/IP, HTTP, HTTPS, SSL/TLS, RTSP, RTP, RTSP/RTCP, SMTP, DHCP, DNS, DDNS, NTP, SNMPv1/v2/v3, UPnP, IGMP, ICMP, ARP, IEEE 802.1X, DiffServ, SRTP, SFTP ⁸ , MQTT ⁸ , LLDP ⁸ |
| | No. of Simultaneous Users | Up to 14 users (Depends on network conditions) |
| Input/ Output | SDXC/SDHC/SD Memory Card | H.265 / H.264 recording : Manual REC / Alarm REC (Pre/Post) / Schedule REC / Backup upon network failure JPEG recording : Manual REC / Alarm REC (Pre/Post) / Backup upon network failure Compatible SDXC/SDHC/SD Memory Card : microSDXC memory card: 64 GB, 128 GB, 256 GB, 512 GB microSDHC memory card: 4 GB, 8 GB, 16 GB, 32 GB microSD memory card: 2 GB |
| | Mobile Terminal Compatibility | iPad, iPhone, Android TM terminals |
| General | ONVIF [®] Profile | G / M / S / T |
| | Alarm Source | 3 terminals input, VMD alarm, Command alarm, Audio detection alarm |
| General | Alarm Actions | SDXC/SDHC/SD memory recording, E-mail notification, HTTP alarm notification Indication on browser, TCP alarm notification output |
| | Monitor Output (for adjustment) | VBS : 1.0 V [p-p] / 75 Ω, composite, Pin jack An NTSC or PAL signal can be outputted from camera |
| General | Audio input | Ø3.5 mm stereo mini jack For microphone input : Recommended applicable microphone : Plug-in power type (Sensitivity of microphone : -48 dB±3 dB (0 dB=1 V/Pa, 1 kHz)) Input impedance : Approx. 2 kΩ (unbalanced) Supply voltage : 2.5 V ±0.5 V |
| | Audio Output | For line input : Input level : Approx. -10 dBV Ø3.5 mm stereo mini jack (monaural output) Output impedance : Approx. 600 Ω (unbalanced) Output level : -20 dBV |
| General | External I/O Terminals | ALARM IN 1 (Alarm input 1/ Black & white input/ Auto time adjustment input) (x1) ALARM IN 2 (Alarm input 2/ ALARM OUT) (x1) ALARM IN 3 (Alarm input 3/ AUX OUT) (x1) |
| | Safety | UL (UL62368-1), c-UL (CSA C22.2 No. 62368-1), CE, IEC62368-1 |
| General | EMC | FCC (Part15 ClassA), ICES-003 ClassA, EN55032 ClassB, EN55035 |
| | Power Source and Power Consumption | DC power supply : DC12 V 720 mA, Approx. 8.6 W PoE (IEEE802.3af compliant) Device : DC48 V 180 mA, Approx. 8.7 W (Class 0 device) |
| General | Ambient Operating Temperature | -10 °C to +50 °C (14 °F to 122 °F) |
| | Shock Resistance | IK10 (IEC 62262) |
| General | Ambient Operating Humidity | 10 to 90 % (no condensation) |
| | Dimensions | Ø129.5 mm x 102.5 mm (H) [Ø5-3/32 inches x 4-1/32 inches (H)] Dome radius 41.5 mm [1-5/8 inches] |
| General | Mass (approx.) | 570 g [1.26 lbs.] |
| | Finish | Main body : PC resin, i-PRO white / Dome cover : Polycarbonate resin, Smoke |

¹ Converted value

² When 60 fps or 50 fps is selected, the Super Dynamic function is automatically set to off.

³ When the 60 fps mode, 50 fps mode, 15 fps mode or 12.5 fps mode is used, the "90°" and "270°" settings are not available.
When the 320x180 resolution is used, the "90°" and "270°" settings are not available.

⁴ For information on the operation verification of the supported web browsers, refer to our support website <Control No.: C0132>.

⁵ Used by super resolution techniques.

⁶ Transmission for 4 streams can be individually set.

⁷ When recording audio on an microSD memory card, only use AAC-LC (Advanced Audio Coding - Low Complexity).

⁸ It will be adapted to the products produced after December 2021.

Appearance

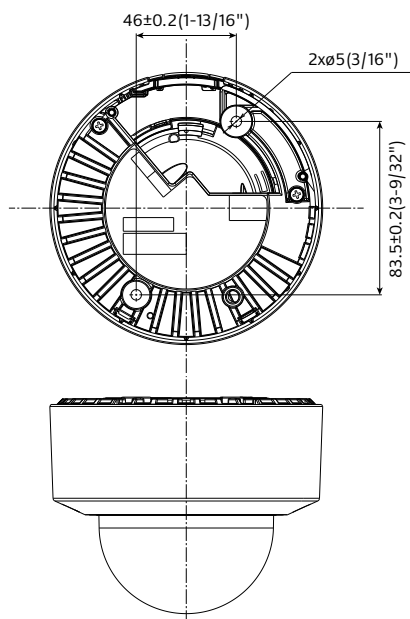
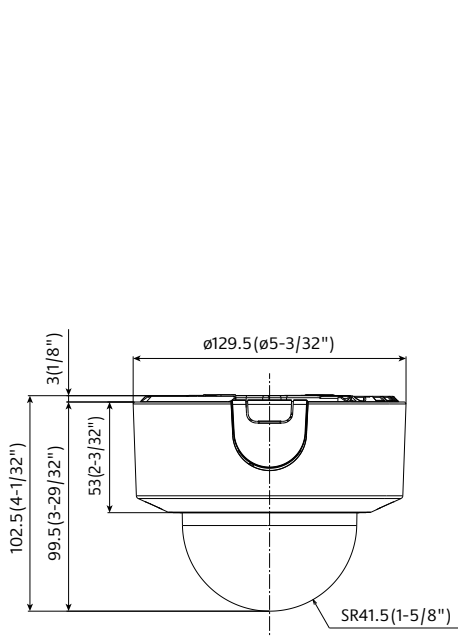

Unit : mm (inches)

AI Analytics applications

<http://i-pro.com/global/en/surveillance/products/i-pro-ai-application>

AI Video Motion Detection (AI-VMD)

Advanced video analysis technology detects objects (faces, people, cars, motorcycles) in a specified area. (Intruder Detection, Loitering Detection, Direction Detection, Cross Line Detection)

AI Privacy Guard

To protect privacy and portrait rights, it is possible to automatically apply a mosaic the entire face and figure of a person photographed by the camera.

AI Face Detection

Detects faces with high precision even in low-light, backlit, and mask-wearing environments.

AI People Detection

Extract the characteristics of human face / clothing and classify them into meaningful categories such as gender, age, and clothing color.

AI Vehicle Detection

Extract vehicle characteristics and classify them into meaningful categories such as type and color.

AI Non mask Detection

Deep-learning and proprietary image processing technologies recognize mask and detect people who are not wearing them.

AI Occupancy Detection











Detecting the congestion via network camera with AI engine enables that information to be used direct visitors in advance or help store staff work more efficiently.

3rd party applications are also available.





<http://i-pro.com/global/en/surveillance/i-pro-application-platform/application-list>

Optional Accessories

Mount Bracket / Other

| combination | WALL | | POLE | CORNER | HANGING | |
|-------------|--|--|--|--|---|--|
| | 1 | 2 | 1 | 1 | 1 | 2 |
| | Wall Mount Bracket WV-QWL501-W (i-PRO white)  | Wall Mount Bracket WV-QWL500-W (i-PRO white)  | Pole Mount Bracket WV-QPL500-W (i-PRO white)  | Corner Mount Bracket WV-QCN500-W (i-PRO white)  | Ceiling Mount Bracket WV-QCL501-W (i-PRO white)  | Ceiling Mount Bracket WV-QCL100-W *1 (i-PRO white)  |
| | Mount Bracket WV-QSR501-W (i-PRO white)  | Adapter Box WV-QJB500-W (i-PRO white)  *If needed. | Wall Mount Bracket WV-QWL500-W (i-PRO white) (+ WV-QJB500-W)  | Wall Mount Bracket WV-QWL500-W (i-PRO white) (+ WV-QJB500-W)  | Mount Bracket WV-QSR501-W (i-PRO white)  | 3rd parties pipe |

*1: It's possible to be used on the camera side and ceiling side. If used on both side, 2pieces are required.

| combination | CEILING | | OTHER |
|-------------|--|---|---|
| | 1 | 2 | 1 |
| | Ceiling Mount Bracket (Embedded) WV-QEM100-W (i-PRO white)  | Ceiling Mount Bracket WV-Q105A  | Attachment pipe (For 3rd party bracket) WV-QAT500-W (i-PRO white)  |
| | / | | Mount Bracket WV-QSR501-W (i-PRO white)  |
| | | | 3rd parties pipe |

Dome Cover

Dome Cover (Smoke type)
WV-CR1S



Trademarks and registered trademarks

- iPad and iPhone are trademarks of Apple Inc., registered in the U.S. and other countries.
- Android is a trademark of Google LLC.
- ONVIF is a trademark of ONVIF, Inc.
- All other trademarks identified herein are the property of their respective owners.

Important

- Safety Precautions : Carefully read the Basic Information, Installation Guide and Operating Instructions before using this product.
- i-PRO Co., Ltd. cannot be held responsible for the performance of the network and/or other manufacturers' products used on the network.
- Masses and dimensions are approximate. • Specifications are subject to change without notice.