

**Preliminary**

## New S-series wide lineup high resolution network camera with AI engine

# 5MP Vandal Resistant Outdoor Dome Network Camera

The 5MP/6MP/4K varifocal lens model, a high-resolution network camera will be added to the lineup of the well-established new S series.

Equipped with an AI processor, it can run up to three AI analytics applications (AI apps) simultaneously, which significantly improve the detection rate of people and vehicles and can be used in a wide range of surveillance scenes.

It realizes high-quality and clearer images even in low-light and wide-range shooting scenes. With the released of total 34 models, including fixed focus, black body, smoke dome, and derivative models such as heavy salt damage resistant models, to support a wide variety of security monitoring applications.

### 3 AI Apps operation at same time

- Up to 3 AI apps can be operated at the same time from the wide variety.

Using AI processor which identifies object as people or vehicle, it will reduce false alarm compared to conventional model.

As result, it can be used many industries.

### High image quality / High compression

- Our original smart coding technology compatible with H.264 and H.265 delivers high-resolution video at high image quality and low bit rate. Achieved useful images by combining with highly visible images by the intelligent auto (iA) function.

### Easy setting and installation

- Easy Kitting Package enabling installers to configure cameras easily while keeping the unit in the box.

The grommet on the outdoor model can reduce the time and effort required for installation.

User-friendly GUI (setting while watching Live view, etc.) allows you to set comfortably.

iCT tool allows you to set multiple cameras, apps, and recorders all at once, reducing the camera setting time.

### High security

- Equipped with FIPS 140-2 level 3 certified hardware in addition to the digital certificate issued by a third party organization (Global Sign).

#### Key i-PRO Spec.

- 5MP
- Intelligent Auto (with AI Engine)
- Super Dynamic 132dB
- Color night vision (0.05 to 0.07 lx)
- Smart Coding (with AI Engine)
- ClearSight Coating
- Built-in IR LED
- Fiber Optic Media Converter Unit (Optional WV-S25F1)
- ONVIF® Profile G / M / S / T

\*ONVIF is a trademark of ONVIF, Inc.

#### Industry examples

- Safe Cities
- Transportation (Airport / Train, Subway station)
- Bank (ATM, Entrance)
- Retail / Logistics / Education / Hospital / Building



## Specifications

<b>Camera</b>	Image Sensor	Approx. 1/2.8 type CMOS image sensor
	Minimum Illumination	Color : 0.05 lx (30IRE, F1.3, 1/30s) <sup>*1</sup> Color : 0.07 lx (50IRE, F1.3, 1/30s) BW : 0.04 lx (50IRE, F1.3, 1/30s) BW : 0 lx (50IRE, F1.3/1/30s with IR LED)
	White Balance	ATW1 / ATW2 / AWC
	Shutter Speed	[30 fps/15 fps mode] 1/30 Fix to 1/10000 Fix [25 fps/12.5 fps mode] 1/25 Fix to 1/10000 Fix
	Intelligent Auto	On / Off
	Super Dynamic <sup>*2</sup>	On / Off. The level can be set in the range of 0 to 31.
	Dynamic Range	Max.132 dB (Super Dynamic : On, Level 31)
	Adaptive Black Stretch	The level can be set in the range of 0 to 255.
	Back light compensation / High light compensation	BLC (Back light compensation) / HLC (High light compensation) / Off (only when Super dynamic / Intelligent Auto : Off)
	Fog compensation	On / Off (only when Intelligent auto / auto contrast adjust : Off)
	Maximum gain (AGC)	The level can be set in the range of 0 to 11.
	Color/BW (ICR)	Off / On (IR Light Off) / On (IR Light On) / Auto1 (IR Light Off) / Auto2 (IR Light On) / Auto3 (SCC)
	IR LED Light	High / Middle / Low / Off, Maximum irradiation distance : 55 m {Approx. 180 ft} (30IRE) <sup>*1</sup> 40 m {Approx. 131 ft} (50IRE)
	Digital Noise Reduction	The level can be set in the range of 0 to 255.
	Video Motion Detection (VMD)	On / Off, 4 areas available
	Scene Change Detection (SCD)	On / Off, 1 areas available
	Audio Detection	On / Off
	AI Sound Classification	Gunshot, Yell, Vehicle horn, Glass break
	AI Analytics	Yes
	Privacy Zone	On / Off, Up to 8 zones available
VIQS	On / Off, Up to 8 zones available	
Image rotation <sup>*3</sup>	0° / 90° / 180° / 270°	
Camera Title (OSD)	On / Off, Up to 40 characters (alphanumeric characters, marks)	
Focus Adjustment	Auto focus	
<b>Lens</b>	Optical zoom	3.1x (Motorized zoom / Motorized Focus)
	Extra zoom	3.1x - 9.3x (when resolution is 853 x 480)
	Focal length	2.9 - 9 mm [1/8 inches - 11/32 inches]
	Angular Field of View	<b>[16 : 9 mode]</b> Horizontal : 33° (TELE) - 103° (WIDE), Vertical : 19° (TELE) - 55° (WIDE) <b>[ 4 : 3 mode]</b> Horizontal : 33° (TELE) - 103° (WIDE), Vertical : 25° (TELE) - 75° (WIDE)
	Maximum Aperture Ratio	1 : 1.3 (WIDE) - 1 : 2.5 (TELE)
Focus range	0.3 m (11-13/16 inches) - ∞	
<b>DORI</b>	Detect (25ppm / 8ppf)	Wide: 48.9 m / 160.3 ft, Tele: 207.4 m / 680.5 ft
	Observe (62.5ppm / 19ppf)	Wide: 19.5 m / 64.1 ft, Tele: 83.0 m / 272.2 ft
	Recognize (125ppm / 38ppf)	Wide: 9.8 m / 32.1 ft, Tele: 41.5 m / 136.1 ft
	Identify (250ppm / 76ppf)	Wide: 4.9 m / 16.0 ft, Tele: 20.7 m / 68.1 ft
<b>Adjusting Angle</b>	Horizontal : -194 to +166°, Vertical : -30 to +85°, Yaw : ±100°	
<b>Browser GUI</b>	Camera Control	Brightness, AUX On / Off
	Audio	Mic (Line) Input : On / Off Volume adjustment : Low / Middle / High Audio Output : On / Off Volume adjustment : Low / Middle / High
	GUI / Setup Menu Language	English, Italian, French, German, Spanish, Portuguese, Russian, Chinese, Japanese
	Browser <sup>*4</sup>	Microsoft Edge, Firefox, Google Chrome
<b>Network</b>	Network IF	10Base-T / 100Base-TX, RJ45 connector
	Resolution	<b>[16:9 mode (30 fps mode)]</b> [16:9 mode (25 fps mode)] 3072x1728/2560x1440/1920x1080/1280x720/640x360/320x180 <b>[4:3 mode (30 fps mode)]</b> [4:3 mode (25 fps mode)] 3072x2304/2560x1920/1280x960/800x600/VGA/400x300/320x240
	H.265/ H.264/ JPEG (MJPEG)	
	H.265/ H.264 <sup>*6</sup>	Transmission Mode Constant bit rate / VBR / Frame rate / Best effort
	JPEG	Transmission Type Unicast port (AUTO) / Unicast port (MANUAL) / Multicast
	JPEG	Image Quality 10 steps

\*1 Converted value

\*2 When 60 fps or 50 fps is selected, the Super Dynamic function is automatically set to off.

\*3 When the 60 fps mode, 50 fps mode, 15 fps mode or 12.5 fps mode is used, the "90°" and "270°" settings are not available. When the 320x180 resolution is used, the "90°" and "270°" settings are not available.

\*4 For information on the operation verification of the supported web browsers, refer to our support website <Control No.: C0132>.

\*5 Used by super resolution techniques

\*6 Transmission for 4 streams can be individually set.

<b>Network</b>	Smart Coding	<b>GOP (Group of pictures control):</b> Off / Low (Variable GOP 1s-8s) / Mid (Variable GOP 4s-16s) / Advanced (Fixed GOP 60s w/1s key-frame) / Frame rate control (Variable GOP 4s-16s with frame rate control) *Advanced and Frame rate control are only available with H.265. <b>Smart VIQS:</b> On(High)/On(Low)/Off, <b>Smart P-picture control:</b> On/Off	
	Audio Compression	G.726 (ADPCM) : 16 kbps / 32 kbps G.711 : 64 kbps AAC-LC <sup>*7</sup> : 64 kbps / 96 kbps / 128 kbps	
	Audio transmission mode	Off / Mic (Line) input / Audio output / Interactive (Half duplex) / Interactive (Full duplex)	
	Supported Protocol	IPv6 : TCP/IP, UDP/IP, HTTP, HTTPS, SSL/TLS, SMTP, DNS, NTP, SNMPv1/v2/v3, DHCPv6, RTP, MLD, ICMP, ARP, IEEE 802.1X, DiffServ, SFTP, MQTT, LLDP IPv4 : TCP/IP, UDP/IP, HTTP, HTTPS, SSL/TLS, RTSP, RTP, RTCP, RTCP, SMTP, DHCP, DNS, DDNS, NTP, SNMPv1/v2/v3, UPnP, IGMP, ICMP, ARP, IEEE 802.1X, DiffServ, SRTP, SFTP, MQTT, LLDP	
	No. of Simultaneous Users	Up to 14 users (Depends on network conditions)	
	SDXC/SDHC/SD Memory Card	H.265 / H.264 recording : Manual REC / Alarm REC (Pre/Post) / Schedule REC / Backup upon network failure JPEG recording : Manual REC / Alarm REC (Pre/Post) / Backup upon network failure Compatible SDXC/SDHC/SD Memory Card : microSDXC memory card : 64 GB, 128 GB, 256 GB, 512 GB microSDHC memory card : 4 GB, 8 GB, 16 GB, 32 GB microSD memory card : 2 GB	
	Mobile Terminal Compatibility	iPad, iPhone (iOS 8.0 or later), Android™ terminals	
	ONVIF <sup>®</sup> Profile	G / M / S / T	
	<b>Alarm</b>	Alarm Source	3 terminals input, VMD alarm, Command alarm, Audio detection alarm
		Alarm Actions	SDXC/SDHC/SD memory recording, E-mail notification, HTTP alarm notification Indication on browser, TCP alarm notification output
<b>Input/ Output</b>	Monitor Output (for adjustment)	VBS : 1.0 V [p-p] / 75 Ω, composite, Pin jack An NTC or PAL signal can be outputted from camera	
	Audio input <sup>*8</sup>	ø3.5 mm stereo mini jack For microphone input : Recommended applicable microphone : Plug-in power type (Sensitivity of microphone : -51 dB to -38 dB (0 dB=1 V/Pa, 1 kHz)) Input impedance : Approx. 2 kΩ (unbalanced) Supply voltage : 2.5 V ±0.5 V For line input : Input level : Approx. -10 dBV	
	Audio Output <sup>*8</sup>	ø3.5 mm stereo mini jack (monaural output) Output impedance : Approx. 600 Ω (unbalanced) Output level : -20 dBV	
	External I/O Terminals <sup>*8</sup>	ALARM IN 1 (Alarm input 1/ Black & white input/ Auto time adjustment input) (x1) ALARM IN 2 (Alarm input 2/ ALARM OUT) (x1), ALARM IN 3 (Alarm input 3/ AUX OUT) (x1)	
<b>General</b>	Safety	UL (UL62368-1), c-UL (CSA C22.2 No.62368-1), CE, IEC62368-1	
	EMC	FCC (Part15 ClassA), IEC-003 ClassA, EN55032 ClassA, EN55035	
	Power Source and Power Consumption	DC power supply <sup>*8</sup> : DC12 V 1.0 A, Approx. 12.0 W PoE (IEEE802.3af compliant) Device : DC48 V 240 mA, Approx. 11.5 W (Class 0 device)	
	Ambient Operating Temperature	-40 °C to +60 °C (-40 °F to 140 °F) <sup>9</sup> (Power On range : -30 °C to +60 °C (-22 °F to +140 °F))	
	Ambient Operating Humidity	10 to 100 % (no condensation)	
	Anti-Condensation System	Temish element + Heater + moisture absorption gel	
	Water and Dust Resistance	IP66, IEC60529 measuring standard compatible, Type 4X(UL50E), NEMA 4X compliant	
	Shock Resistance	IK10 (IEC 62262)	
	Dimensions	ø154 mm x 105 mm (H) [ø6-1/16 inches x 4-1/8 inches (H)]	
	Mass (approx.)	Approx. 1.1 kg [2.43 lbs.]	
Finish	Main body : Aluminum die cast, i-PRO white Outer fixing screws : Stainless steel (Corrosion-resistant treatment) Dome section : Polycarbonate resin, Clear (with ClearSight coating)		

\*7 When recording audio on a microSD memory card, only use AAC-LC (Advanced Audio Coding - Low Complexity).

\*8 When using with these, WV-QCA501A cable is required.

\*9 When using with the IR LED light constantly lit, the upper limit of the operating temperature range is +50 °C [+122 °F].

## Appearance

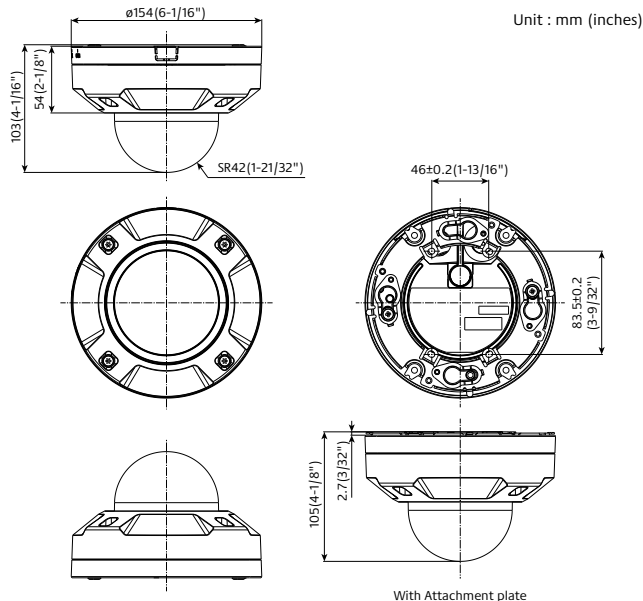

## AI Analytics applications

<https://i-pro.com/global/en/surveillance/products/i-pro-ai-application>

### AI Video Motion Detection (AI-VMD)

Advanced video analysis technology detects objects (faces, people, cars, motorcycles) in a specified area. (Intruder Detection, Loitering Detection, Direction Detection, Cross Line Detection)

### AI Privacy Guard

To protect privacy and portrait rights, it is possible to automatically apply a mosaic the entire face and figure of a person photographed by the camera.

### AI Face Detection

Detects faces with high precision even in low-light, backlit, and mask-wearing environments.

### AI People Detection

Extract the characteristics of human face / clothing and classify them into meaningful categories such as gender, age, and clothing color.

### AI Vehicle Detection

Extract vehicle characteristics and classify them into meaningful categories such as type and color.

### AI Non mask Detection

Deep-learning and proprietary image processing technologies recognize mask and detect people who are not wearing them.

### AI Occupancy Detection

Detecting the congestion via network camera with AI engine enables that information to be used direct visitors in advance or help store staff work more efficiently.

3rd party applications are also available.

<https://i-pro.com/global/en/surveillance/i-pro-application-platform/application-list>

## Optional Accessories

### Fiber Optic Media Converter Unit

Fiber-optic Media Converter Unit Fiber Optic Media Converter Unit supports long distance optical networks by converting copper RJ45 to fiber.

#### WV-S25F1 (Light gray)



#### • Basic specifications

Power source	24 V AC(50 Hz/60 Hz)
Ambient Operating Temperature :	-40 °C to +60 °C (-40 °F to 140 °F) (Power On range: -30 to +60 (-22 °F to 140 °F))
Ambient Operating Humidity :	10 % to 100 % (no condensation)
Waterproof	IP66 (IEC60529)
Shock resistance	IK10 (IEC62262)















\*This unit requires an SFP module.  
\*Refer to website for compatible SFP modules. <https://i-pro.com/global/en/surveillance/training-support/support/technical-information> <Control No. : C0504>

#### • Support specifications for SFP module





SFP Port Type	LC type
Ethernet Speed	100/1000 Mbps
Supply voltage, current	3.3 V typical, Max. 300 mA
SFP Cage	Standard mini-SFP cage (For 6.5 mm pitch SFP)

\*Different Color Model WV-X65F1 (Fine silver)

### Mount Bracket / Other

	WALL			POLE	CORNER	HANGING	
	1	2	3	1	1	1	2
combination	Wall Mount Bracket <b>WV-QWL501-W</b> (i-PRO white) 	Wall Mount Bracket <b>WV-QWL500-W</b> (i-PRO white) 	Sun Shade <b>WV-QSR500-W</b> (i-PRO white) 	Pole Mount Bracket <b>WV-QPL500-W</b> (i-PRO white) 	Corner Mount Bracket <b>WV-QCN500-W</b> (i-PRO white) 	Ceiling Mount Bracket <b>WV-QCL501-W</b> (i-PRO white) 	Ceiling Mount Bracket <b>WV-QCL100-W</b> *1 (i-PRO white)  *For indoor installation only.
	Mount Bracket <b>WV-QSR501-W</b> (i-PRO white) 	Adapter Box <b>WV-QJB500-W</b> (i-PRO white)  *If needed.	Base Bracket <b>WV-QJB501-W</b> (i-PRO white) 	Wall Mount Bracket <b>WV-QWL500-W</b> (i-PRO white) (+ <b>WV-QJB500-W</b> )  + 	Wall Mount Bracket <b>WV-QWL500-W</b> (i-PRO white) (+ <b>WV-QJB500-W</b> )  + 	Mount Bracket <b>WV-QSR501-W</b> (i-PRO white) 	3rd parties pipe

\*1 : It's possible to be used on the camera side and ceiling side. If used on both side, 2pieces are required.

	CEILING			OTHER
	1	2	3	1
combination	Ceiling Mount Bracket (Embedded) <b>WV-QEM500-W</b> (i-PRO white) 	Base Bracket <b>WV-QJB501-W</b> (i-PRO white) 	Ceiling Mount Bracket <b>WV-Q105A</b>  *For indoor installation only.	Attachment pipe (For 3rd party bracket) <b>WV-QAT500-W</b> (i-PRO white) 
				Mount Bracket <b>WV-QSR501-W</b> (i-PRO white) 

### Dome Cover

Dome Cover (Smoke type) <b>WV-CW7S</b> 	Dome Cover (Smoke type with ClearSight coating) <b>WV-CW7SN</b> 	Dome Cover (Clear type with ClearSight coating) <b>WV-CW7CN</b> 
---	--	--

### Cable

RJ45 Ethernet Cable <b>WV-QCA500A</b> <b>WV-QCA500APK</b> 	I/O Cable <b>WV-QCA501A</b> <b>WV-QCA501APK</b> 
--	---

\*WV-QCA500APK and WV-QCA501APK are package of 10 cables.

\*The color of the grommet rubber may differ depending on the production time, but the performance and mounting method will not change.

#### Trademarks and registered trademarks

- iPad and iPhone are trademarks of Apple Inc., registered in the U.S. and other countries.
- Android is a trademark of Google LLC.
- ONVIF is a trademark of ONVIF, Inc.
- All other trademarks identified herein are the property of their respective owners.

#### Important

- Safety Precautions : Carefully read the Basic Information, Installation Guide and Operating Instructions before using this product.
- i-PRO Co., Ltd. cannot be held responsible for the performance of the network and/or other manufacturers' products used on the network.
- Masses and dimensions are approximate. • Specifications are subject to change without notice.