

i-PRO

WV-U65301-Z1 WV-U65301-Z1G

U series PTZ camera

2MP (1080p) 10x Outdoor PTZ Network Camera

U-Series launch gives customers PTZ's that meet top security certifications (FIPS 140-2 level 3) while also providing a unique blend of imaging performance, reliability and affordability.

Highly durable pan-tilt drive unit Reduced maintenance costs

- High durability gear drive achieves PAN and TILT drive durability (3.7 million movements). Low failure rate even with high frequency drive and reduced maintenance cost by minimizing the maintenance cycle.

Easy installation

- U-series compact PTZ cameras can be installed discreetly and easily on low ceilings.
- Easy kitting packaging allows the camera to be set up without removing it from the box during kitting prior to installation.
- The x21 and x10 models of the U-Series outdoor DOME are shipped with a waterproof LAN extension cable installed. The DOME can be installed without opening the DOME at sites where conventional pigtailed are used.
- The addition of a diverse lineup of mounting brackets and optional PoE injectors enables flexible installation regardless of the location of new or existing installations.

High security standard

- Highest level of security. In addition to digital certificates issued by a third-party organization (GlobalSign®), FIPS 140-2 level3-certified hardware is installed.

Key i-PRO Spec.

- 2MP (1080p) 1920x1080
- 10x optical zoom
- Intelligent Auto
- Super Dynamic 144dB
- Color night vision (0.001 to 0.015 lx) (G: 0.003 to 0.045 lx)
- Durable Pan/Tilt gear mechanism
- IP66, IK10 certified
- ONVIF® Profile G / S / T *ONVIF is a trademark of ONVIF, Inc.
- FIPS 140-2 level3 certified

Industry examples

- Safe Cities
- Transportation (Airport / Train, Subway station)
- Parking
- Critical infrastructure



WV-U65301-Z1



WV-U65301-Z1G (Smoke Dome)



Specifications

Camera	Image Sensor	Approx. 1/2.8 type CMOS image sensor	
	Minimum Illumination	Color : 0.015 lx (G: 0.045 lx) (50IRE, F1.6, 1/30s) Color : 0.001 lx (G: 0.003 lx) (50IRE, F1.6, 16/30s)*1 BW : 0.006 lx (G: 0.017 lx) (50IRE, F1.6, 1/30s) BW : 0.0004 lx (G: 0.0011 lx) (50IRE, F1.6, 16/30s)	
	White Balance	ATW1 / ATW2 / AWC	
	Shutter Speed	[60 fps Mode] 1/60 Fix to 1/10000 Fix, [30 fps/15 fps mode] 1/30 Fix to 1/10000 Fix [50 fps Mode] 1/50 Fix to 1/10000 Fix, [25 fps/12.5 fps mode] 1/25 Fix to 1/10000 Fix	
	Intelligent Auto	On / Off	
	Super Dynamic*2	On / Off, The level can be set in the range of 0 to 31.	
	Dynamic Range	Max.144 dB (Super Dynamic : On, Level 31)	
	Adaptive Black Stretch	The level can be set in the range of 0 to 255.	
	Back light compensation / High light compensation	BLC (Back light compensation) / HLC (High light compensation) / Off The level can be set in the range of 0 to 31 (only when Super dynamic / Intelligent Auto : Off)	
	Fog compensation	On / Off, The level can be set in the range of 0 to 8 (only when intelligent auto / auto contrast adjust : Off)	
	Maximum gain (AGC)	The level can be set in the range of 0 to 11.	
	Color/BW (ICR)	Off / On / Auto1 / Auto2 / Auto3 (SCC)	
	Digital Noise Reduction	The level can be set in the range of 0 to 255.	
	Video Motion Detection (VMD)	On / Off, 4 areas available	
	Scene Change Detection (SCD)	On / Off, 1 areas available	
	Audio Detection	On / Off	
	AI Sound Classification	—	
	AI Analytics	—	
	Privacy Zone	On / Off, Up to 32 zones available	
	VIQS	On / Off, Up to 8 zones available	
Image Stabilizer	On / Off		
Camera Title (OSD)	On / Off, Up to 40 characters (alphanumeric characters, marks)		
Focus Adjustment	Auto focus		
Lens	Optical zoom	10x (Motorized zoom / Motorized Focus)	
	Extra zoom	Max. 15x (10 to 15x : When resolution is 1280 x 720)	
	Focal length	4.7 - 47 mm [3/16 inches - 1-27/32 inches]	
	Angular Field of View	[16 : 9 mode] Horizontal : 6.7° (TELE) - 62° (WIDE), Vertical : 3.8° (TELE) - 37° (WIDE) [4 : 3 mode] Horizontal : 5.1° (TELE) - 48° (WIDE), Vertical : 3.8° (TELE) - 37° (WIDE)	
	Maximum Aperture Ratio	1 : 1.6 (WIDE) - 1 : 3.0 (TELE)	
DORI	Detect (25ppm / 8ppf)	Wide: 64.2 m / 210.5 ft, Tele: 656.0 m / 2152.3 ft	
	Observe (62.5ppm / 19ppf)	Wide: 25.7 m / 84.2 ft, Tele: 262.4 m / 860.9 ft	
	Recognize (125ppm / 38ppf)	Wide: 12.8 m / 42.1 ft, Tele: 131.2 m / 430.5 ft	
	Identify (250ppm / 76ppf)	Wide: 6.4 m / 21.1 ft, Tele: 65.6 m / 215.2 ft	
System on Chip (SoC)	Ambarella CV25M		
Adjusting Angle	Horizontal : 360° Endless Panning, Vertical : -15° to +195°, Yaw : 0°		
Pan/tilt	Panning Range	360° Endless Panning	
	Panning Speed	Manual: Approx. 0.065°/s - 150°/s Preset: Up to approx. 500°/s	
	Tilting Range	Operational -15° - +195°	
	Tilting Speed	Manual: Approx. 0.065°/s - 150°/s Preset: Up to approx. 500°/s (PoE+), Up to approx. 350°/s (DC12 V PoE)	
	Preset Positions	256 positions	
	Auto Mode	Auto pan/ Preset sequence/ Patrol	
	Self Return	10 s / 20 s / 30 s / 1 min / 2 min / 3 min / 5 min / 10 min / 20 min / 30 min / 60 min	
Browser GUI	Camera Control	Brightness, AUX On / Off	
	Audio	Mic (Line) Input : On / Off Volume adjustment : Low / Middle / High Audio Output : On / Off Volume adjustment : Low / Middle / High	
	GUI / Setup Menu Language	English, Italian, French, German, Spanish, Portuguese, Russian, Chinese, Japanese	
	Browser*3	Microsoft Edge, Firefox, Google Chrome	
Network	Network IF	10Base-T / 100Base-TX, RJ45 connector	
	Resolution	[16 : 9 mode (60 fps mode)] *2, [16 : 9 mode (30 fps mode)] , [16 : 9 mode (50 fps mode)] *2, [16 : 9 mode (25 fps mode)] 1920x1080, 1280x720, 640x360, 320x180	
	H.265 / H.264 / JPEG (MJPEG)	[4 : 3 mode (30 fps mode)] , [4 : 3 mode (25 fps mode)] 1280x960, VGA, QVGA [4 : 3 mode (15 fps mode)] , [4 : 3 mode (12.5 fps mode)] 2048x1536*4, 1280x960, VGA, QVGA	
	H.265 / H.264*5 / JPEG	Transmission Mode	Constant bit rate / VBR / Frame rate / Best effort
	Transmission Type	Unicast port (AUTO) / Unicast port (MANUAL) / Multicast	
	Image Quality	10 steps	

Network	Smart Coding	GOP (Group of pictures) control: Off / Low (Variable GOP 1s-8s) / Mid (Variable GOP 4s-16s) / Advanced (Fixed GOP 60s w/1s key-frame) / Frame rate control (Variable GOP 4s-16s with frame rate control) *Advanced and Frame rate control are only available with H.265. Smart Coding: Auto VIQS: On/Off
	Audio Compression	G.726 (ADPCM) : 16 kbps / 32 kbps G.711 : 64 kbps AAC-LC*6 : 64 kbps / 96 kbps / 128 kbps
	Audio transmission mode	Off / Mic (Line) input / Audio output / Interactive (Half duplex) / Interactive (Full duplex)
	Supported Protocol	IPv6 : TCP/IP, UDP/IP, HTTP, HTTPS, SSL/TLS, SMTP, DNS, NTP, SNMPv1/v2/v3, DHCPv6, RTP, MLD, ICMP, ARP, IEEE 802.1X, DiffServ IPv4 : TCP/IP, UDP/IP, HTTP, HTTPS, SSL/TLS, RTSP, RTP, RTSP/RTCP, SMTP, DHCP, DNS, DDNS, NTP, SNMPv1/v2/v3, UPnP, IGMP, ICMP, ARP, IEEE 802.1X, DiffServ, SRTP, MQTT, NTCP
	No. of Simultaneous Users	Up to 14 users (Depends on network conditions)
	Secure	FIPS 140-2 level3, Device Certificate GlobalSign® pre-installed
	SDXC/SDHC/SD Memory Card	H.265 / H.264 recording : Manual REC / Alarm REC (Pre/Post) / Schedule REC / Backup upon network failure JPEG recording : Manual REC / Alarm REC (Pre/Post) / Backup upon network failure Compatible SDXC/SDHC/SD Memory Card : microSDXC memory card : 64 GB, 128 GB, 256 GB, 512 GB microSDHC memory card : 4 GB, 8 GB, 16 GB, 32 GB microSD memory card : 2 GB
	Mobile Terminal Compatibility	iPad, iPhone (iOS 8.0 or later), Android™ terminals
	ONVIF® Profile	G / S / T
	Alarm	Alarm Source
Alarm Actions		SDXC/SDHC/SD memory recording, E-mail notification, HTTP alarm notification Indication on browser, TCP alarm notification output
Input/Output	Audio input	Ø3.5 mm stereo mini jack For microphone input : Recommended applicable microphone : Plug-in power type (Sensitivity of microphone : -51 dB to -38 dB (0 dB=1 V/Pa, 1 kHz)) Input impedance : Approx. 2 kΩ (unbalanced) Supply voltage : 2.5 V ±0.5 V
	Audio Output	For line input : Input level : Approx. -10 dBV Ø3.5 mm stereo mini jack (monaural output) Output impedance : Approx. 600 Ω (unbalanced) Output level : -20 dBV
General	External I/O Terminals	ALARM IN 1 (Alarm input 1/ Alarm & white input/ Auto time adjustment input) (x1) ALARM IN 2 (Alarm input 2/ ALARM OUT) (x1), ALARM IN 3 (Alarm input 3/ AUX OUT) (x1)
	Safety	UL (UL62368-1), c-UL (CSA C22.2 No.62368-1), CE, IEC62368-1
EMC	EMC	FCC (Part15 ClassA), ICES-003 Issue 7 ClassA, EN55032 ClassA, EN55035
	Power Source and Power Consumption	DC12 V, PoE (IEEE802.3af), PoE+ (IEEE802.3at)
		DC12 V: 1.3 A / Approx.15.6 W PoE DC 48 V: 270 mA / Approx.12.95 W (Class 0 device) PoE+ DC 54 V: 340 mA / Approx18.4 W(Class 4 device)
	Ambient Operating Temperature	-30 °C to +55 °C (-22 °F to +131 °F) (Power On range : -20 °C to +55 °C {-4 °F to +131 °F}) Maximum temperature according to NEMA TS2(2.2.7) : 74 °C(165 °F)
	Ambient Operating Humidity	10 to 100 % (no condensation)
	Anti-Condensation System	Temish element
	Water and Dust Resistance	IP66, IEC60529 measuring standard compatible, Type 4X(UL50E), NEMA 4X compliant
	Shock Resistance	IK10 (IEC 62262)
	Other standard support	NEMA TS2(2.2.7-2.2.9)
	Dimensions	Ø165 mm x 139 mm (H) {Ø6-1/2 inches x 5-15/32 inches (H)}
Mass (approx.)	Approx. 1.6 kg (3.53 lbs.)	
Finish	Main body : Aluminum die cast, Black polycarbonate resin, i-PRO white Outer fixing screws : Stainless steel (Corrosion-resistant treatment) Dome section : Polycarbonate resin, Clear (G: Smoke)	

*1 Converted value
*2 When 60 fps or 50 fps is selected, the Super Dynamic function is automatically set to off.
*3 For information on the operation verification of the supported web browsers, refer to our support website <Control No.: C0132>.
*4 Used by super resolution techniques
*5 Transmission for 4 streams can be individually set.
*6 When recording audio on a microSD memory card, only use AAC-LC (Advanced Audio Coding - Low Complexity).

Appearance

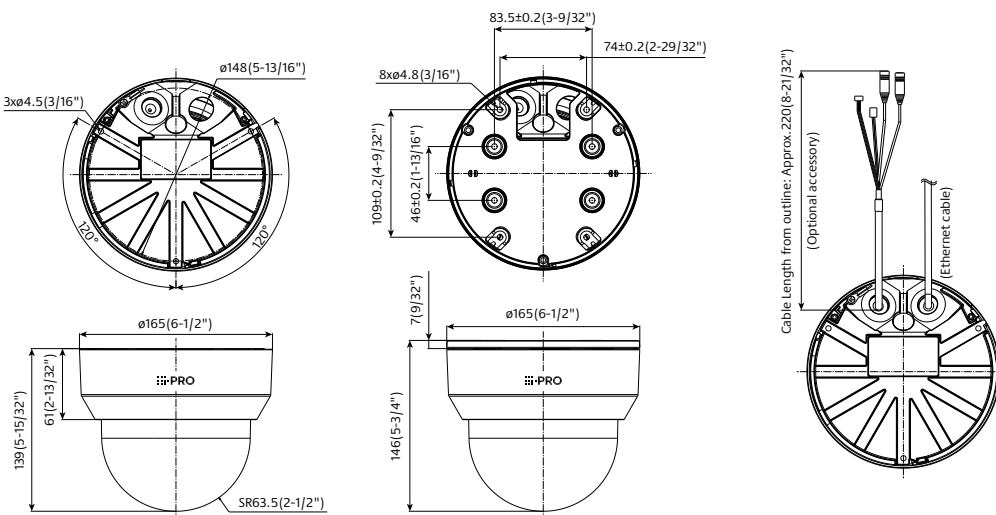













Unit : mm (inches)





With Attachment plate & Attachment cover

Optional Accessories

Mount Bracket / Other

	WALL		POLE	CORNER	HANGING	
	1	2	1	1	1	2
combination	Wall Mount Bracket WV-QWL501-W (i-PRO white) 	Wall Mount Bracket WV-QWL500-W (i-PRO white) 	Pole Mount Bracket WV-QPL500-W (i-PRO white) 	Corner Mount Bracket WV-QCN500-W (i-PRO white) 	Ceiling Mount Bracket WV-QCL501-W (i-PRO white) 	Ceiling Mount Bracket WV-QCL100-W *1 (i-PRO white)  <small>*For indoor installation only.</small>
	Mount Bracket WV-QSR501-W (i-PRO white) 	Adapter Box WV-QJB500-W (i-PRO white)  <small>*if needed.</small>	Wall Mount Bracket WV-QWL501-W (i-PRO white) 	Wall Mount Bracket WV-QWL501-W (i-PRO white) 	Mount Bracket WV-QSR501-W (i-PRO white) 	
			Mount Bracket WV-QSR501-W (i-PRO white) 	Mount Bracket WV-QSR501-W (i-PRO white) 		

*1: It's possible to be used on the camera side and ceiling side. If used on both side, 2pieces are required.

	CEILING			OTHER
	1	2	3	1
combination	Base Bracket WV-QJB501-W (i-PRO white) 	Ceiling Mount Bracket (Embedded) WV-QEM503-W (i-PRO white)  <small>*For indoor installation only.</small>	Base bracket WV-QJB504-W (i-PRO white) 	3rd Party Pipe (Male or Female type)
				Mount Bracket WV-QSR501F-W (i-PRO white, ISO Female thread)  WV-QSR501M-W (i-PRO white, ISO Male thread) 

Dome Cover

Dome Cover (Smoke type)
WV-QDC502G



Cable

I/O Cable
WV-QCA501A
WV-QCA501APK



*WV-QCA501APK is package of 10 cables.

*The color of the grommet rubber may differ depending on the production time, but the performance and mounting method will not change.

Trademarks and registered trademarks

- GlobalSign and the GlobalSign Logo are registered trademarks of GMO GlobalSign K.K.
- iPad and iPhone are trademarks of Apple Inc., registered in the U.S. and other countries.
- Android is a trademark of Google LLC.
- ONVIF is a trademark of ONVIF, Inc.
- All other trademarks identified herein are the property of their respective owners.

Important

- Safety Precautions : Carefully read the Basic Information, Installation Guide and Operating Instructions before using this product.
- i-PRO Co., Ltd. cannot be held responsible for the performance of the network and/or other manufacturers' products used on the network.
- Masses and dimensions are approximate. • Specifications are subject to change without notice.